

DXN

Hazardous Location plug and receptacle



Main Advantages

- ▶ Easy to handle due to compact, lightweight design
- ▶ Available in in-line and wall/panel mounted configurations
- ▶ CSA, ATEX and IECEx certified for use in Zones 1 and 2 (gas) and Zones 21 and 22 (dust)



Watch the DXN
video and other
product videos at
meltric.com/video

- | | | | |
|----------------------------|--------|--------------|--------|
| ▶ Features & Ratings | p. 187 | ▶ DXN30 | p. 192 |
| ▶ Certifications & Testing | p. 188 | ▶ DXN60 | p. 194 |
| ▶ Operation | p. 189 | ▶ Dimensions | p. 196 |
| ▶ DXN20 | p. 190 | | |

PRODUCT FEATURES



Pushbutton Pawl/OFF Button

Provides quick, safe and easy current interruption.

Silver-Nickel Contacts

Silver-nickel contact material provides superior conductivity, durability and corrosion resistance.

Hazardous Location Termination Areas

Includes enhanced creepage and clearance distances and specially designed terminals to ensure perfect and permanent clamping.

Casing

Self-extinguishing, non-static, material provides outstanding resistance to mechanical abuse and chemicals.

Lid

When closed, the lid maintains IP66/IP67 protection for the receptacle after removal of the plug.

Spring-Loaded Butt-Style Contacts

Ensures optimal contact force and superior electrical performance over thousands of operations.

Arc Isolation Chamber

Minimizes gas/dust volume present during arcing, withstands internal pressure due to ignition of it and isolates the ignition from the outside environment.

Arc-Extinguishing Flame Path

Dissipates internal pressure created during arcing while also preventing any associated ignition sources from reaching the surrounding atmosphere.

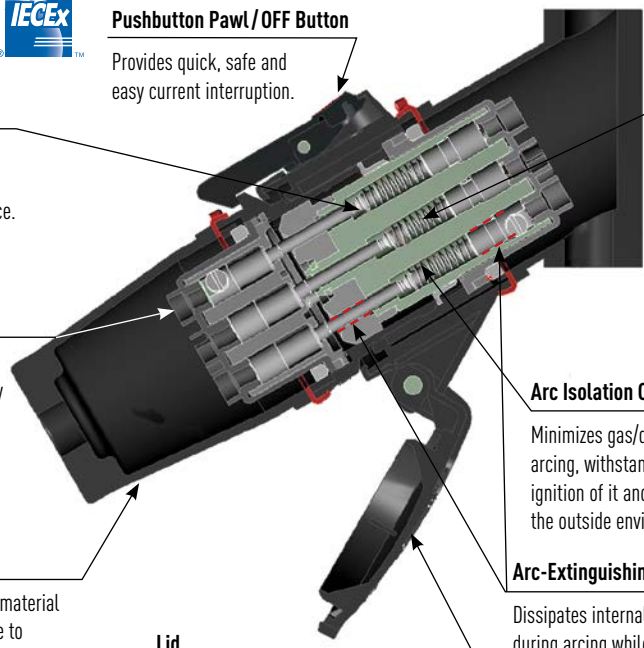

Operating Instructions



To connect, align the red dots, push the plug partially in, then turn clockwise slightly to line up the latch with the catch.



Push the plug fully home until it is held in place by the latch. The circuit is now closed.



To disconnect, depress the latch and pull the plug simultaneously. This breaks the circuit. The plug contacts are now dead.



Rotate 30° counterclockwise and then withdraw the plug. The safety shutter prevents access to live parts.

General Ratings

Amperage	20 to 60A
Voltage	600 VAC
Frequency	50-400 Hz
Horsepower	1/2 to 20 hp
Environmental	IP66/IP67
Temperature	min -40°F/max 140°F

* DXN30 and DXN60 devices are 550VAC if ordered with optional auxiliary contacts.

Hazardous Location Listings (CSA or ATEX)

CSA	ATEX
Ex de IIC T*Gb	II 2 G/D
Ex tb IIIC T*Db	Ex de IIC T*Gb
	Ex tb IIIC T*Db
Class I Zone I AEx de IIC T*Gb	
Zone 21 AEx tD T*Db	
Class I Division 2 Gr A,B,C,D	
Class II Division 2 Gr E,F,G	

* See temperature tables in product sections.
See following page for additional ratings detail.

Plug & Receptacle Listings (CSA or ATEX)

Category	CSA	IEC
Plugs and Receptacles	C22.2 No. 182.1	60309-1

CE ratings available upon request.

Highlighted Feature

Dead Front



The dead front on the DXN receptacle provides protection from accidental tool and wire insertion.

HAZARDOUS LOCATION

DXN Certifications

Hazardous Duty Certification (example)

DXN's are offered with CSA or ATEX certifications for use in hazardous locations.

CSA

$-40^{\circ}\text{C} \leq \text{Ta} \leq +60^{\circ}\text{C}$

Class I Zone 1 AEx de IIC T5, Gb

Zone 21, AEx tD T90°C Db

Class I Division 2 Gr A,B,C,D

Class I – Indicates suitability for use in applications where flammable Gases, Vapors, or Mists may be present.

Zone I – Indicates suitability for use in applications where an explosive environment is likely to occur in the air in sufficient quantities to produce explosive or ignitable mixtures under normal operating conditions.

Division 2 – Indicates suitability for use where exposure to the hazard occurs under abnormal conditions.

GR A,B,C,D – Indicates suitability for use in areas that may contain Acetylene, Hydrogen, Ethylene, or Propane.

Class II Division 2 Gr E,F,G

Class II – Indicates suitability for use in applications where explosive dust atmosphere may occur.

Division 2 – Indicates suitability for use where hazard exposure occurs under abnormal conditions.

GR E,F,G – Indicates suitability for use in areas where Magnesium, Coal or Grain dust may occur.



CSA certification based on IEC 60079-0, 60079-1, 60079-7

ATEX and IECEx

II 2 G/D Ex de IIC T* Gb

Ex tb IIIC T* Db

$-40^{\circ}\text{C} \leq \text{Ta} \leq +60^{\circ}\text{C T5 T90}^{\circ}\text{C}$

$-40^{\circ}\text{C} \leq \text{Ta} \leq +40^{\circ}\text{C T6 T70}^{\circ}\text{C}$



II – Indicates suitability for installation in surface applications (as opposed to underground mine applications).

2 – Indicates suitability for use where a high level of protection is required and where the presence of an explosive atmosphere is likely to occur occasionally during normal operation (Zone 1 and Zone 21 environments).

G/D – Indicates suitability for installation in areas that may contain flammable gases, vapors/mists, or dusts.

T90°C* – Indicates a maximum surface temperature of the product of 90°C, at -40°C to 60°C ambient.

Ex de – Indicates that explosion protection is provided with (e) increased safety in the conductor termination area, and (d) flame proof chambers for making and breaking the current that can withstand the pressure of internal ignition and that prevent arcs, flame or other ignition events from being communicated to the surrounding atmosphere.

IIC – Indicates suitability for installation in areas where exposure to any type of gas, including the most dangerous subdivision C gases may occur.

T6* – Temperature class – the maximum product surface temperature is 185°F (85°C) for ambient temperature of 104°F (40°).

ATEX certification was performed by LCIE.

* Temperature ratings vary depending on product and ambient temperature. See specific product section for temperature ratings.

Electrical Performance Testing

Model	Key Performance Tests Passed				Temperature Rise (max)	Dielectric Test
	Mechanical Endurance	Electrical Endurance ¹	Overload Testing ²			
DXN20	-	5000 Operations	50 Operations	30°C	2 x V (rated) + 1000V	
DXN30	1000 Cycles	1000 Operations	50 Operations	30°C	2 x V (rated) + 1000V	
DXN60	1000 Cycles	1000 Operations	50 Operations	30°C	2 x V (rated) + 1000V	

¹ @ 100% of rated current and voltage and 0.6 power factor

² @125% of rated current, 110% of rated voltage, & 0.6 power factor

DXN Operation

Arcing is a natural occurrence when electrical contacts make and break under load. The purpose of a hazardous duty product is to prevent arcing from igniting hazardous gases or dusts present in the atmosphere into an explosion that may cause personal injury or damage to facilities and equipment. The DXN accomplishes this with specially designed flame-proof arc chambers.

The arc chambers are sized to minimize the amount of atmospheric gas or air/dust mixture that may ignite during arcing and are built to contain this internal mini-explosion and withstand the pressure that it generates. The length and width of the flame-proof pathways are very precisely designed to provide for the effective dissipation of the pressure, while also ensuring that the arcing and internal ignitions of gases or air/dust mixture in the arc chamber are totally isolated from the surrounding atmosphere.

1 When the plug and receptacle are connected, the flameproof arc chamber is completed with pressure relief/arc extinguishing pathways between the outer diameter of the plug contact and its associated contact hole in the safety shutter and between the main interior component and receptacle contact base.

2 DXN's are current interrupting rated devices. They can safely make and break under full load and also during moderate overload situations. During the making or breaking of the contacts, the arc chamber completely contains any ignitions of gas or dust due to arcing and the flame-proof pathways dissipate the pressure.

3 As the plug is being inserted or removed, the flame-proof arc chamber and pathways are maintained. This ensures continuous hazardous duty protection and the safety of the user.

4 When the plug and receptacle are disconnected, the receptacle maintains a flame-proof chamber. In this case, the flame-proof pathway exists between the safety shutter and the main interior component. The shutter also prevents access to live parts, providing users with the safety of a dead front. The plug must be inserted into the safety shutter and be rotated in order to access the receptacle contacts.

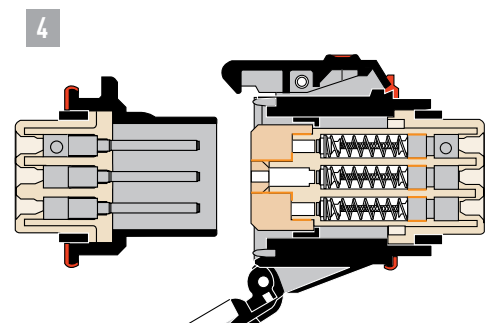
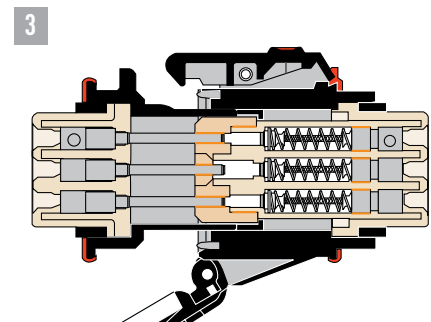
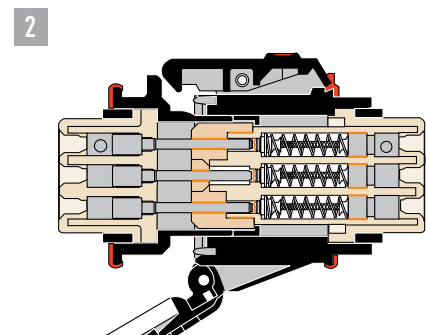
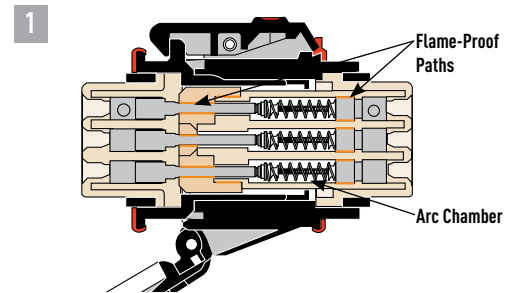

DXN20 Hazardous Location Plugs & Receptacles – 20A

Devices rated for hazardous locations are not returnable.

cCSAus Certifications DXN20

- Max Amperage & Voltage**
20A, 600 VAC, 60 Hz
- Current Interruption Capability**
For current interrupting (AC)
- Horsepower Ratings**

120V	1Ø	1/2 hp
240V	3Ø	2 hp
480V	3Ø	5 hp
600V	3Ø	5 hp
- Short Circuit Rating**
25kA Close & Withstand
Testing was performed with RK1 30A fuse sized at 400% of the highest full load motor ampacity associated with the devices hp rating.
Note: Consult NEC for Short Circuit limits.
- Environmental Ratings**
Type IP66/IP67
- Wiring Capacity**
Min 16 AWG Max 10 AWG
* Based on THHN wire sizes
- Applicable Standards**
CSA C22.2 No. 182.1
- Hazardous Location Ratings**

-40°C ≤ Ta ≤ +60°C
Ex de IIC T5 Gb Ex tb IIIC T90°C Db
Class I Zone 1 AEx de IIC T5 Gb
Zone 21 AEx td T90°C Db
Class I Div 2 Gr A, B, C, D
Class II Div 2 Gr E, F, G
cCSAus 00.1144.106X

Receptacle (female)



Standard DXN20 lid opens to 120°

Inlet (male)



! Receptacles & Inlets must be mounted to a DXN handle, angle or wall box

North American cCSAus Configurations

Voltage	Polarity	Part # Poly	Part # Poly
120V	1P+N+G	22-14165	22-18165
125V	1P+N+G	22-14075	22-18075
208V	2P+G	22-14162	22-18162
208V	3P+G	22-14163	22-18163
208V	3P+N+G	22-14167	22-18167
250V	2P+G	22-14072	22-18072
250V	3P+G	22-14073	22-18073
250V	2P+N+G	22-14076	22-18076
277V	1P+N+G	22-14045	22-18045
480V	2P+G	22-14042	22-18042
480V	3P+G	22-14043	22-18043
480V	3P+N+G	22-14047	22-18047
600V	2P+G	22-14142	22-18142
600V	3P+G	22-14143	22-18143
600V	3P+N+G	22-14147	22-18147

Receptacle Options	Suffix #	Inlet Options	Suffix #
Padlock Pawl	Recept # - 843	With No Lockout Hole	Inlet # - A155
Metal Pawl on Poly Receptacle	Recept # - 924		
Closed Lid Configuration	Recept # - R		
180° Lid Opening	Recept # - 180		

ATEX/IECEx Certifications DXN1

- Current** 20A
- Environmental** IP66/IP67
- Ambient Temp** -40°C to +60°C
- Hazardous Location Ratings**
ATEX/IECEx Zones 1 & 2, 21 & 22

MARECHAL ELECTRIC MAROMME
Ex II 2 G/D Ex de IIC T*Gb
Ex tb IIIC T*Db

-40 °C ≤ Ta ≤ +60 °C T5 T90 °C
-40 °C ≤ Ta ≤ +40 °C T6 T70 °C
IECEx LCI 09.0005X / LCIE 99 ATEX 6027X

See MELTRIC's International Catalog (online) for additional product information.

Receptacle

Inlet

IEC/CE Configurations (ATEX/IECEx)

Voltage	Polarity	Part # Poly	Part # Poly
20 - 24 V	2P	25-1408A	25-1808A
190 - 230 V	3P+E	25-14033	25-18033
220 - 250 V	1P+N+E	25-14015	25-18015
380 - 440 V	3P+E	25-14013	25-18013
380 - 440 V	3P+N+E	25-14017	25-18017
480 - 500 V	3P+E	25-14093	25-18093
480 - 500 V	3P+N+E	25-14097	25-18097

Receptacle Options	Suffix #	Receptacle Options	Suffix #
Padlock Pawl w/shaft for 3 locks	Recept # + 844	Self-returning Lid	Recept # + R
180° Lid Opening	Recept # + 10	180° Opening & Self-returning Lid	Recept # + 18

INSTALLATION ACCESSORIES – SIZE 1

Accessories rated for hazardous locations are not returnable.

HANDLES

POLY HANDLE w/NPT		Part #	
	1/2"	22-1A013-12	For use in Class I or II Division 2 or Class 1 Zone 1 or Zone 21 depending on fitting used. Fitting manufactured by others.
	3/4"	22-1A013-34	

POLY HANDLE w/CORD GRIP w/Cable Range			
	.24 - .47"	251P0BPA	For use in Class I or II Division 2, Class I Zone 1 or Zone 21 -20°C ≤ Ta ≤ +85°C
	.39 - .55"	251P0BPB	
	.35 - .63"	251P0CPD	
	.51 - .71"	251P0CPC	

ANGLES

POLY ANGLE			
	30°	22-1A057	

HANDLES

POLY HANDLE w/POLY Cable Gland		Part #	
	7 - 14 mm	25-1A753	For use in Zones 1 & 2 Zones 21 & 22
	10 - 18 mm	25-1A253-25P	
	17 - 24 mm	25-1A253-32P	

POLY HANDLE w/METAL Cable Gland			
	8 - 10 mm	25-1A253-20M	With Earth continuity
	12 - 14 mm	25-1A253-25M	
	18 - 24 mm	25-1A253-32M	

ANGLES

POLY ANGLE			
	30°	25-1A057	

POLY ANGLE			
	70°	25-1A757	For panel mounting. Not a replacement part for 70° wall box.

BOXES

POLY WALL BOX w/NPT			Part #	
	30°	1/2"	22-1A023-12-T	NPT Thread on top
	30°	3/4"	22-1A023-34-T	* Interior volume with receptacle installed.

POLY WALL BOX w/NPT			Part #	
	30°	1/2"	22-1A023-12-B	NPT Thread on bottom
	30°	3/4"	22-1A023-34-B	* Interior volume with receptacle installed.

POLY ANGLE WITH LARGER METAL WALL BOX w/NPT			Part #	
	70°	1/2"	22-1A058-12	NPT is drilled on top of metal box as standard. For NPT on side only, add an "L" suffix. To switch from top to bottom or left to right the box can be rotated.
	70°	3/4"	22-1A058-34	
	70°	1"	22-1A058-1	
	70°	1 1/4"	22-1A058-114	
	70°	1 1/2"	22-1A058-112	

NPT on top or bottom (if rotated). For other NPT configurations, contact customer service. * Interior volume with receptacle installed.

MISCELLANEOUS ACCESSORIES

FINGER DRAWPLATES			
	61-1A346	Set of Two (2)	Recommended for cord to cord assembly applications, for easier connector closure.

PROTECTIVE CAP			
	22-1A426	For Male Devices Only.	

RECEPTACLE LOCKING PIN			
	LP-843	Requires Padlockable Pawl option (-843) on receptacle.	

BOXES

POLY WALL BOX			Part #	
	30°	7 - 14 mm	25-1AB53	
	30°	10 - 18 mm	25-1AB53-25P	

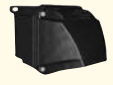
POLY WALL BOX 120x120 w/o TERMINAL BLOCKS			Part #	
	70°	7 - 14 mm	25-1AB88-20P	With earth continuity + 1 hole with a poly cable gland.
	70°	10 - 18 mm	25-1AB88-25P	
	70°	17 - 24 mm	25-1AB88-32P	

POLY WALL BOX 120x120 w/4mm² TERMINAL BLOCKS			Part #	
	70°	7 - 14 mm	25-1A088-20P	With 2 holes (1 with a cable gland + 1 with a stopping plug), with 8+2E 4 mm² terminals blocks + 2,5 mm² wires, wiring 2,5-4 mm². For loop in loop out wiring.
	70°	10 - 18 mm	25-1A088-25P	

New 70° angle will replace the 30° angle (shown) on poly wall box in 2018. -40°C ≤ Ta ≤ +60°C T5 T90°C -40°C ≤ Ta ≤ +40°C T6 T70°C

HAZARDOUS
LOCATION

DXN30 Hazardous Location Plugs & Receptacles – 30A

Devices rated for hazardous locations are not returnable.

cCSAus Certifications DXN30

- Max Amperage & Voltage**
30A, 600 VAC, 60 Hz
- Current Interruption Capability**
For current interrupting (AC)
- Horsepower Ratings**

120V	1Ø	1 hp
240V	3Ø	5 hp
480V	3Ø	10 hp
600V	3Ø	15 hp
- Short Circuit Rating**
25kA Close & Withstand
Testing was performed with RK1 70A fuse sized at 400% of the highest full load motor ampacity associated with the devices hp rating.
Note: Consult NEC for Short Circuit limits.
- Environmental Ratings**
Type IP66/IP67
- Wiring Capacity**
Min 14 AWG Max 6 AWG
Aux Contacts - Max 10 AWG
- * Based on THHN wire sizes
- Applicable Standards**
CSA C22.2 No. 182.1
- Hazardous Location Ratings**

-40°C ≤ T_a ≤ +60°C
Ex de IIC T5 Gb Ex tb IIIC T77°C Db
Class I Zone 1 AEx de IIC T5 Gb
Zone 21 AEx td T77°C Db
Class II Div 2 Gr A, B, C, D
Class II Div 2 Gr E, F, G
cCSAus 00.1144106X

Receptacle (female)



Standard DXN30 lid opens to 120°

Inlet (male)



! Receptacles & Inlets must be mounted to a DXN handle, angle or wall box

North American cCSAus Configurations

Voltage	Polarity	Part # Poly	Part # Poly
120V	1P+N+G	22-34165	22-38165
125V	1P+N+G	22-34075	22-38075
208V	2P+G	22-34162	22-38162
208V	3P+G	22-34163	22-38163
208V	3P+N+G	22-34167	22-38167
250V	2P+G	22-34072	22-38072
250V	3P+G	22-34073	22-38073
250V	2P+N+G	22-34076	22-38076
277V	1P+N+G	22-34045	22-38045
480V	2P+G	22-34042	22-38042
480V	3P+G	22-34043	22-38043
480V	3P+N+G	22-34047	22-38047
600V	2P+G	22-34142	22-38142
600V	3P+G	22-34143	22-38143
600V	3P+N+G	22-34147	22-38147

Receptacle Options	Suffix #	Inlet Options	Suffix #
With 2 Auxiliary/Pilot Contacts*	Recept # - 972	With 2 Auxiliary/Pilot Contacts*	Inlet # - 972
Padlock Pawl	Recept # - 843	With No Lockout Hole	Inlet # - A155
Metal Pawl on Poly Receptacle	Recept # - 924	* Not available with 600V devices, use -972-S74 for 550 VAC	
Closed Lid Configuration	Recept # - R		
180° Lid Opening	Recept # - 180		

ATEX/IECEx Certifications DXN30

- Current** 32A
- Environmental** IP66/IP67
- Ambient Temp** -40°C to +60°C
- Hazardous Location Ratings**
ATEX/IECEx Zones 1 & 2, 21 & 22

MARECHAL ELECTRIC MAROMME
Ex de IIC T*Gb
Ex tb IIIC T*Db
-40 °C ≤ T_a ≤ +60 °C T5 T77 °C
-40 °C ≤ T_a ≤ +40 °C T6 T57 °C
IECEx LCI 09.0006X / LCIE 05 ATEX 6149

See MELTRIC's International Catalog (online) for additional product information.

Receptacle

Inlet

IEC/CE Configurations (ATEX/IECEx)

Voltage	Polarity	Part # Poly	Part # Poly
20 - 24 V	2P	25-3408A	25-3808A
190 - 230 V	3P+E	25-34033	25-38033
220 - 250 V	1P+N+E	25-34015	25-38015
380 - 440 V	3P+E	25-34013	25-38013
380 - 440 V	3P+N+E	25-34017	25-38017
480 - 500 V	3P+E	25-34093	25-38093
480 - 500 V	3P+N+E	25-34097	25-38097

Receptacle Options	Suffix #	Receptacle Options	Suffix #
Padlock Pawl w/shaft for 3 locks	Recept # + 844	Self-returning Lid	Recept # + R
180° Lid Opening	Recept # + 10	180° Opening & Self-returning Lid	Recept # + 18
With 2 Auxiliary/Pilot Contacts*	Recept # + 972 Inlet # + 972		

INSTALLATION ACCESSORIES – SIZE 2

Accessories rated for hazardous locations are not returnable.

HANDLES

POLY HANDLE w/NPT		Part #	
	3/4"	22-3A013-34	For use in Class I or II Division 2 or Class 1 Zone 1 or Zone 21 depending on fitting used. Fitting manufactured by others.
	1"	22-3A013-1	

POLY HANDLE w/CORD GRIP w/Cable Range			
	.35 - .63"	252P0CPD	For use in Class I or II Division 2, Class I Zone 1 or Zone 21. -20°C ≤ Ta ≤ +85°C
	.51 - .71"	252P0CPC	
	.51 - .79"	252P0DPF	
	.71 - .98"	252P0DPE	

ANGLES

POLY ANGLE			
	30°	22-3A027	

HANDLES

POLY HANDLE w/POLY Cable Gland		Part #	
	7 - 14 mm	25-3A753	For use in Zones 1 & 2 Zones 21 & 22
	10 - 18 mm	25-3A783	
	17 - 24 mm	25-3A253-32P	
	17 - 31 mm	25-3A253-40P	

POLY HANDLE w/METAL Cable Gland			
	8 - 10 mm	25-3A253-20M	With Earth continuity
	12 - 14 mm	25-3A253-25M	
	18 - 24 mm	25-3A253-32M	

ANGLES

POLY ANGLE			
	30°	25-3A027	

POLY ANGLE			
	70°	25-3A757	For panel mounting. Not a replacement part for 70° wall box.

BOXES

POLY WALL BOX w/NPT		Part #	
	30° 3/4"	22-3A023-34-T	NPT Thread on top. * Interior volume with receptacle installed.

POLY WALL BOX w/NPT		Part #	
	30° 3/4"	22-3A023-34-B	NPT Thread on bottom. * Interior volume with receptacle installed.

POLY ANGLE WITH LARGER METAL WALL BOX w/NPT			
	70° 1/2"	22-3A058-12	NPT is drilled on top of metal box as standard. For NPT on side only, add an "L" suffix. To switch from top to bottom or left to right the box can be rotated. * Interior volume with receptacle installed.
	70° 3/4"	22-3A058-34	
	70° 1"	22-3A058-1	
	70° 1 1/4"	22-3A058-114	
	70° 1 1/2"	22-3A058-112	

NPT on top or bottom (if rotated). For other NPT configurations, contact customer service.

MISCELLANEOUS ACCESSORIES

FINGER DRAWPLATES			
	61-3A346	Set of Two (2)	Recommended for cord to cord assembly applications, for easier connector closure.

PROTECTIVE CAP			
	22-3A426	For Male Devices Only.	

RECEPTACLE LOCKING PIN			
	LP-843	Requires Padlockable Pawl option (-843) on receptacle.	

BOXES

POLY WALL BOX		Part #	
	30° 7 - 14 mm	25-3AB53	
	30° 10 - 18 mm	25-3AB53-25P	

POLY WALL BOX 160x160 w/o TERMINAL BLOCKS			
	70° 7 - 14 mm	25-3AB88-20P	With earth continuity + 1 hole with a poly cable gland.
	70° 10 - 18 mm	25-3AB88-25P	
	70° 17 - 24 mm	25-3AB88-32P	

POLY WALL BOX 160x160 w/10mm ² TERMINAL BLOCKS			
	70° 7 - 14 mm	25-3A088-20P	With 2 holes (1 with a cable gland + 1 with a stopping plug), with 8+2E 10 mm ² terminals blocks + 6 mm ² wires, wiring 6-10 mm ² . For loop in loop out wiring. -40°C ≤ Ta ≤ +60°C T5 T77°C -40°C ≤ Ta ≤ +40°C T6 T57°C
	70° 10 - 18 mm	25-3A088-25P	
	70° 17 - 24 mm	25-3A088-32P	

New 70° angle will replace the 30° angle (shown) on poly wall box in 2018.

DXN60 Hazardous Location Plugs & Receptacles – 60A

Devices rated for hazardous locations are not returnable.

cCSAus Certifications DXN60

- Max Amperage & Voltage**
60A, 600 VAC, 60 Hz
- Current Interruption Capability**
For current interrupting (AC)
- Horsepower Ratings**

120V	1Ø	2 hp
240V	3Ø	7.5 hp
480V	3Ø	20 hp
600V	3Ø	20 hp
- Short Circuit Rating**
25kA Close & Withstand
Testing was performed with RK1 100A fuse sized at 400% of the highest full load motor ampacity associated with the devices hp rating.
Note: Consult NEC for Short Circuit limits.
- Environmental Ratings**
Type IP66/IP67
- Wiring Capacity**
Min 10 AWG Max 4 AWG
Aux Contacts - Max 10 AWG
* Based on THHN wire sizes
- Applicable Standards**
CSA C22.2 No. 182.1
- Hazardous Location Ratings**

-40°C ≤ Ta ≤ +60°C
Ex de IIC T4 Gb Ex tb IIIC T100°C Db
Class I Zone 1 AEx de IIC T4 Gb
Zone 21 AEx td T100°C Db
Class I Div 2 Gr A,B,C,D
Class II Div 2 Gr E,F,G
cCSAus 00.1144106X

Receptacle (female)



Standard DXN60 lid opens to 120°

Inlet (male)



! Receptacles & Inlets must be mounted to a DXN handle, angle or wall box

North American cCSAus Configurations

Voltage	Polarity	Part # Poly	Part # Poly
120V	1P+N+G	22-64165	22-68165
125V	1P+N+G	22-64075	22-68075
208V	2P+G	22-64162	22-68162
208V	3P+G	22-64163	22-68163
208V	3P+N+G	22-64167	22-68167
250V	2P+G	22-64072	22-68072
250V	3P+G	22-64073	22-68073
250V	2P+N+G	22-64076	22-68076
277V	1P+N+G	22-64045	22-68045
480V	2P+G	22-64042	22-68042
480V	3P+G	22-64043	22-68043
480V	3P+N+G	22-64047	22-68047
600V	2P+G	22-64142	22-68142
600V	3P+G	22-64143	22-68143
600V	3P+N+G	22-64147	22-68147

Receptacle Options	Suffix #	Inlet Options	Suffix #
With 2 Auxiliary/Pilot Contacts*	Recept # - 972	With 2 Auxiliary/Pilot Contacts*	Inlet # - 972
Padlock Pawl	Recept # - 843	With No Lockout Hole	Inlet # - A155
Metal Pawl on Poly Receptacle	Recept # - 924	* Not available with 600V devices, use -972-S74 for 550 VAC	
Closed Lid Configuration	Recept # - R		
180° Lid Opening	Recept # - 180		

ATEX/IECEX Certifications DXN6

- Current** 63A
- Environmental** IP66/IP67
- Ambient Temp** -40°C to +60°C
- Hazardous Location Ratings**
ATEX/IECEX Zones 1 & 2, 21 & 22

MARECHAL ELECTRIC MAROMME
Ex IIC G/D Ex de IIC T*Gb
Ex tb IIIC T*Db
-40 °C ≤ Ta ≤ +60 °C T4 T107 °C
-40 °C ≤ Ta ≤ +40 °C T5 T87 °C
IECEX LCI 09.0007 / LCIE 05 ATEX 6150

See MELTRIC's International Catalog (online) for additional product information.

Receptacle

Inlet

IEC/CE Configurations (ATEX/IECEX)

Voltage	Polarity	Part # Poly	Part # Poly
20 - 24 V	2P	25-6408A	25-6808A
190 - 230 V	3P+E	25-64033	25-68033
220 - 250 V	1P+N+E	25-64015	25-68015
380 - 440 V	3P+E	25-64013	25-68013
380 - 440 V	3P+N+E	25-64017	25-68017
480 - 500 V	3P+E	25-64093	25-68093
480 - 500 V	3P+N+E	25-64097	25-68097

Receptacle Options	Suffix #	Receptacle Options	Suffix #
Padlock Pawl w/shaft for 3 locks	Recept # + 844	Self-returning Lid	Recept # + R
180° Lid Opening	Recept # + 10	180° Opening & Self-returning Lid	Recept # + 18
With 2 Auxiliary/Pilot Contacts*	Recept # + 972 Inlet # + 972		

INSTALLATION ACCESSORIES – SIZE 3

Accessories rated for hazardous locations are not returnable.

HANDLES

POLY HANDLE w/NPT		Part #	
	1"	22-6A013-1	For use in Class I or II Division 2 or Class 1 Zone 1 or Zone 21 depending on fitting used. Fitting manufactured by others.

POLY HANDLE w/CORD GRIP w/Cable Range			
	.51 - .79"	253P0DPF	For use in Class I or II Division 2, Class I Zone I or Zone 21.
	.71 - .98"	253P0DPE	

-20°C ≤ Ta ≤ +85°C

ANGLES

POLY ANGLE			
	30°	22-6A027	

BOXES

POLY WALL BOX w/NPT		Part #	
	30° 1"	22-6A023-1-T	NPT Thread on top. * Interior volume with receptacle installed.

POLY WALL BOX w/NPT		Part #	
	30° 1"	22-6A023-1-B	NPT Thread on bottom. * Interior volume with receptacle installed.

POLY ANGLE WITH LARGER METAL WALL BOX w/NPT			
	70° 1/2"	22-6A058-12	NPT is drilled on top of metal box as standard. For NPT on side only, add an "L" suffix. To switch from top to bottom or left to right the box can be rotated. * Interior volume with receptacle installed.
	70° 3/4"	22-6A058-34	
	70° 1"	22-6A058-1	
	70° 1 1/4"	22-6A058-114	
	70° 1 1/2"	22-6A058-112	

NPT on top or bottom (if rotated). For other NPT configurations, contact customer service.

MISCELLANEOUS ACCESSORIES

FINGER DRAWPLATES			
	61-6A346	Set of Two (2)	Recommended for cord to cord assembly applications, for easier connector closure.

PROTECTIVE CAP			
	22-6A426	For Male Devices Only.	

RECEPTACLE LOCKING PIN			
	LP-843	Requires Padlockable Pawl option (-843) on receptacle.	

HANDLES

POLY HANDLE w/POLY Cable Gland		Part #	
	7 - 14 mm	25-6A253-20P	For use in Zones 1 & 2 Zones 21 & 22.
	10 - 18 mm	25-6A753	
	17 - 24 mm	25-6A253-32P	
	17 - 31 mm	25-6A253-40P	

POLY HANDLE w/METAL Cable Gland			
	8 - 10 mm	25-6A253-20M	With Earth continuity.
	12 - 14 mm	25-6A253-25M	
	18 - 24 mm	25-6A253-32M	

ANGLES

POLY ANGLE			
	30°	25-6A027	

POLY ANGLE			
	70°	25-6A757	For panel mounting. Not a replacement part for 70° wall box.

BOXES

POLY WALL BOX		Ex Cable Gland	Part #
	30°	M25	25-6AB53

POLY WALL BOX 160x160 w/o TERMINAL BLOCKS			
	70°	7 - 14 mm	25-6AB88-20P
	70°	10 - 18 mm	25-6AB88-25P
	70°	17 - 24 mm	25-6AB88-32P
	70°	17 - 31 mm	25-6AB88-40P

POLY WALL BOX 160x160 w/16mm ² TERMINAL BLOCKS			
	70°	7 - 14 mm	25-6A088-20P
	70°	10 - 18 mm	25-6A088-25P
	70°	17 - 24 mm	25-6A088-32P
	70°	17 - 31 mm	25-6A088-40P

New 70° angle will replace the 30° angle (shown) on poly wall box in 2018.

With earth continuity + 1 hole with a poly cable gland.

With 2 holes (1 w/ cable gland + 1 w/ stopping plug), with 8×2E 16 mm² terminals blocks + 16 mm² wires, wiring 16 mm². For loop in loop out wiring.

-40°C ≤ Ta ≤ +55°C T4/T105°C
-40°C ≤ Ta ≤ +50°C T5/T95°C