



2018 PRODUCT CATALOG

INDUSTRIAL PLUGS & RECEPTACLES

- SWITCH-RATED PLUGS & RECEPTACLES
- HAZARDOUS LOCATION PLUGS & RECEPTACLES
- CUSTOM POWER DISTRIBUTION PANELS
- HIGH AMPERAGE CONNECTORS
- MULTIPIN CONNECTORS



Introduction

MELTRIC Overview	pg 2
Product Features & Benefits	pg 4
Product Summary & Selection Guide	pg 8
Part Number & Ordering Guide	pg 14
Switch-Rated Plugs & Receptacles	
The Main Differences	pg 16
Selection Guide	pg 20
DSN Type 4X/IP69k rated, metal or poly casings. From 20 – 150A (1/2 – 75 hp)	pg 22
DS Type 3R rated, metal or poly casings. From 20 – 200A (3/4 – 100 hp)	pg 38
DB IP67 rated, metal casings. From 30 – 100A (2 – 60 hp)	pg 56

Multipin Plugs & Receptacles

Multipin 4 – 37 pin connectors in poly and metal. From 2 – 150A	pg 70
--	-------

Standard Duty Plugs & Receptacles

DR Type 3R rated, poly or metal casings. From 30 – 400A	pg 96
PN IP66/IP67 rated or IP54 rated, poly or metal. 20A	pg 114
High Temp For environments up to 465°F (240°C)	pg 122

Direct Current Plugs & Receptacles

DSDC DC current rated, poly or metal casings. Up to 750 VDC	pg 126
--	--------

High Ampacity Plugs & Receptacles

PF/PFQ IP66/IP67 rated, metal construction. From 300 – 600A	pg 132
DR400 Type 3R rated, metal casings. 400A	pg 140
SP Single pole, connectors up to 600A	pg 144
CS1000 Single pole, connectors up to 400A	pg 148

Power Distribution

Custom Power Distribution Solutions Built specifically to meet customer needs	pg 154
Integral Circuit Protection Wall Boxes Premounted receptacles wired to circuit protection 20-60A	pg 162
GFCI Combinations Premounted receptacles wired to GFCI boxes 20-60A	pg 168
Safety Switch/Receptacle Combinations Switch-rated receptacles mounted to single throw, fusible safety switch	pg 170

Specialty Products

WS – Welding Connectors Single pole connectors (max 50 VAC)	pg 174
Adapter Plates For converting existing receptacles to MELTRIC	pg 175
Cord Grips	pg 178
Voltage/Phase Rotation Meter Assemblies	pg 180

Hazardous Location Plugs & Receptacles

Hazardous Duty Selection Guide	pg 184
DXN Hazardous rated, poly casings. From 20 – 60A (1/4 – 20 hp)	pg 186
DXA Hazardous rated, metallic casings. From 20 – 100A	pg 198
DSN/DS/DR/DSDC Hazardous rated, metallic casings. 2 – 250A (up to 100 hp)	pg 202
DX Hazardous rated, metallic casings. From 20 – 125A	pg 226
Multipin Hazardous rated, 12 to 37 pins, 10A	pg 236
SPeX Hazardous rated, up to 680A, 1000VAC	pg 242

MELTRIC Corporation

The best in industrial wiring devices



At MELTRIC Corporation, our only business is electrical plugs and receptacles. We are focused on providing our customers with the best overall value by offering the safest, highest quality and most reliable plugs and receptacles, and by backing them with outstanding service and support.

Product Technology & Safety

The technology behind MELTRIC's products was developed specifically to address the shortcomings and safety hazards common with pin & sleeve type plugs and receptacles. In 1952, following the observation of an accident with a pin and sleeve device, Gilles Marechal devised the concept of combining the advantages of silver-nickel butt contacts and the load making and breaking capabilities of a switch with the convenience of a plug and receptacle. Shortly thereafter, the first of these products was born. MELTRIC licensed this technology in the early 1980's and has been supplying its products to North American customers ever since.

Value

With their unique features and capabilities, MELTRIC products provide users with a safer and more reliable product than competitive pin and sleeve devices. MELTRIC's butt-style contacts provide longer operating lives, optional integral pilot contacts reduce the need for additional connectors and our switch-rated plugs and receptacles can eliminate the need for auxiliary interlocks and disconnect switches, helping users reduce equipment costs. These advantages, together with competitive pricing, short lead times, and 5-year warranty on electrical contacts, make MELTRIC's products the best overall value in the plug & receptacle/connector market.

Service & Support

MELTRIC backs its superior products with outstanding service and support. A network of over 150 sales associates and over 2000 distributor locations throughout the US, Canada and Mexico make access to our product easy.

MELTRIC's Customer Service group is trained to answer most questions on the spot and is located at our manufacturing facility in order to help streamline the order fulfillment process. Our engineering team stands ready to provide both application support and custom designed products incorporating MELTRIC and third party components into power distribution products tailored to meet your needs. Friendly and personal assistance is only a toll free call away at (800) 433-7642.

Many of MELTRIC's products are designed in a modular fashion, which permits cost effective stocking of components and quick final assembly of the product. Together with efficient order handling by Customer Service, this helps MELTRIC to provide the shortest lead times in the industry.

Quality

Quality is not just an inspection function at MELTRIC. Quality starts with intelligent designs, robust materials, clear procedures, process measurement and controls and effective communications. It is completed by the care, commitment and involvement of each of our employees.

MELTRIC is dedicated to the continuous improvement of all its critical production and support processes and is ISO 9001:2015 certified. MELTRIC designs and manufactures its products to exceed the requirements of applicable UL, CSA and IEC standards.



Worldwide Availability

Marechal Technology products are manufactured in North America, Europe, South Africa and Australia. MELTRIC supplies product directly from its factory in Franklin, Wisconsin to customers in the United States, Canada and Mexico. For customers outside of North America, product is provided through other Marechal Electric Group companies and sales agents.

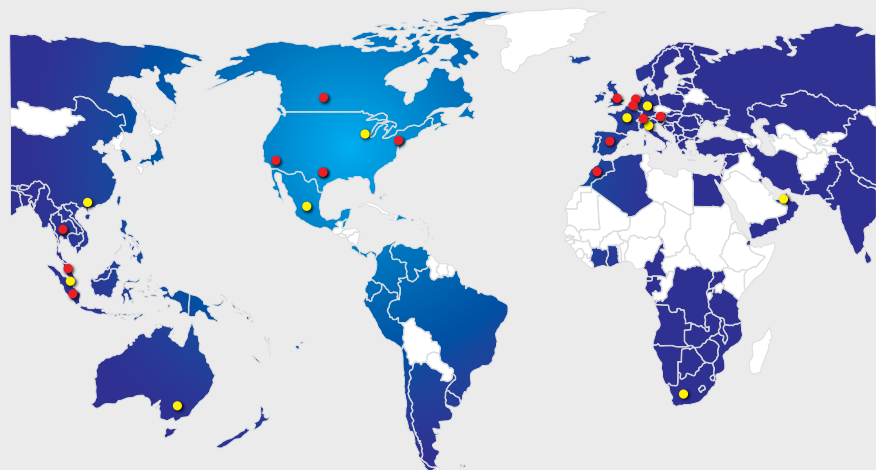

- SALES OFFICES & MANUFACTURING PLANTS
- COMPANY SALES PRESENCE
- SALES AGENTS & DISTRIBUTORS



MELTRIC PRODUCT FEATURES...



Spring-Loaded Butt Contacts

MELTRIC products feature spring-loaded, butt contacts similar to those used in contactors and switchgear. These contacts have numerous advantages, which help improve electrical performance and user safety relative to pin and sleeve contacts or the arcuate contacts used in twist-type devices.

Butt-style contacts ensure a very positive and consistent connection. The spring-loading of these contacts, which is accomplished with coil springs, provides a desirably high contact force that remains constant over thousands of operations. In addition, it automatically compensates for any wear and/or deviations in contact length resulting from manufacturing tolerances.

This is a critical point, as contact force is a key determinant of the quality of a contact. As the accompanying chart demonstrates, contact resistance increases as contact force is reduced. Higher contact resistance generates more heat

and oxidation, both of which contribute to the deterioration of the contact. This is a problem with pin and sleeve and arcuate type contacts because their contact force varies with manufacturing tolerances and is reduced due to wear that occurs with normal use.

Most MELTRIC contacts close with a self-cleaning wiping action. When the contacts initially mate, they are slightly offset. In completing the connection, the plug contacts are rotated across the receptacle contacts, helping to remove deposits from the contact surfaces.

In conjunction with the spring-loaded casings used on many MELTRIC products, the spring-loaded contacts ensure a quick breaking of the connection that is independent of the motion of the user. By contrast, the disconnection speed of pin and sleeve and twist-type devices is dependent upon the motion of the user.

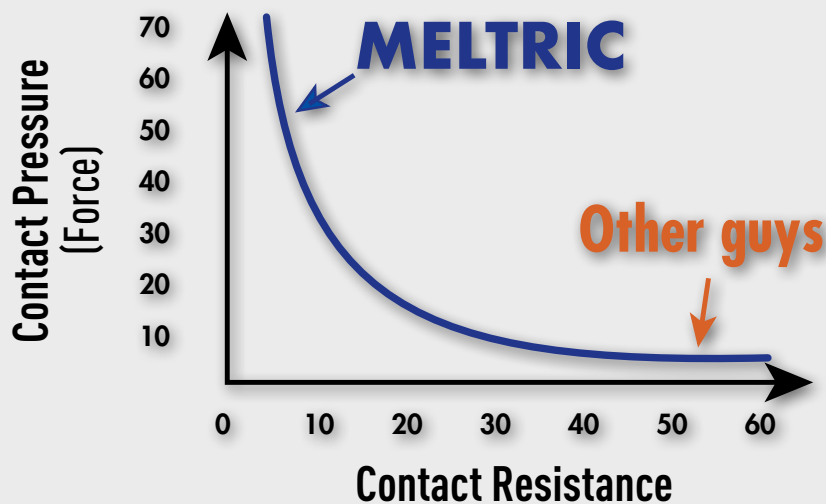

...AND BENEFITS

Silver-Nickel Contact Material

MELTRIC uses solid silver-nickel (85%/15%) contacts. The silver-nickel material has significant advantages over the brass contacts commonly used on competitive devices.

Silver has very low initial contact resistance and is not negatively affected by oxidation. This helps to give it excellent electrical properties that are maintained even at high temperatures and after tarnishing. Nickel is a much harder material and contributes excellent mechanical properties. The combination of silver and nickel results in a contact material that has both superior electrical capabilities and excellent resistance to wear. Silver-nickel only welds at extremely high pressure and temperature, and thus, also withstands arcs very well. These features make silver-nickel a commonly used contact material by switchgear manufacturers.

By contrast, the brass material used in most competitive plug and receptacles has much higher initial contact resistance and is negatively affected by oxidation. In an oxidized state, the contact resistance of brass is more than 20 times higher than that of silver-nickel. In addition, brass is a soft material that wears rapidly. In use, brass pin and sleeve and arcuate contacts suffer from the combined effects of the limitations of the material and the design. As oxidation and wear induced reductions in contact force occur, contact resistance increases. This increases operating temperature, which causes further oxidation and wear, perpetuating a vicious cycle of degradation. Brass is not arc resistant and is not suitable for making and breaking under load.

Dead Front Construction

Most MELTRIC products feature dead front construction, which greatly enhances safety by eliminating any unintended access to live parts. On most MELTRIC products, the dead front is accomplished with a safety shutter that can be opened only by an appropriate mating plug. The live receptacle contacts can only be accessed by the plug, after its insertion into the receptacle. The design of the product also ensures that the plug contacts are dead before the user can remove the plug from the receptacle.

By contrast, pin and sleeve and twist-type devices do not have a safety shutter. Access to live receptacle contacts is possible, and on some devices the plug contacts may be live and accessible when the plug is being removed.



MATERIAL	CONTACT		RESISTANCE
	NEW	OXIDIZED	
SILVER	6 $\mu\Omega$	25 $\mu\Omega$	
SILVER-NICKEL	23 $\mu\Omega$	60 $\mu\Omega$	
COPPER	29 $\mu\Omega$	400 $\mu\Omega$	
BRASS	370 $\mu\Omega$	1400 $\mu\Omega$	



MELTRIC PRODUCT FEATURES...

Push-Button Circuit Disconnection

To disconnect most MELTRIC products, the user simply needs to depress the pawl. This causes the circuit to be disconnected and the plug to be ejected to its rest (off) position in the receptacle. If desired, the user can then remove the plug from the receptacle by rotating it slightly and then withdrawing it. This mode of operation ensures that it is only possible to remove the plug after its contacts have been deenergized.



Enclosed Arc Chambers

The contacts on most MELTRIC products make and break within enclosed arc chambers. This ensures that the arcing which normally occurs during the making and breaking of the contacts is contained inside the device. This greatly enhances safety and avoids potential injury to users and/or harm to the outside environment.

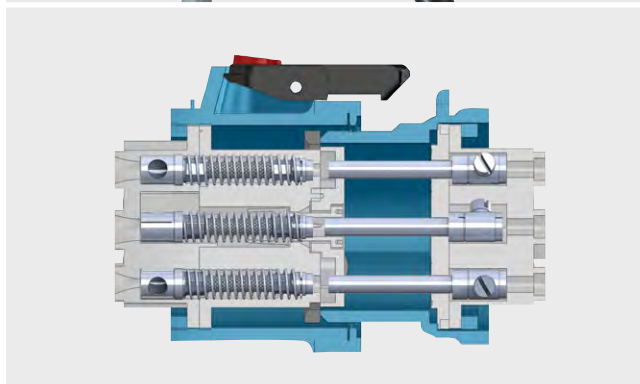

Optional Auxiliary/Pilot Contacts

Many MELTRIC products are available with optional auxiliary/pilot contacts. These integral pilot contacts allow users the convenience and flexibility of controlling auxiliary equipment, monitoring parameters (such as motor temperature), and/or communicating alarms through the same plug and receptacle used to supply power to the equipment. Because the pilot contacts are integral, they also facilitate the rapid change-out or reconfiguration of equipment by eliminating the need for hard wiring or multiple plug connections.

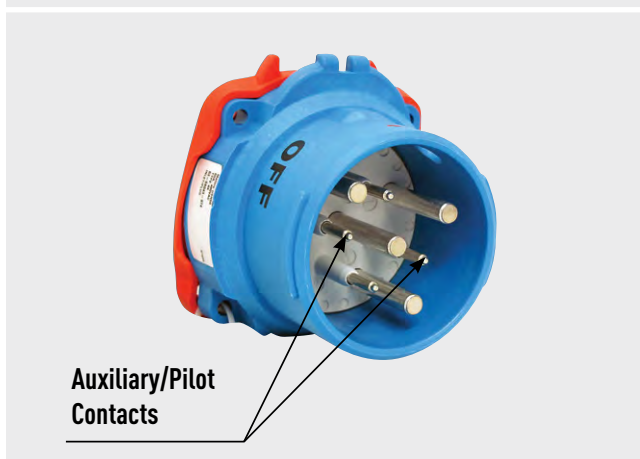

Automatic Watertightness

On most pin and sleeve devices, an additional plastic ring must be tightened in order to ensure the achievement of rated watertightness. Users frequently fail to do this, resulting in leakage. MELTRIC solves this problem with its DS and DSN Switch-Rated plugs and receptacles, which achieve their rated watertightness of up to Type 4X/IP69k simply by mating the plug with the receptacle. After the removal of the plug, rated watertightness is maintained for the receptacle by simply closing the lid.

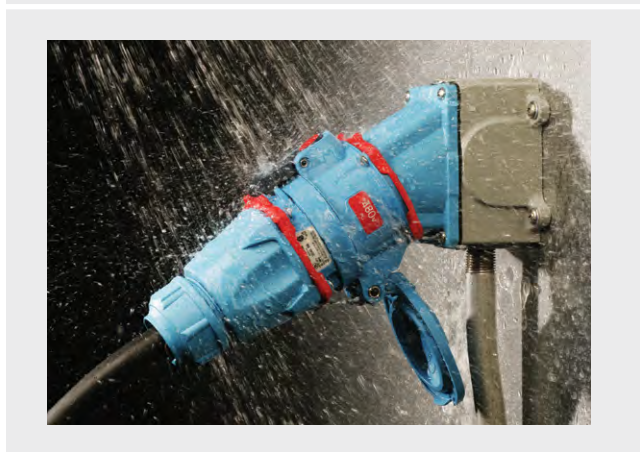

...AND BENEFITS

Spring-Assisted Terminals

The loosening of terminal screws is a common cause for failure on standard plugs and receptacles. MELTRIC provides a more permanent and secure connection with its unique and patented spring-assisted terminal design.

As the terminal screw is tightened against the conductor, the associated pressure expands the split terminal body, causing a spring ring surrounding the terminal to deform into an elliptical shape. The natural tendency for the spring ring to return to its original size and shape ensures that a constant pressure is maintained on the conductor. This allows the terminal to effectively compensate for strand settlement and conductor yield, due to cold flow of the material, and provides superior resistance to vibration, shock and thermal cycling.

Lockout-Tagout Capability

Most MELTRIC plugs and receptacles facilitate compliance with OSHA lockout-tagout requirements. Only a lock or lockout hasp and tag are needed to ensure that the plug is properly locked out and tagged out. Additional mechanisms are not required because the lockout provision is integral to the device – it is always available when you need it. On most models the lockout provision is a simple 5/16" hole in the plug shroud that facilitates the insertion of a typical padlock or lockout hasp which prevents the plug from being inserted into a receptacle.

An optional provision for locking out MELTRIC receptacles is also available. In most cases this is accomplished via a specially machined hole in the receptacle casing which allows insertion of a padlock to secure the receptacle lid in a closed position. This same optional provision can be used to prevent removal of the plug if desired.



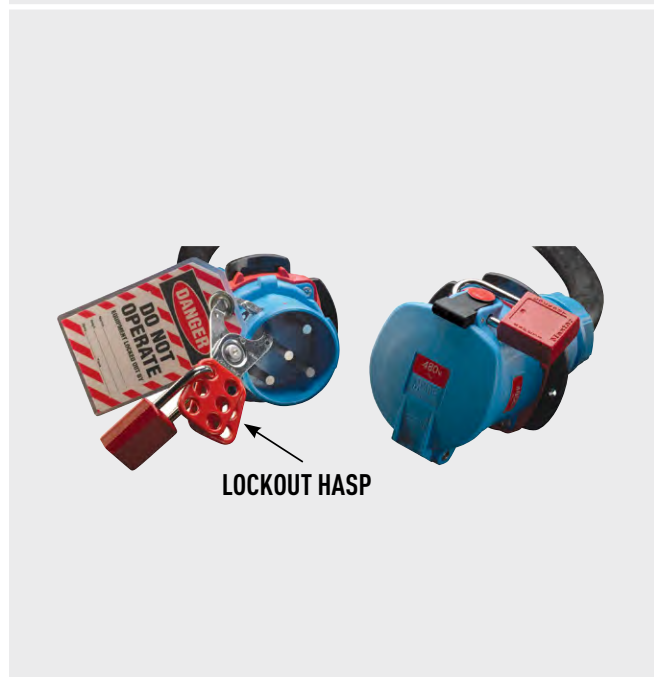
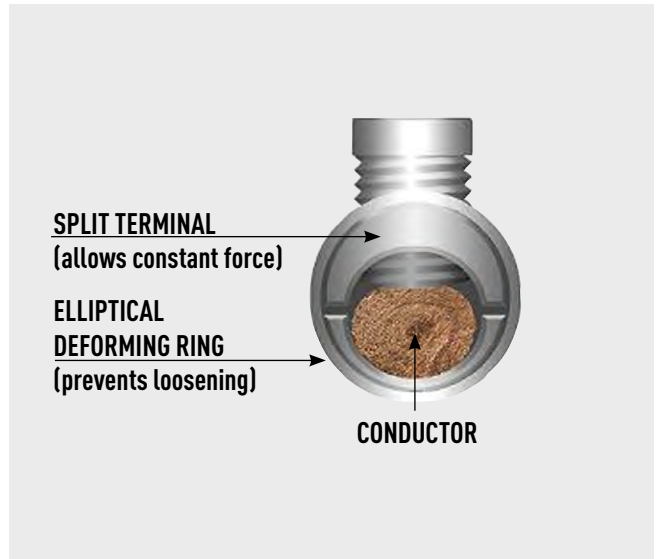

By comparison, in order to lockout most competitive pin and sleeve type plugs, an additional third-party 'lock-out shield' or 'plug cap' is required. These devices can be expensive and are often times lost, broken, or not available when you need them.

Modular Construction

Due to the robust construction of MELTRIC devices, the need to replace worn parts is rare. However, should they be required, parts are readily available and reasonably priced. The modular construction of most MELTRIC devices enables easy replacement of parts in the field.



MELTRIC PRODUCT SUMMARY...



	Model	Amp Rating	Maximum Voltage Rating		Environmental Ratings		Available Casing Materials			Maximum Number of Contacts	
			VAC	VDC	Type	IP	Poly	Metal	SS	Main	Aux.
Switch-Rated	 DSN20	20	600	-	4X	69k	Poly	-	-	3P+N+G	2
	DSN30	30	600	-	4X	69k	Poly	-	-	3P+N+G	2
	DSN60	60	600	-	4X	69k	Poly	-	-	3P+N+G	4
	DSN150	150	600	-	4X	69k	Poly	Metal	-	3P+N+G	6
	DS20	20	600	-	3R	-	Poly	-	-	3P+N+G	2
	DS30	30	600	-	3R	-	Poly	-	-	3P+N+G	4
	 DS60	60	600	-	3R	-	Poly	Metal	-	3P+N+G	4
	DS100C	100	600	-	3R	-	Poly	Metal	-	3P+N+G	4
	DS100	100	600	-	3R	-	Poly	Metal	-	3P+N+G	6
	DS200	200	600	-	3R	-	-	Metal	-	3P+N+G	6
	DB30	30	600	-	-	67	-	Metal	-	3P+N+G	2
	DB60	60	600	-	-	67	-	Metal	-	3P+N+G	2
	DB100	100	600	-	-	67	-	Metal	-	3P+N+G	4
Multipin	 PN7c	15	600	130	-	66/67*	Poly	Metal	SS	6P+G	-
	PN7c	20	600	130	-	66/67*	Poly	Metal	SS	6P+G	-
	PN12c	5	600	-	-	66/67*	Poly	Metal	SS	11P+G	-
	PN12c	7.5	600	-	-	66/67*	Poly	Metal	SS	11P+G	-
	DSN24c	2	480	130	-	66/67	Poly	-	-	24	-
	DSN24c	7.5	480	130	-	66/67	Poly	-	-	24	-
	DS24c	2	250	130	-	-	-	-	SS	24	-
	DS24c	7.5	250	130	-	-	-	-	SS	24	-
	 DSN37c	2	480	130	-	66/67	Poly	-	-	37	-
	DSN37c	7.5	480	130	-	66/67	Poly	-	-	37	-
	DS37c	2	480	130	-	-	-	-	SS	37	-
	DS37c	7.5	480	130	-	-	-	-	SS	37	-
	 DN9c	20	480	130	-	54/55	-	Metal	-	9	-
	DN20c	20	480	130	-	54/55	-	Metal	-	20	-
	DS7c	30	600	130	-	54/55	Poly	Metal	-	7	3
DR7c	50	600	130	-	54/55	Poly	Metal	-	7	3	

...AND SELECTION GUIDE

Model	Current Interruption Rating*	Horsepower Ratings (see catalog section for other voltages)			Main Contacts Wire Size Capacity		Terminal Type
		240V - 3Ø	480V - 3Ø	600V - 3Ø	Min	Max	
DSN20	Switch-Rated	2 hp	5 hp	5 hp	14 AWG	12 AWG	Screw
DSN30	Switch-Rated	5 hp	10 hp	15 hp	14 AWG	8 AWG	Screw
DSN60	Switch-Rated	7 ½ hp	20 hp	20 hp	12 AWG	4 AWG	Screw
DSN150	Switch-Rated	30 hp	75 hp	75 hp	4 AWG	2/0 AWG	Screw
DS20	Switch-Rated	5 hp	7.5 hp	10 hp	14 AWG	8 AWG	Screw
DS30	Switch-Rated	5 hp	15 hp	15 hp	14 AWG	4 AWG	Screw
DS60	Switch-Rated	10 hp	25 hp	25 hp	10 AWG	2 AWG	Screw
DS100C	Switch-Rated	20 hp	50 hp	50 hp	10 AWG	2 AWG	Screw
DS100	Switch-Rated	10 hp	30 hp	-	4 AWG	2/0 AWG	Screw
DS200	Switch-Rated	40 hp	100 hp	100 hp	4 AWG	4/0 AWG	Screw
DB30	Switch-Rated	7 ½ hp	20 hp	25 hp	14 AWG	8 AWG	Screw
DB60	Switch-Rated	15 hp	30 hp	30 hp	8 AWG	3 AWG	Screw
DB100	Switch-Rated	30 hp	60 hp	60 hp	1/0 AWG	2/0 AWG	Screw
PN7c	Current Interrupting	-	-	-	18 AWG	10 AWG	Screw
PN7c	Non-Current Interrupting	-	-	-	18 AWG	10 AWG	Screw
PN12c	Current Interrupting	-	-	-	18 AWG	14 AWG	Solder/Crimp
PN12c	Non-Current Interrupting	-	-	-	18 AWG	14 AWG	Solder/Crimp
DSN24c	Current Interrupting	-	-	-	18 AWG	14 AWG	Solder/Crimp
DSN24c	Non-Current Interrupting	-	-	-	18 AWG	14 AWG	Solder/Crimp
DS24c	Current Interrupting	-	-	-	18 AWG	14 AWG	Solder/Crimp
DS24c	Non-Current Interrupting	-	-	-	18 AWG	14 AWG	Solder/Crimp
DSN37c	Current Interrupting	-	-	-	18 AWG	14 AWG	Solder/Crimp
DSN37c	Non-Current Interrupting	-	-	-	18 AWG	14 AWG	Solder/Crimp
DS37c	Current Interrupting	-	-	-	18 AWG	14 AWG	Solder/Crimp
DS37c	Non-Current Interrupting	-	-	-	18 AWG	14 AWG	Solder/Crimp
DN9c	Current Interrupting	3 hp	5 hp	-	16 AWG	10 AWG	Screw
DN20c	Current Interrupting	1 hp	3 hp	-	16 AWG	10 AWG	Screw
DS7c	Current Interrupting	-	-	-	14 AWG	8 AWG	Screw
DR7c	Non-Current Interrupting	-	-	-	14 AWG	8 AWG	Screw

* 'Switch-Rated' and 'Current Interrupting' ratings apply to alternating current only.

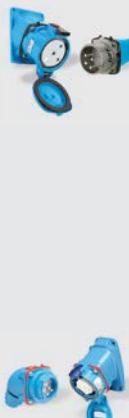
MELTRIC PRODUCT SUMMARY...

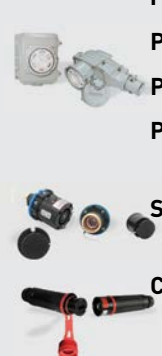
	Model	Amp Rating	Maximum Voltage Rating		Environmental Ratings		Available Casing Materials			Maximum Number of Contacts	
			VAC	VDC	Type	IP	Poly	Metal	SS	Main	Aux.
Standard 	DR30	30	600	-	3R	-	Poly	-	-	3P+N+G	2
	DR50	50	600	-	3R	-	Poly	-	-	3P+N+G	4
	DR100	100	600	-	3R	-	Poly	Metal	-	3P+N+G	4
	DR150	150	600	-	3R	-	Poly	Metal	-	3P+N+G	6
	DR250	250	600	-	3R	-	-	Metal	-	3P+N+G	6
	DR400	400	480**	-	3R	-	-	Metal	-	3P+N+G	2
	PN	15	600	-	-	55 or 66+67*	Poly	Metal	SS	3P+N+G	-
	PN	20	480	-	-	55 or 66+67*	Poly	Metal	SS	3P+N+G	-
	PNHT	30	480	-	-	44	-	Metal	-	3P+N+G	-
Direct Current 	DSDC1	20	-	250	3R	-	Poly	-	-	2P+G	0
	DSDC1	15	-	600	3R	-	Poly	-	-	2P+G	0
	DSDC1	10	-	750	3R	-	Poly	-	-	2P+G	0
	DSDC3	30	-	250	3R	-	Poly	-	-	2P+G	0
	DSDC3	30	-	600	3R	-	Poly	-	-	2P+G	0
	DSDC3	20	-	750	3R	-	Poly	-	-	2P+G	0
	DSDC6	60	-	250	3R	-	Poly	Metal	-	2P+G	0
	DSDC6	50	-	600	3R	-	Poly	Metal	-	2P+G	0
	DSDC6	30	-	750	3R	-	Poly	Metal	-	2P+G	0
	DSDC9	100	-	250	3R	-	Poly	Metal	-	2P+G	0
	DSDC9	60	-	600	3R	-	Poly	Metal	-	2P+G	0
	DSDC2	200	-	250	3R	-	-	Metal	-	2P+G	0
	DSDC2	100	-	600	3R	-	-	Metal	-	2P+G	0
High Ampacity 	PFQ	300	600	250	-	66/67	-	Metal	-	3P+N+G	8
	PF300	300	600	250	-	66/67	-	Metal	-	3P+N+G	4
	PF400	400	600	250	-	66/67	-	Metal	-	3P+N+G	4
	PF600	600	600	250	-	66/67	-	Metal	-	3P+N+G	4
	SP	600	600	1500	-	66/67	Poly	-	-	1P	-
	CS1000	400	1000	1500	-	66/67	Poly	-	-	1P	-

* The indicated ratings do not apply to devices with SS casings.

** 600V available at 350 amps.

¹ Up to 250VAC.

...AND SELECTION GUIDE

Model	Current Interruption Rating*	Horsepower Ratings (see catalog section for other voltages)			Main Contacts Wire Size Capacity		Terminal Type
		240V - 3Ø	480V - 3Ø	600V - 3Ø	Min	Max	
DR30	Non-Current Interrupting	-	-	-	14 AWG	8 AWG	Screw
DR50	Current Interrupting	-	-	-	14 AWG	4 AWG	Screw
DR100	Current Interrupting	-	-	-	10 AWG	2 AWG	Screw
DR150	Current Interrupting	-	-	-	4 AWG	2/0 AWG	Screw
DR250	Non-Current Interrupting	-	-	-	4 AWG	4/0 AWG	Screw
DR400	Non-Current Interrupting	-	-	-	2 AWG	500 MCM	Screw
PN	Current Interrupting	-	-	-	14 AWG	8 AWG	Screw
PN	Current Interrupting	-	-	-	14 AWG	8 AWG	Screw
PNHT	Non-Current Interrupting	-	-	-	14 AWG	8 AWG	Screw
DSDC1	Non-Current Interrupting	-	-	-	14 AWG	8 AWG	Screw
DSDC1	Non-Current Interrupting	-	-	-	14 AWG	8 AWG	Screw
DSDC1	Non-Current Interrupting	-	-	-	14 AWG	8 AWG	Screw
DSDC3	Non-Current Interrupting	-	-	-	14 AWG	6 AWG	Screw
DSDC3	Non-Current Interrupting	-	-	-	14 AWG	6 AWG	Screw
DSDC3	Non-Current Interrupting	-	-	-	14 AWG	6 AWG	Screw
DSDC6	Non-Current Interrupting	-	-	-	10 AWG	2 AWG	Screw
DSDC6	Non-Current Interrupting	-	-	-	10 AWG	2 AWG	Screw
DSDC6	Non-Current Interrupting	-	-	-	10 AWG	2 AWG	Screw
DSDC9	Non-Current Interrupting	-	-	-	8 AWG	2/0 AWG	Screw
DSDC9	Non-Current Interrupting	-	-	-	8 AWG	2/0 AWG	Screw
DSDC2	Non-Current Interrupting	-	-	-	4 AWG	4/0 AWG	Screw
DSDC2	Non-Current Interrupting	-	-	-	4 AWG	4/0 AWG	Screw
PFQ	Non-Current Interrupting	-	-	-	2 AWG	600 MCM	Lug
PF300	Non-Current Interrupting	-	-	-	2 AWG	600 MCM	Lug
PF400	Non-Current Interrupting	-	-	-	2 AWG	600 MCM	Lug
PF600	Non-Current Interrupting	-	-	-	2 AWG	600 MCM	Lug
SP	Non-Current Interrupting	-	500 hp	500 hp	2/0 AWG	777 MCM	Lug
CS1000	Non-Current Interrupting	-	-	-	2/0 AWG	444 MCM	Lug

* 'Current Interrupting' rating applies to alternating current only.

MELTRIC PRODUCT SUMMARY...

Hazardous Location



Model	Amp Rating	Maximum Voltage Rating		Environmental Ratings		Available Casing Materials			Maximum Number of Contacts	
		VAC	VDC	Type	IP	Poly	Metal	SS	Main	Aux.
DXN20	20	480	-	-	66/67	Poly	-	-	3P+N+G	-
DXN30	30	600	-	-	66/67	Poly	-	-	3P+N+G	2
DXN60	60	600	-	-	66/67	Poly	-	-	3P+N+G	2
DXA1	20	550	-	-	66/67	-	Metal	-	3P+N+G	-
DS20	20	600	-	4X	-	Poly	-	-	3P+N+G	2
DS30	30	600	-	4X	-	Poly	-	-	3P+N+G	4
DS60	60	600	-	4X	-	-	Metal	-	3P+N+G	4
DS100C	100	600	-	4X	-	Poly	Metal	-	3P+N+G	4
DSN150	150	600	-	4X	-	-	Metal	-	3P+N+G	6
DS200	200	600	-	4X	-	-	Metal	-	3P+N+G	6
DR30	30	600	-	4X	-	Poly	-	-	3P+N+G	2
DR50	50	600	-	4X	-	Poly	-	-	3P+N+G	4
DR100	150	600	-	4X	-	Poly	Metal	-	3P+N+G	4
DR250	250	600	-	4X	-	-	Metal	-	3P+N+G	6
DSDC1	20	-	250	4X	-	Poly	-	-	2P+G	-
DSDC3	30	-	250	4X	-	Poly	-	-	2P+G	-
DSDC6	60	-	250	4X	-	Poly	Metal	-	2P+G	-
DSDC9	100	-	250	4X	-	-	Metal	-	2P+G	-
DSDC2	200	-	250	4X	-	-	Metal	-	2P+G	-
DX1	20	600	-	-	65	-	Metal	-	3P+N+G	-
DX3	32	600	-	-	65	-	Metal	-	3P+N+G	-
DX6	63	600	-	-	65	-	Metal	-	3P+N+G	-
DX9	125	600	-	-	65	-	Metal	-	3P+N+G	-
PXN12c	10	220	-	-	65/66	-	Metal	-	12	-
DXN25c	10	440	-	-	66/67	-	Metal	-	25	-
DXN37c	10	220	-	-	66/67	-	Metal	-	37	-
SPeX	680	1000	-	-	65/66	Poly	-	-	1P	-

...AND SELECTION GUIDE

Model	Current Interruption Rating	Horsepower Ratings (see catalog section for other voltages)			Main Contacts Wire Size Capacity		Terminal Type
		240V - 3Ø	480V - 3Ø	600V - 3Ø	Min	Max	
DXN20	Current Interrupting	2 hp	5 hp	5 hp	16 AWG	10 AWG	Screw
DXN30	Current Interrupting	5 hp	10 hp	15 hp	14 AWG	6 AWG	Screw
DXN60	Current Interrupting	5 hp	20 hp	20 hp	10 AWG	4 AWG	Screw
DXA1	Current Interrupting	-	-	-	16 AWG	10 AWG	Screw
DS20	Non-Current Interrupting	5 hp	7 1/2 hp	10 hp	14 AWG	8 AWG	Screw
DS30	Non-Current Interrupting	5 hp	15 hp	15 hp	14 AWG	4 AWG	Screw
DS60	Non-Current Interrupting	10 hp	25 hp	25 hp	10 AWG	2 AWG	Screw
DS100C	Non-Current Interrupting	20 hp	50 hp	50 hp	10 AWG	2 AWG	Screw
DSN150	Non-Current Interrupting	30 hp	75 hp	75 hp	4 AWG	2/0 AWG	Screw
DS200	Non-Current Interrupting	TBD	TBD	TBD	4 AWG	3/0 AWG	Screw
DR30	Non-Current Interrupting	-	-	-	14 AWG	8 AWG	Screw
DR50	Non-Current Interrupting	-	-	-	14 AWG	4 AWG	Screw
DR100	Non-Current Interrupting	-	-	-	10 AWG	2 AWG	Screw
DR250	Non-Current Interrupting	-	-	-	4 AWG	4/0 AWG	Screw
DSDC1	Non-Current Interrupting	-	-	-	14 AWG	8 AWG	Screw
DSDC3	Non-Current Interrupting	-	-	-	14 AWG	4 AWG	Screw
DSDC6	Non-Current Interrupting	-	-	-	10 AWG	2 AWG	Screw
DSDC9	Non-Current Interrupting	-	-	-	4 AWG	2/0 AWG	Screw
DSDC2	Non-Current Interrupting	-	-	-	4 AWG	3/0 AWG	Screw
DX1	Current Interrupting	-	-	-	14 AWG	8 AWG	Screw
DX3	Current Interrupting	-	-	-	14 AWG	8 AWG	Screw
DX6	Current Interrupting	-	-	-	6 AWG	1/0 AWG	Screw
DX9	Current Interrupting	-	-	-	1/0 AWG	2/0 AWG	Screw
PXN12c	Non-Current Interrupting	-	-	-	16 AWG	14 AWG	Solder/Crimp
DXN25c	Non-Current Interrupting	-	-	-	16 AWG	14 AWG	Solder/Crimp
DXN37c	Non-Current Interrupting	-	-	-	16 AWG	14 AWG	Solder/Crimp
SPeX	Non-Current Interrupting	-	-	-	2/0 AWG	750 MCM	Lug

MELTRIC PART NUMBERING...



First seven (7) digits for a basic inlet or receptacle part number

One (1) to six (6) suffixes for special features

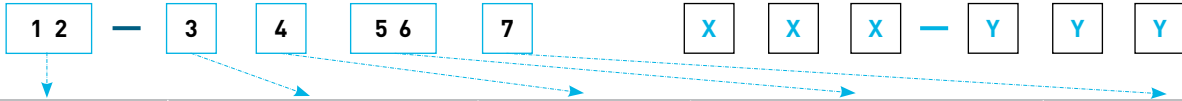

MELTRIC Product Line Type and Casing Material	AMP (A) Rating		Form and Mounting	Voltage Polarization		Phasing
	Position	Voltage		Hz		
PN/PN7c 01 = Blue Poly 09 = Blue Metal	DSN 1 = 20 3 = 30 6 = 60 9 = 150	DXA1 1 = 20	Female 4 = Receptacle	01 = $\frac{220 - 250}{380 - 440}$	50	AC 2 = 2P+G AC 3 = 3P+G AC 5 = 1P+N+G AC 6 = 2P+N+G AC 7 = 3P+N+G AC A+ = 2P AC B+ = 3P AC C+ = 3P+N AC D+ = 1P+N AC G+ = 2P+N AC
PN12c 03 = Blue Poly 07 = Blue Metal	DX 2 = 20* 3 = 30* 6 = 60* 9 = 100*	DS 1 = 20 3 = 30 6 = 60/100C 9 = 100	Male 8 = Inlet	02 = 20/24 03 = $\frac{110 - 130}{190 - 230}$ 04 = $\frac{255 - 277}{440 - 480}$	60 50 60	DC 8** = 2P+G DC 9 = 2P+G DC Z+ = 2P DC P = 2P+2P+G DC
PXN12c 06 = Black Metal	PF 3 = 300* 4 = 400* 6 = 600*	PFQ 3 = 300*	DX, DXN37c, PXN12c, SPeX Only	06 = 25/28 07 = $\frac{110 - 125}{220 - 250}$ 08 = 20/24 09 = 480/500	50 60 50	
DN 17 = Blue Metal	DB 3 = 30* 6 = 60* 9 = 100*	DR 1 = 30 3 = 50 6 = 100 9 = 150 2 = 250* 4 = 400*	Female 0 = Receptacle on box 3 = Connector 4 = Receptacle	10 = 110/130 11 = $\frac{115 - 127}{200 - 220}$ 12 = $\frac{115 - 127}{200 - 220}$ 13 = 40/48	DC 400 200 50	
DXN 22 = Black Poly	PN N = 20 (IP66/ IP67) S = 20 (IP54/ IP55) 2 = 20	DN 1 = 20*(DN9) 6 = 20*(DN20)	Male 1 = Plug 6 = Inlet on Box	14 = 347/600 16 = $\frac{120 - 127}{208 - 220}$ 17* = $\frac{110 - 125}{220 - 250}$ 18* = 347/600 19 = $\frac{380 - 400}{660 - 690}$ 20 = 220/250 22 = 577/1000 23* = $\frac{120 - 127}{208 - 220}$ 24* = $\frac{255 - 277}{440 - 480}$	60 60 60 50 DC 50 60 60	* For DS100C and DR devices.
DXA1 29 = Black Metal						
DX 26 = Black Metal						
DS 33 = Blue Poly 35 = Black Poly 36 = Black Metal (HazLoc) 37 = Blue Metal						
DXN25/37c 36 = Black Metal						
DR 31 = Blue Poly 39 = Blue Metal						
SPeX 42 = Black Poly						
CS1000/SP 45 = Black Poly						
PFQ 47 = Gray Metal						
PF 49 = Gray Metal						
DSN 63 = Blue Poly 65 = Black Poly 66 = Black Metal (HazLoc) 69 = Blue Metal						
DB 89 = Blue Metal						

- Notes:**
- On metal devices, plugs are not painted, receptacles are painted.
 - This is the Keying Standard for MELTRIC products. Suffixes are available to accommodate non-interchangeable devices of the same size at the same voltage. Please ask for more details.

...AND ORDERING GUIDE

A MODULAR SYSTEM

MELTRIC products are ordered and assembled in a modular fashion. Customers should select the desired male inlet and female receptacle part numbers. Then matching accessories such as handles, angles, and junction boxes should be identified and added to the order to create plugs, connectors, or other configurations. This modular system allows MELTRIC to build and ship product to customer specifications in a very short time - 90% of orders ship by the next business day.

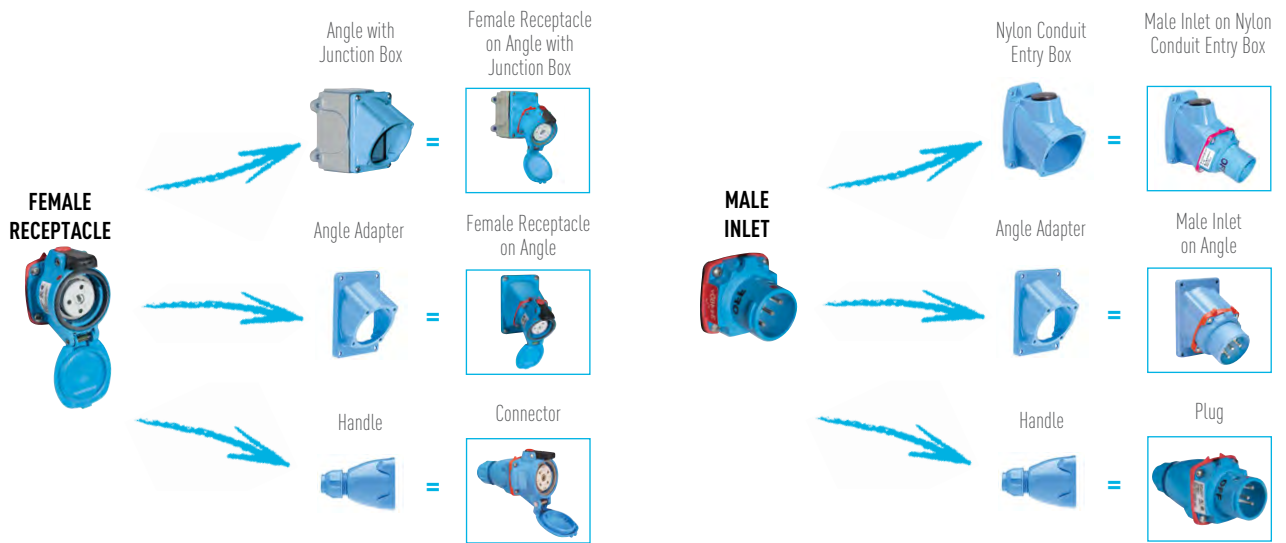



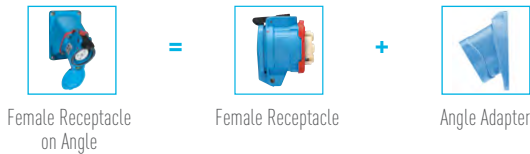

EXAMPLE



EXAMPLE



TYPICAL ORDER

-  63-34047 Female Receptacle
-  512M3 Angle Adapter for Female
-  63-38047 Male Inlet
-  512P0D21 Handle for Male

SWITCH-RATED Plugs & Receptacles

THE MAIN DIFFERENCES



DECONTACTOR™ Technology

Pressing the pawl/button on the receptacle will safely switch off power to the load. The plug can then be withdrawn in complete safety.
(Cutaway model shown for illustration purposes)

Like most MELTRIC products, Switch-Rated plugs and receptacles feature (see pgs 6-8)

- ▶ Spring-loaded butt contacts
- ▶ Silver-nickel contact materials
- ▶ Dead front design
- ▶ Enclosed arc chambers
- ▶ Spring-assisted terminals
- ▶ Auxiliary contacts

MELTRIC Switch-Rated plugs and receptacles have additional features, including:

- ▶ UL & CSA switch-ratings
- ▶ Horsepower ratings
- ▶ Short circuit ratings up to 100 kA in fuse protected circuits

Switch and Hp Ratings

MELTRIC Switch-Rated products are a combination plug, receptacle and disconnect switch in the same device. Their integral switch technology ensures the safe breaking of resistive and inductive loads (up to 75 hp or 200A) before an operator can physically remove the plug from the receptacle.

They are UL and CSA approved for both “branch circuit” and “motor circuit” disconnect switching, making them ideal for connecting motors, welding machines and virtually any other electrical equipment.

Short Circuit Ratings

MELTRIC Switch-Rated plugs and receptacles help ensure worker safety even in fault conditions. They are rated to close into and withstand short circuit currents of 65 kA to 100 kA. The protection far surpasses that offered by other plugs and receptacles, and even surpasses the short circuit protection offered by most manual motor controllers and mechanical interlocks.



To match the functionality of a Switch-Rated device, it would take a pin and sleeve plug plus a non-fused safety switch.

UL & CSA Standards

Test requirements and ratings comparison table

To achieve their UL 2682 switch ratings, MELTRIC Switch-Rated plugs and receptacles have passed tests that far exceed those of ordinary plugs and receptacles. These tests include horsepower/locked rotor overload tests from the UL 508 Standard for Industrial Control Equipment and electrical endurance and short-circuit make-and-withstand testing from the UL 98 standard for Enclosed and Dead Front Switches.

To illustrate how the electrical and mechanical endurance of MELTRIC Switch-Rated plugs and receptacles far exceeds standard plugs, the following chart compares the test requirements for achieving a Switch-Rated plug & receptacle listing with those required for a standard pin and sleeve plug & receptacle listing.

Test	UL 1682 & CSA 22.2 No. 182.1		UL Subject 2682 (used for both UL & CSA listings)
	Plugs, Receptacles & Cable Connectors of the Pin & Sleeve Type		Switch-Rated Plugs & Receptacles
	Non-Current Interrupting Break (minimum requirements)	Current Interrupting (minimum requirements)	Motor Circuit/Branch Circuit Disconnect Switching (Tests passed by MELTRIC devices)
Temperature Rise	< 30°C	< 30°C	< 30°C
Voltage Withstand	3,000VAC for 1 Minute	3,000VAC for 1 Minute	3,000VAC for 1 Minute
Overload General Use Devices	3 Operations @ 150% Rated Current (p.f. = .75 - .80)	50 Operations @ 150% Rated Current (p.f. = .75 - .80)	50 Operations @ 150% Rated Current (p.f. = .75 - .80)
Mechanical Endurance (Plus Req'd Electrical Opns)	15-20A = 5000 Operations 21-63A = 2000 Operations 64-250A = 250 Operations	15-20A = 0 Operations 21-63A = 1000 Operations 64-250A = 500 Operations	4000 Cycles
Electrical Endurance (with load)	-	15-20A = 5000 Operations 21-63A = 1000 Operations ¹ 64-250A = 250 Operations ¹ @ Rated Current & Voltage (p.f. = .75 - .80)	6000 Operations @ Rated Current & Voltage (p.f. = .75 - .80)
Overload - Locked Rotor (Horsepower Rated Devices)	-	50 Operations @ 600% of Full Load Motor Current (p.f. = .40 - .50)	50 Operations @ 600% of Full Load Motor Current (p.f. = .40 - .50)
Short Circuit Withstand	-	≥ 10 kA ⁺ (600V and ≤ .50 power factor)	≥ 10 kA ⁺ (600V and ≤ .50 power factor)
Short Circuit Closing	-	-	≥ 10 kA ⁺ (600V and ≤ .50 power factor)

¹ Testing alternates between mechanical & electrical operations. This reduces the severity of the electrical test by allowing additional cooling time during electrical testing.
⁺ All MELTRIC Switch-Rated devices are UL listed with short circuit ratings of at least 65kA achieved at 600VAC and ≤ .15 power factor.



BENEFIT FROM USING MELTRIC SWITCH-RATED DEVICES...

Ensure Worker Safety

Switch-Rated plugs and receptacles ensure safety by eliminating hazards associated with pin & sleeve and twist-type devices.

- ▶ The integral switching function ensures that the plug contacts are deenergized before an operator can remove the plug from the receptacle. The dead front design prevents unintended access to live parts.
- ▶ Spring-loaded, silver-nickel butt style contacts maintain proper contact force, withstand arcing, resist wear, and maintain low contact resistance. This ensures the integrity of the connection over thousands of operations and eliminates performance and safety problems common to plugs with brass contacts.
- ▶ Spring-loaded plug and receptacle disengagement with push button operation ensures fast and easy load breaking, which minimizes arcing during disconnection. Enclosed arc chambers eliminate the possibility of external arcs that could be a safety hazard for the operator.
- ▶ Horsepower, switch and short circuit ratings provide additional protection during locked-rotor or other significant overload situations.



Simplify Code Compliance

Switch-Rated devices provide a simple and cost effective means of helping facilities to achieve compliance with the National Electric Code and NFPA 70E.

NEC Compliance

Articles 430.101 to 430.113 of the National Electrical Code regulate the means of motor disconnection (Canadian Electrical Code section 28-600-28-604). They require motors to have readily accessible, 'line of sight' disconnects that are an approved switch or a properly rated plug and receptacle.

- ▶ **430.102** A disconnecting means must be located in sight of the motor and driven equipment.
- ▶ **430.107** The disconnecting means must be readily accessible.
- ▶ **430.109** The disconnecting means must be an approved switch or horsepower rated plug & receptacle.

MELTRIC Switch-Rated plugs and receptacles are both horsepower and switch-rated. Thus, they can function as a 'line of sight' disconnect in addition to providing a convenient plug and play power connection for the motor. By installing a Switch-Rated device, the need for an auxiliary disconnect switch is eliminated.

NFPA 70E (CSA Z462)

This OSHA consensus standard covers electrical safety related work practices and procedures for employees who work on or near exposed energized electrical conductors or other live circuit parts. Relevant requirements include:

Power must be proven to be off before work can be performed. This requires:

- ▶ The safe interruption of the load & opening of the disconnect
- ▶ Visual verification/voltage testing to ensure deenergization

The potential electrical hazard must be identified and documented.

- ▶ An arc flash risk assessment must be performed
- ▶ Flash protection boundaries must be determined

Appropriate steps must be taken to protect persons working near live parts or within the flash protection boundary.

- ▶ PPE must be worn based on incident energy exposure levels (cal/cm²)
- ▶ Only properly qualified persons are allowed to perform work

...THROUGHOUT YOUR FACILITY

Wiring and connection systems utilizing conventional switches and/or pin & sleeve devices would typically require all of the previously listed protective measures to comply with NFPA 70E or CSA Z462. By using MELTRIC Switch-Rated plugs and receptacles to connect equipment, users can very simply comply with these requirements.

Switch ratings ensure the safe interruption of the load. Visual verification that the power is off is provided when the plug is removed from the receptacle. A dead front design prevents an operator from being exposed to live parts, eliminating the need to perform hazard analysis, establish flash protection boundaries and use electrical personal protective equipment.

A Comparison of the Motor Change-Out Process

MOTOR HARD-WIRED TO A BLADED DISCONNECT SWITCH	MOTOR CONNECTED WITH A MELTRIC MOTOR PLUG	MOTOR CONNECTED WITH A COMPETING PLUG & RECEPTACLE
<p>The disconnect switch may be difficult to install in "line of sight" of the motor.</p> <p>18"</p> <p>Qualified Worker w/PPE</p>	<p>OR</p> <ul style="list-style-type: none"> ▶ Cord connection allows easy "line of sight" location ▶ Dead front eliminates access to live parts and need for cumbersome PPE ▶ Ability to safely make & break under load eliminates the need for interlocks ▶ ≥ 65kA short circuit make-and-withstand rating ensures safety during reenergization <p>OR</p>	<ul style="list-style-type: none"> ▶ Expensive mechanical interlocks are required since these plugs & receptacles cannot safely make & break under load ▶ The interlock must be mounted on a fixed surface this may make "line of sight" location more difficult
MOTOR CHANGE-OUT PROCESS	MOTOR CHANGE-OUT PROCESS	MOTOR CHANGE-OUT PROCESS
<ol style="list-style-type: none"> 1. Switch disconnect to OFF position 2. Apply lockout/tagout 3. Perform Shock/Arc Flash Risk Assessment 4. Obtain permit for energized electrical work 5. Suit up with appropriate PPE 6. Remove the disconnect switch cover 7. Voltage test to verify deenergization 8. Disconnect motor from hard-wiring 9. Remove old/install new motor 10. Connect new motor to hard-wiring 11. Jog the motor to ensure proper rotation 	<ol style="list-style-type: none"> 1. Depress the pawl on the receptacle to break the circuit. 2. Mechanic removes plug from receptacle 3. Apply lockout/tagout as required 4. Mechanic removes old /installs new motor 5. Mechanic inserts plug into receptacle <p>MELTRIC Makes it Safe & Easy</p>	<ol style="list-style-type: none"> 1. Open interlock switch 2. Determine PPE requirements and obtain permit for electrical work 3. Remove interlock cover 4. Verify deenergization with a voltmeter test 5. Remove plug 6. Apply lockout/tagout as required 7. Remove old/install new motor 8. Insert plug into receptacle

Reduce Equipment & Installation Costs

The ability of MELTRIC Switch-Rated devices to safely make and break under full load eliminates the need for the expensive interlocks that are required with pin and sleeve devices. Their ability to function as the NEC required 'line of sight' disconnect switch eliminates the need for auxiliary disconnect switches. Optional pilot contacts can eliminate the need of auxiliary connectors in control circuits.

Reduce Equipment Change-out Downtime & Cost

Using MELTRIC Switch-Rated plugs and receptacles to connect motors and other equipment instead of hard-wiring can help reduce equipment change-out time by as much as 50%. With new motors pre-wired with MELTRIC plugs or inlets, the only electrical connection required during the change-out will be to plug in the new motor. Thus, a mechanic will be able to perform the change-out without the immediate aid of an electrician. This avoids the inconvenience of scheduling an electrician for a service call. So, extra downtime required to do the wiring is eliminated. The pre-wiring of replacement motors with MELTRIC plugs or inlets can be done off-site and during the convenience of non-downtime periods. This makes MELTRIC plugs and receptacles an ideal choice for 'plug and play' and modular process applications.

SELECTING THE RIGHT MELTRIC SWITCH-RATED PLUG & RECEPTACLE

All SWITCH-RATED devices (DSN, DS and DB) feature DECONTACTOR™ Technology:



- ▶ UL & CSA switch-ratings
- ▶ Short circuit closing and withstand protection (65kA to 100kA)



- ▶ Silver-nickel contact material
- ▶ Spring-loaded, butt-style contacts



- ▶ Dead front safety shutter
- ▶ Optional auxiliary contacts



DSN Series (pages 24-37)

Choose DSN Series for its...

- ▶ Compact, lightweight design
- ▶ Automatic Type 4X/IP69k watertightness
- ▶ High HP Ratings (up to 75 hp)

Common Applications

- ▶ Wet or washdown environments
- ▶ Plug & play electrical connections



DS Series (pages 38-55)

Choose DS Series for its...

- ▶ High amperage range (up to 200A)
- ▶ Poly or metal casing materials (60A and above)
- ▶ Larger conductor capacities

Common Applications

- ▶ Heavy industry
- ▶ High amperage equipment



DB Series (pages 56-69)

Choose DB Series for its...

- ▶ Robust, heavy duty construction

Common Applications

- ▶ Motors with frequent make and break requirements
- ▶ Harsh environments

DSN Models and Ratings

Model	Casing Material	Maximum Voltage (VAC)	Amperage Rating	Maximum Number of Contacts		Environmental Rating	Maximum Horsepower Rating	
				Main	Auxiliary		480 VAC	600 VAC
DSN20	Poly	600 VAC	20A	3P+N+G	2 pilots	Type 4X/IP69k	5 hp	5 hp
DSN30	Poly	600 VAC	30A	3P+N+G	2	Type 4X/IP69k	10 hp	15 hp
DSN60	Poly	600 VAC	60A	3P+N+G	4	Type 4X/IP69k	20 hp	20 hp
DSN150	Poly or Metal	600 VC	150A	3P+N+G	6	Type 4X/IP69k	75 hp	75 hp

DS Models and Ratings

Model	Casing Material	Maximum Voltage (VAC)	Amperage Rating	Maximum Number of Contacts		Environmental Rating	Maximum Horsepower Rating	
				Main	Auxiliary		480 VAC	600 VAC
DS20	Poly	600 VAC	20A	3P+N+G	2	Type 3R	7.5 hp	10 hp
DS30	Poly	600 VAC	30A	3P+N+G	4	Type 3R	15 hp	15 hp
DS60	Poly	600 VAC	60A	3P+N+G	4	Type 3R	25 hp	25 hp
DS100C	Poly or Metal	600 VAC	100A	3P+N+G	4	Type 3R	50 hp	50 hp
DS100	Poly or Metal	600 VAC	100A	3P+N+G	6	Type 3R	30 hp	-
DS200	Metal	600 VAC	200A	3P+N+G	6	Type 3R	100 hp	100 hp

DB Models and Ratings

Model	Casing Material	Maximum Voltage (VAC)	Amperage Rating	Maximum Number of Contacts		Environmental Rating	Maximum Horsepower Rating	
				Main	Auxiliary		480 VAC	600 VAC
DB30	Zinc Aluminum	600 VAC	30A	3P+N+G	2	IP67	20 hp	25 hp
DB60	Zinc Aluminum	600 VAC	60A	3P+N+G	2	IP67	30 hp	30 hp
DB100	Zinc Aluminum	600 VAC	100A	3P+N+G	4	IP67	60 hp	60 hp

SWITCH-RATED

Plugs & Receptacles



MELTRIC's Switch-Rated product line featuring DECONTACTOR™ technology, includes devices rated from 20 amps to 200 amps. An integral switch mechanism enables workers to safely connect and disconnect motors, welding machines and other industrial equipment.



DSN P. 24

COMPACT AND IP69K WATERTIGHTNESS

- 20A to 150A (75 hp)
- Automatic Type 4X/IP69K watertightness



DS P. 38

LARGER WIRING CAPACITY AND METAL CASINGS

- 20A to 200A, Type 3R (4X optional)
- Poly or metal casings (60A and above)
- Larger conductor capacities



DB P. 56

ROBUST CONSTRUCTION

- 30A to 100A
- Heavy duty construction, high impact resistance

DSN Switch-Rated plug and receptacle with Type 4X/IP69k protection



Main Advantages

- ▶ Switch & Hp rated
- ▶ 100 kA short circuit rated*
- ▶ Type 4X/IP69k or IP66/IP67
- ▶ Compact, lightweight design
- ▶ Up to 6 auxiliary contacts

* See note under General Ratings on the next page.



Highlighted Advantage

! Simplify Compliance to NFPA 70E & CSA Z462 see pgs 18-19 for more information



- | | | | |
|------------------------|-------|---------------|-------|
| ▶ Features and Ratings | p. 25 | ▶ DSN150 | p. 32 |
| ▶ DSN20 | p. 26 | ▶ Spare parts | p. 34 |
| ▶ DSN30 | p. 28 | ▶ Dimensions | p. 36 |
| ▶ DSN60 | p. 30 | | |

PRODUCT FEATURES

DECONTACTOR™ Technology

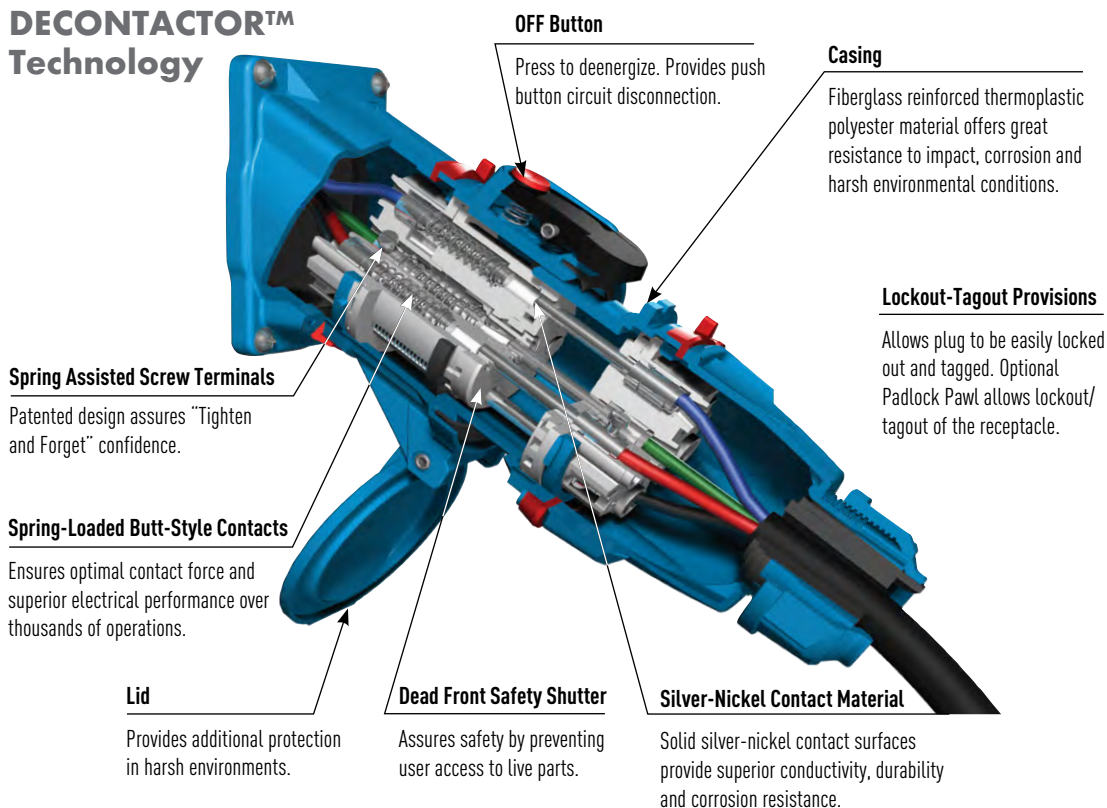

Operating Instructions



When the plug and receptacle are latched together, the circuit is connected.



Pressing the pawl breaks the connection and opens the circuit. The plug is ejected to its rest position; The contacts are now dead.



Rotating the 'dead' plug 30° counterclockwise closes the safety shutter and frees the plug to be withdrawn from the receptacle.



The plug and the receptacle are separated. The safety shutter prevents access to live parts.

5 To reconnect, insert plug into receptacle, rotate 30° clockwise, and apply insertion force.

General Ratings

Amperage	20 to 150A
Voltage	600 VAC
Frequency	50-400 Hz
Horsepower	1/2 to 75 hp
Short-Circuit (Make & Withstand)	100kA*
Environmental	Type 4X/IP69k
Temperature	min -40°F/max 140°F

* DSN20, DSN30, DSN60: Testing was performed with RK1 current limiting fuses sized at 400% or more of the highest full load motor ampacity associated with the devices horsepower ratings.

* DSN150: 100kA testing was performed with 225A RK1 non-time delay Mersen fuses. 10kA testing was performed with 400A RK1 non-time delay Mersen fuses.

Highlighted Feature

Typical Device Labels

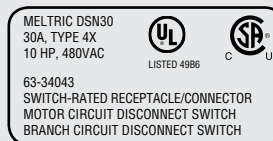

Meltric DSN Series Switch-Rated devices are UL & CSA rated for "motor circuit" and "branch circuit" disconnect switching – up to 75 hp and up to 150A.

Listings

Category	UL	CSA	IEC
Plugs and Receptacles	UL 1682	C22.2 No. 182.1	60309-1
Branch Circuit Disconnect Switching (AC only)	UL Subject 2682 (Performance tests from UL 98)	UL Subject 2682	60947-3, AC22, AC23
Motor Circuit Disconnect Switching (AC only)	UL Subject 2682 (Performance tests from UL 98)	UL Subject 2682	60947-3, AC22, AC23

CE ratings available upon request.

DSN20 Switch-Rated Plugs & Receptacles – 20A

UL/CSA Ratings

- **Max Amperage & Voltage**
20A, 600 VAC
- **Switch-Rating (AC Only)**
Branch Circuit & Motor Circuit Disconnect Switching
- **Horsepower Ratings**

120V	1Ø	.75 hp
240V	1Ø	2 hp
208V	3Ø	3 hp
240V	3Ø	3 hp
480V	3Ø	7.5 hp
600V	3Ø	7.5 hp
- **Short Circuit Rating**
100kA Close & Withstand
Testing was performed with RK1 current limiting fuses sized at 400% of the highest full load motor ampacity associated with the devices hp rating.
- **Environmental Ratings**
Type 4X/IP69k*
*Also meets IP66/IP67 requirements
- **Temperature Range**
Min -40°F/Max 140°F
See pg 271 for temps below -15°F.
- **Wiring Capacity**
Min 14 AWG Max 12 AWG
Aux Contacts - 14 AWG prewired
- **Certifications**
UL 2682, UL 1682, CSA 182.1

Receptacle (female)



Inlet (male)



! Don't forget to add installation accessories to your order

North American UL/CSA Configurations

Voltage	Polarity	Part # Poly	Part # Poly
120V	1P+N+G	63-14165	63-18165
120 208V	3P+N+G	63-14167	63-18167
125V	1P+N+G	63-14075	63-18075
125 250V	2P+N+G	63-14076	63-18076
208V	2P+G	63-14162	63-18162
208V	3P+G	63-14163	63-18163
250V	2P+G	63-14072	63-18072
250V	3P+G	63-14073	63-18073
277V	1P+N+G	63-14045	63-18045
277 480V	3P+N+G	63-14047	63-18047
347 600V	3P+N+G	63-14147	63-18147
480V	2P+G	63-14042	63-18042
480V	3P+G	63-14043	63-18043
600V	2P+G	63-14142	63-18142
600V	3P+G	63-14143	63-18143

For international configurations and ratings (IEC, CE) visit meltric.com/international-catalog or contact customer service at 800.433.7642.

Main Options



Mushroom Pawl



Padlock Pawl



Closed Lid Configuration

Recommended for cold applications to keep lid tucked in to avoid damage.

Receptacle Options

Suffix

Inlet Options

Suffix

With Pilot Circuit	Recept # - 972+	Self-Ejecting Plug Release	Inlet # - 338
Straight Insertion	Recept # - 352	With No Lockout Hole	Inlet # - A155
Self-Ejecting Connector Release	Recept # - 354		
Mushroom Pawl	Recept # - 375		
Padlock Pawl	Recept # - 843		
Padlockable Mushroom Pawl	Recept # - 375-843		
Metal Pawl	Recept # - 824		
Closed Lid Configuration	Recept # - NC		



Notes: * Unlike other DSN & DS products, the DSN20 pilots are only on the receptacle side and create a continuity loop that is completed when a plug is connected to the receptacle. CSA listing is expected in Q3 2019.





! See pages 248-257 for detailed information on these options

Order Example: 480V DSN20 with padlock pawl
DSN20 Receptacle 3P+G = 63-14043-843

INSTALLATION ACCESSORIES – SIZE 1

HANDLES

HANDLE w/NPT	Part # Poly	Part # Metal
 1/2"	511P0N05	791P0N05L
 3/4"	511P0N07	791P0N07L
 1"	511P0N10	791P0N10L

HANDLE w/CORD GRIP	Cable Range	Poly	Metal
 .438 - .500"		711P0BP3	791P0BS3L
 .500 - .562"		711P0BP4	791P0BS4L
 .562 - .625"		711P0BP5	791P0BS5L
 .625 - .750"		711P0CP4	791P0CS4L

NYLON HANDLE w/Cable Range	Part #	Notes
 .35 - .70"	511P0D18	Finger draw plates are recommended for easier connector closure on cord to cord assemblies.

EXTENDED HANDLE	Part #
 .20 - .82"	511P0D21

ANGLED NYLON HANDLE w/Cable Range	Part #
 .35 - .70"	511P6D18

For available cord grips, see pg 178.

Cable Range	NPT	Notes
.312 - .625	1/2"	NPT sizes are determined by the cable diameter and third party cord grip.
.438 - .812	3/4"	
.660 - 1.000	1"	

ANGLES



NYLON ANGLE	Part #
 30° for MB Box	511M3

METAL ANGLE	Part #
 0°	591M0





Part #	Notes
 FS/FD Box 30°	791M3FS * Base measures approximately 4.2" x 2.7". Due to the variation in sizes of FS boxes, please verify that your FS box matches our dimensions, if not call Customer Service for other solutions.



Part #	Notes
 45°	591M4





BOXES

POLY CONDUIT ENTRY w/NPT	Part #	Notes
 30° 1/2"	511B3N05	* Interior volume with receptacle installed.
 30° 3/4"	511B3N07	

POLY WALL BOX w/NPT	Part #	Notes
 70° 1/2" - 1 1/4"	511C7000	70° poly boxes are not drilled. Contact customer service if factory drilled is required. * Interior volume with receptacle installed.

POLY ANGLE WITH ALUMINUM WALL BOX w/NPT	Part #	Notes
 70° 1/2"	711C7N05	* Interior volume with receptacle installed.
 70° 3/4"	711C7N07	
 70° 1"	711C7N10	
 70° 1 1/4"	711C7N12	
 70° 1 1/2"	711C7N15	

METAL BOX w/NPT	Part #
 0° 1/2"	7T1F0N05
 0° 3/4"	7T1F0N07
 0° 1"	7T1F0N10
 0° 1 1/4"	7T1F0N12

METAL BOX WITH NYLON ANGLE w/NPT	Part #	Notes
 30° 1/2"	711C3N05	* Interior volume with receptacle installed.
 30° 3/4"	711C3N07	
 30° 1"	711C3N10	
 30° 1 1/4"	711C3N12	

NPT on top or bottom (if rotated). For other NPT configurations, contact customer service.

MISCELLANEOUS ACCESSORIES

FINGER DRAWPLATES	Part #	Notes
 Set of Two (2)	61-1A346	Recommended for cord to cord assembly applications, for easier connector closure.

PROTECTIVE CAP	Part #	Notes
 For Male Devices Only.	61-1A426	

PADLOCKABLE PLUG CAP	Part #	Notes
 For Male Devices Only.	61-1A826	

SCREWDRIVER FOR TERMINAL SCREWS	Part #	Notes
 Klein 608-3 1/8" cabinet with 3" round shank.	SD18	

EASY RETROFIT ADAPTER PLATES	Part #	Notes
 Mount to existing boxes.	see pg 175	

RECEPTACLE LOCKING PIN	Part #	Notes
 Requires Padlockable Pawl option (-843) on receptacle.	LP-843	

DSN30 Switch-Rated Plugs & Receptacles – 30A

UL/CSA Ratings

- **Max Amperage & Voltage**
30A, 600 VAC
- **Switch-Rating (AC Only)**
Branch Circuit & Motor Circuit Disconnect Switching
- **Horsepower Ratings**

120V	1Ø	1 hp
240V	1Ø	3 hp
208V	3Ø	5 hp
240V	3Ø	5 hp
480V	3Ø	10 hp
600V	3Ø	15 hp
- **Short Circuit Rating**
100kA Close & Withstand
Testing was performed with RK1 current limiting fuses sized at 400% of the highest full load motor ampacity associated with the devices hp rating.
- **Environmental Ratings**
Type 4X/IP69k*
*Also meets IP66/IP67 requirements
- **Temperature Range**
Min -40°F/Max 140°F
See pg 271 for temps below -15°F.
- **Wiring Capacity**
Min 14 AWG Max 8 AWG
Aux Contacts - 14 AWG
- **Certifications**
UL 2682, UL1682, CSA 182.1

Receptacle (female)



Inlet (male)



! Don't forget to add installation accessories to your order

North American UL/CSA Configurations

Voltage	Polarity	Part # Poly	Part # Poly
120V	1P+N+G	63-34165	63-38165
120 208V	3P+N+G	63-34167	63-38167
125V	1P+N+G	63-34075	63-38075
125 250V	2P+N+G	63-34076	63-38076
208V	2P+G	63-34162	63-38162
208V	3P+G	63-34163	63-38163
250V	2P+G	63-34072	63-38072
250V	3P+G	63-34073	63-38073
277V	1P+N+G	63-34045	63-38045
277 480V	3P+N+G	63-34047	63-38047
347 600V	3P+N+G	63-34147	63-38147
480V	2P+G	63-34042	63-38042
480V	3P+G	63-34043	63-38043
600V	2P+G	63-34142	63-38142
600V	3P+G	63-34143	63-38143

For international configurations and ratings (IEC,CE) visit meltric.com/international-catalog or contact customer service at 800.433.7642.

Main Options



Auxiliary/Pilot Contacts



Mushroom Pawl



Padlock Pawl



Closed Lid Configuration
Recommended for cord applications to keep lid tucked in to avoid damage.

Receptacle Options

Suffix

Inlet Options

Suffix

- With 2 Auxiliary/Pilot Contacts
- Straight Insertion
- Self-Ejecting Connector Release
- Mushroom Pawl
- Padlock Pawl
- Padlockable Mushroom Pawl
- Metal Pawl
- Closed Lid Configuration
- With Auxiliary Switch

- Recept # - 972**
- Recept # - 352**
- Recept # - 354**
- Recept # - 375**
- Recept # - 843**
- Recept # - 375-843**
- Recept # - 824**
- Recept # - NC**
- Recept # - 270+**

- With 2 Auxiliary/Pilot Contacts
- Self-Ejecting Plug Release
- With No Lockout Hole
- For Auxiliary Switch*

Notes: * Order inlet with P+N+G configuration and receptacle with P+G configuration.





Notes: + Not UL/CSA listed.



! See pages 248-257 for detailed information on these options

Order Example: 480V DSN30 + 2 auxiliary contacts
DSN30 Inlet 3P+G = 63-38043-972





INSTALLATION ACCESSORIES – SIZE 2

HANDLES

HANDLE w/NPT	Part # Poly	Part # Metal
 1/2"	512P0N05	592P0N05
 3/4"	512P0N07	592P0N07
 1"	512P0N10	592P0N10
 1 1/4"	512P0N12	-

HANDLE w/CORD GRIP	Cable Range	Poly	Metal
	.625 - .750"	712P0CP4	792P0CS4
	.770 - .875"	712P0DP2	792P0DS1
	.875 - 1.000"	712P0DP3	792P0DS3

POLY HANDLE w/Cable Range	Part #
 .20 - .83"	512P0D21

POLY HANDLE W/CLAMP & BUSHING w/Cable Range	Part #
 .750 - .875"	712P0S14
 .875 - 1.000"	712P0S16
 1.000 - 1.125"	712P0S18
 1.125 - 1.250"	712P0S20
 1.250 - 1.375"	712P0S22

For available cord grips, see page 164.

Cable Range	NPT	Cable Range	NPT
.312 - .625"	1/2"	.660 - 1.000"	1"
.438 - .812"	3/4"	.875 - 1.375"	1 1/4"

NPT sizes are determined by the cable diameter and third party cord grip.

ANGLES

POLY ANGLE	Part #
 30°	512M3



 70°	512M7
---	-------

METAL ANGLE	Part #
 0°	592M0

 30°	592M3
---	-------

 FS/FD Box 30°	792M3FS	* Base measures approximately 4.2" x 2.7". Due to the variation in sizes of FS boxes, please verify that your FS box matches our dimensions, if not call Customer Service for other solutions.
---	---------	--

BOXES

POLY CONDUIT ENTRY w/NPT	Part #
 30° 1/2"	512B3N05
 30° 3/4"	512B3N07

* 8.5 in³

* Interior volume with receptacle installed.

POLY WALL BOX w/NPT	Part #
 70° 1/2 - 1 1/4"	512C7000

* 82.0 in³





70° poly boxes are not drilled. Contact customer service if factory drilled is required.
* Interior volume with receptacle installed.

POLY ANGLE WITH ALUMINUM WALL BOX w/NPT	Part #
 70° 1/2"	712C7N05
 70° 3/4"	712C7N07
 70° 1"	712C7N10
 70° 1 1/4"	712C7N12
 70° 1 1/2"	712C7N15

* 74.6 in³

* Interior volume with receptacle installed.

METAL BOX w/NPT	Part #
 0° 1/2"	7T1F0N05
 0° 3/4"	7T1F0N07
 0° 1"	7T1F0N10
 0° 1 1/4"	7T1F0N12

POLY ANGLE WITH METAL BOX w/NPT	Part #
 30° 1/2"	712C3N05
 30° 3/4"	712C3N07
 30° 1"	712C3N10
 30° 1 1/4"	712C3N12

* 28.7 in³

* Interior volume with receptacle installed.

NPT on top or bottom (if rotated). For other NPT configurations, contact customer service.

MISCELLANEOUS ACCESSORIES

FINGER DRAWPLATES	Part #	Description
	61-3A346	Set of Two (2) Recommended for cord to cord assembly applications, for easier connector closure.

PROTECTIVE CAP	Part #	Description
	61-3A426	For Male Devices Only.

PADLOCKABLE PLUG CAP	Part #	Description
	61-3A826	For Male Devices Only.

SPRING-LOADED PADLOCKABLE CAP	Part #	Description
	61-3A226	Metal - For Male Devices Only.

SCREWDRIVER FOR TERMINAL SCREWS	Part #	Description
	SD18	Klein 608-3 1/8" cabinet with 3" round shank.

RECEPTACLE LOCKING PIN	Part #	Description
	LP-843	Requires Padlockable Pawl option (-843) on receptacle.

DSN60 Switch-Rated Plugs & Receptacles – 60A

UL/CSA Ratings

- Max Amperage & Voltage**
60A, 600 VAC
- Switch-Rating (AC Only)**
Branch Circuit & Motor Circuit Disconnect Switching
- Horsepower Ratings**

120V	1Ø	2 hp
240V	1Ø	3 hp
208V	3Ø	7 1/2 hp
240V	3Ø	7 1/2 hp
480V	3Ø	20 hp
600V	3Ø	20 hp
- Short Circuit Rating**
100kA Close & Withstand
Testing was performed with RK1 current limiting fuses sized at 400% of the highest full load motor ampacity associated with the devices hp rating.
- Environmental Ratings**
Type 4X/IP69k*
*Also meets IP66/IP67 requirements
- Temperature Range**
Min -40°F/Max 140°F
See pg 271 for temps below -15°F.
- Wiring Capacity**
Min 12 AWG Max 4 AWG
Aux Contacts - Max 14 AWG
- Certifications**
UL 2682, UL1682, CSA 182.1

Receptacle (female)



Inlet (male)



! Don't forget to add installation accessories to your order

North American UL/CSA Configurations

Voltage	Polarity	Part # Poly	Part # Poly
120V	1P+N+G	63-64165	63-68165
120 208V	3P+N+G	63-64167	63-68167
125V	1P+N+G	63-64075	63-68075
125 250V	2P+N+G	63-64076	63-68076
208V	2P+G	63-64162	63-68162
208V	3P+G	63-64163	63-68163
250V	2P+G	63-64072	63-68072
250V	3P+G	63-64073	63-68073
277V	1P+N+G	63-64045	63-68045
277 480V	3P+N+G	63-64047	63-68047
347 600V	3P+N+G	63-64147	63-68147
480V	2P+G	63-64042	63-68042
480V	3P+G	63-64043	63-68043
600V	2P+G	63-64142	63-68142
600V	3P+G	63-64143	63-68143

For international configurations and ratings (IEC, CE) visit meltric.com/international-catalog or contact customer service at 800.433.7642.

Main Options



Auxiliary/Pilot Contacts



Mushroom Pawl



Padlock Pawl



Closed Lid Configuration

Recommended for cord applications to keep lid tucked in to avoid damage.

Receptacle Options

Suffix

Inlet Options

Suffix

With 2 Auxiliary/Pilot Contacts	Recept # - 972	With 2 Auxiliary/Pilot Contacts	Inlet # - 972
With 3 Auxiliary/Pilot Contacts	Recept # - 973	With 3 Auxiliary/Pilot Contacts	Inlet # - 973
With 4 Auxiliary/Pilot Contacts	Recept # - 974	With 4 Auxiliary/Pilot Contacts	Inlet # - 974
Straight Insertion	Recept # - 352	Self-Ejecting Plug Release	Inlet # - 338
Self-Ejecting Connector Release	Recept # - 354	With No Lockout Hole	Inlet # - A155
Mushroom Pawl	Recept # - 375	For Auxiliary Switch*	Inlet # - NNF
Padlock Pawl	Recept # - 843		
Padlockable Mushroom Pawl	Recept # - 375-843		
Metal Pawl	Recept # - 824		
Closed Lid Configuration	Recept # - NC		
With Auxiliary Switch	Recept # - 270+		

Notes: * Order inlet with P+N+G configuration and receptacle with P+G configuration.

Notes: + Not UL/CSA listed.





! See pages 248-257 for detailed information on these options



Order Example: 480V DSN60 + 2 auxiliary contacts
DSN60 Inlet 3P+G = 63-68043-972

INSTALLATION ACCESSORIES – SIZE 3





Unless indicated otherwise, accessories can be used with either poly or metal plugs and receptacles.

HANDLES

HANDLE w/NPT	Part # Poly	Part # Metal
 1/2"	513P0N05	593P0N05
 3/4"	513P0N07	593P0N07
 1"	513P0N10	593P0N10
 1 1/4"	513P0N12	593P0N12

HANDLE w/CORD GRIP Cable Range	Poly	Metal
 .770 - .875"	713P0DP2	793P0DS1
 .875 - 1.000"	713P0DP3	793P0DS3
 1.000 - 1.125"	713P0EP2	793P0ES2

POLY HANDLE w/Cable Range		
 .39 - 1.18"	513P0D30	Finger draw plates are recommended for easier connector closure on cord to cord assemblies.

POLY HANDLE W/CLAMP & BUSHING w/Cable Range		
 .750 - .875"	713P0S14	
 .875 - 1.000"	713P0S16	
 1.000 - 1.125"	713P0S18	
 1.125 - 1.250"	713P0S20	
 1.250 - 1.375"	713P0S22	

POLY HANDLE W/BUILT IN DRAW GRIPS w/Cable Range		
 .39 - 1.18"	513P0D30473	Makes connector closures easier



For available cord grips, see page 164.

For a guideline of NPT based cable ranges, see DSN30 on pg 29.

ANGLES

POLY ANGLE		
 30°	513M3	



 70°	513M7	
---	-------	--

METAL ANGLE		
 0°	593M0	
 30°	593M3	





 FS/FD Box 30°	793M3FS	* Base measures approximately 4.2" x 2.7". Due to the variation in sizes of FS boxes, please verify that your FS box matches our dimensions, if not call Customer Service for other solutions.
---	---------	--



 70°	593M7	
---	-------	--

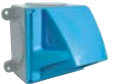



BOXES

POLY CONDUIT ENTRY w/NPT			
 30°	1/2"	513B3N05	* Interior volume with receptacle installed.
 30°	3/4"	513B3N07	
 30°	1"	513B3N10	

POLY WALL BOX w/NPT			
 70°	1/2" - 1 1/4"	513C7000	70° poly boxes are not drilled. Contact customer service if factory drilled is required.
			* Interior volume with receptacle installed.

POLY ANGLE WITH ALUMINUM WALL BOX w/NPT			
 70°	1/2"	713C7N05	* Interior volume with receptacle installed.
 70°	3/4"	713C7N07	
 70°	1"	713C7N10	
 70°	1 1/4"	713C7N12	
 70°	1 1/2"	713C7N15	

METAL BOX w/NPT			
 0°	1/2"	7T1F0N05	
 0°	3/4"	7T1F0N07	
 0°	1"	7T1F0N10	
 0°	1 1/4"	7T1F0N12	

POLY ANGLE WITH METAL BOX w/NPT			
 30°	1/2"	713C3N05	* Interior volume with receptacle installed.
 30°	3/4"	713C3N07	
 30°	1"	713C3N10	
 30°	1 1/4"	713C3N12	

NPT on top or bottom (if rotated). For other NPT configurations, contact customer service.

MISCELLANEOUS ACCESSORIES

FINGER DRAWPLATES		
 61-6A346	Set of Two (2) Recommended for cord to cord assembly applications, for easier connector closure.	

PROTECTIVE CAP		
 61-6A426	For Male Devices Only.	

PADLOCKABLE PLUG CAP		
 61-6A826	For Male Devices Only.	

SPRING-LOADED PADLOCKABLE CAP		
 61-6A226	Metal – For Male Devices Only.	

CORD GRIP with or w/o MESH		
	see pg 164	

RECEPTACLE LOCKING PIN		
 LP-843	Requires Padlockable Pawl option (-843) on receptacle.	

DSN150 Switch-Rated Plugs & Receptacles – 150A

UL/CSA Ratings

- **Max Amperage & Voltage**
150A, 600 VAC
- **Switch-Rating (AC Only)**
Branch Circuit & Motor Circuit Disconnect Switching
- **Horsepower Ratings**

120V	1Ø	7 1/2 hp
240V	1Ø	20 hp
208V	3Ø	30 hp
240V	3Ø	30 hp
480V	3Ø	75 hp
600V	3Ø	75 hp
- **Short Circuit Rating**
100kA Close & Withstand
Testing was performed with 225A RK1 non-time delay Mersen fuses.
10kA Close & Withstand
Testing was performed with 400A RK1 non-time delay Mersen fuses.
- **Environmental Ratings**
Type 4X/IP69k*
*Also meets IP66/IP67 requirements
- **Temperature Range**
Min -40°F/Max 140°F
See pg 271 for temps below -15°F.
- **Wiring Capacity**
Min 4 AWG Max 2/0 AWG
Aux Contacts - Prewired w/14 AWG
- **Certifications**
UL 2682, UL 1682, CSA 182.1

Receptacle (female)

Easy Closing Mechanism



Poly casing opens to 180° while the metal casing opens only 90°.

Inlet (male)

Tabs for latching to closing mechanism

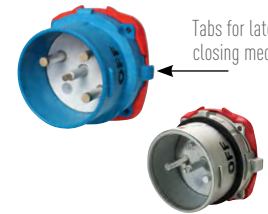

H If you have an existing removable and/or permanently attached drawbar, contact customer service.

! Don't forget to add installation accessories to your order

North American UL/CSA Configurations

Voltage	Polarity	Part #		Part #	
		Poly	Metal	Poly	Metal
120V	1P+N+G	63-94165	69-94165	63-98165	69-98165
120 208V	3P+N+G	63-94167	69-94167	63-98167	69-98167
125V	1P+N+G	63-94075	69-94075	63-98075	69-98075
125 250V	2P+N+G	63-94076	69-94076	63-98076	69-98076
208V	2P+G	63-94162	69-94162	63-98162	69-98162
208V	3P+G	63-94163	69-94163	63-98163	69-98163
250V	2P+G	63-94072	69-94072	63-98072	69-98072
250V	3P+G	63-94073	69-94073	63-98073	69-98073
277V	1P+N+G	63-94045	69-94045	63-98045	69-98045
277 480V	3P+N+G	63-94047	69-94047	63-98047	69-98047
347 600V	3P+N+G	63-94147	69-94147	63-98147	69-98147
480V	2P+G	63-94042	69-94042	63-98042	69-98042
480V	3P+G	63-94043	69-94043	63-98043	69-98043
600V	2P+G	63-94142	69-94142	63-98142	69-98142
600V	3P+G	63-94143	69-94143	63-98143	69-98143

For international configurations and ratings (IEC, CE) visit meltric.com/international-catalog or contact customer service at 800.433.7642.

Main Options



Auxiliary/Pilot Contacts



Mushroom Pawl



Padlock Pawl



Closed Lid Configuration

Recommended for cord applications to keep lid tucked in to avoid damage.

Receptacle Options

Suffix

Inlet Options

Suffix

With 2 Auxiliary/Pilot Contacts	Recept # - 262	With 2 Auxiliary/Pilot Contacts	Inlet # - 262
With 3 Auxiliary/Pilot Contacts	Recept # - 263	With 3 Auxiliary/Pilot Contacts	Inlet # - 263
With 4 Auxiliary/Pilot Contacts	Recept # - 264	With 4 Auxiliary/Pilot Contacts	Inlet # - 264
With 5 Auxiliary/Pilot Contacts	Recept # - 975	With 5 Auxiliary/Pilot Contacts	Inlet # - 975
With 6 Auxiliary/Pilot Contacts	Recept # - 976	With 6 Auxiliary/Pilot Contacts	Inlet # - 976
Straight Insertion	Recept # - 352	Self-Ejecting Plug Release	Inlet # - 338
Self-Ejecting Connector Release	Recept # - 354	With No Lockout Hole	Inlet # - A155
Mushroom Pawl	Recept # - 375	For Auxiliary Switch*	Inlet # - NNF
Padlock Pawl	Recept # - 843		
Padlockable Mushroom Pawl	Recept # - 375-843		
Locking Mushroom Pawl	Recept # - 845		
Metal Pawl (on poly receptacle)	Recept # - 824		
180° Opening Lid (metal only)	Recept # - 180++		
Closed Lid Configuration	Recept # - NC		
With Auxiliary Switch	Recept # - 270+		

Notes: * Order inlet with P+N+G configuration and receptacle with P+G configuration.

! See pages 248-257 for detailed information on these options





Notes: + Not UL/CSA listed.
++ Required when mating to rigid mounted male inlet.





Order Example: 480V DSN150 + 2 auxiliary contacts
DSN150 Poly inlet 3P+G = 63-98043-262

INSTALLATION ACCESSORIES – SIZE 5

Unless indicated otherwise, accessories can be used with either poly or metal plugs and receptacles.

HANDLES

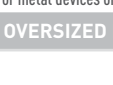
HANDLE w/NPT	Part # Poly	Part # Metal
 3/4"	515P0N07	595P0N07
 1"	515P0N10	595P0N10
 1 1/4"	515P0N12	595P0N12
 1 1/2"	515P0N15	595P0N15
For metal devices only 2"	515P0N20	595P0N20

HANDLE w/CORD GRIP	Cable Range	Poly	Metal
 1.25 - 1.375"	1.25 - 1.375"	-	795P0FS1
 1.270 - 1.470"	1.270 - 1.470"	715P0EP3	-
 1.520 - 1.860"	1.520 - 1.860"	715P0GP2	-
 1.438 - 1.562"	1.438 - 1.562"	-	795P0FS2





For metal devices only

OVERSIZED METAL HANDLE w/NPT			
 3/4"	795P0N07		
1"	795P0N10		
1 1/4"	795P0N12	For available cord grips, see pg 178.	
1 1/2"	795P0N15		
2"	795P0N20	For metal devices only	
2 1/2"	795P0N25		

SANTOPRENE HANDLE w/Cable Range		
 .70 - 1.00"	555P0D25	
IP 66/67 .984 - 1.377"	555P0D35	
1.377 - 1.771"	555P0D45	

POLY HANDLE W/CLAMP & BUSHING w/Cable Range		
 1.250 - 1.375"	715P0S22	
1.438 - 1.562"	715P0S25	
1.562 - 1.688"	715P0S27	
1.688 - 1.812"	715P0S29	

ANGLES

NYLON ANGLE		
 30°	515M3	
METAL ANGLE		
 0°	595M0	
 30°	595M3	
 Oversized 30°	795M3	Mounts on oversize box only. Order with 7T6F0N25XL box. See pg 51.
 70°	595M7	

BOXES

NYLON ANGLE WITH METAL BOX w/NPT			
 30°	1 1/4"	715C3N12	
30°	1 1/2"	715C3N15	* Interior volume with receptacle installed.
30°	2"	715C3N20	
* 108.7 in ³	30°	2 1/2"	715C3N25

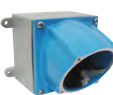
METAL ANGLE WITH METAL BOX w/NPT			
 30°	1 1/4"	795C3N12	
30°	1 1/2"	795C3N15	* Interior volume with receptacle installed.
30°	2"	795C3N20	
* 111.8 in ³	30°	2 1/2"	795C3N25





METAL BOX w/NPT			
 0°	1 1/4"	7T5F0N12	
0°	1 1/2"	7T5F0N15	* Interior volume with receptacle installed.
0°	2"	7T5F0N20	
0°	2 1/2"	7T5F0N25	

NPT on top or bottom (if rotated). For other NPT configurations, contact customer service.

Cable Range	NPT	Cable Range	NPT
.438 - .812	3/4"	.890 - 1.812"	1 1/2"
.660 - 1.000	1"	1.190 - 2.438"	2"
.875 - 1.375"	1 1/4"		

NPT sizes are determined by the cable diameter and third party cord grip.

MISCELLANEOUS ACCESSORIES

	35-9A126	For watertight seal, the male inlet must also be ordered with the 'No Lockout Hole' option (-A155). For Male Devices Only.
	DS9MC	Aluminum - For Male Inlets Only.
	see pgs 178	
	see pg 175	Mount to existing boxes.
	LP-843	Requires Padlockable Pawl option (-843) on receptacle.

DSN SPARE PARTS Male Configuration

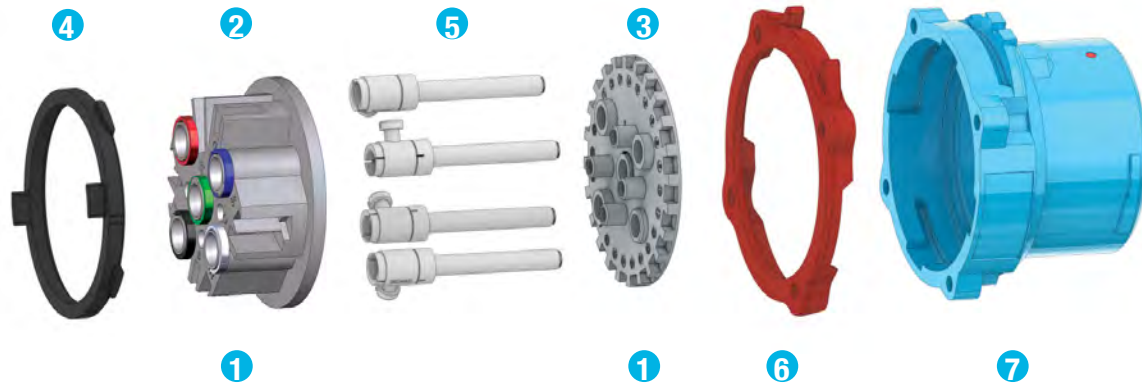

		DSN20 POLY	DSN30 POLY	DSN60 POLY	DSN150 POLY	DSN150 METAL	
1	Plug Interior***	61-1A010*	61-3A010*	61-6A010*	63-9A010*	67-9A010*	
1	Plug Interior with 2 pilots*	-	61-3A310-972*	61-6A310-972*	63-9A310-262	67-9A310-262*	
2	Interior Bottom***	61-1A010-B	61-3A010-B	61-6A010-B	63-9A551	67-9A551	
3	Interior Top***	61-1A010-T*	61-3A010-T*	61-6A010-T*	63-9A010-T*	67-9A010-T*	
4	Polyester Locking Ring	61-1A583	61-3A583	61-6A583	63-9A583	-	
4	Metal Locking Ring	-	-	-	-	67-9A583	
5	Plug Phase Contact (If no aux. contacts)	61-1A011	61-3A011-380	61-6A011	63-9A011	63-9A011	
5	Plug Phase Contact (If plug has aux. contacts)	61-1A011	61-3A011	61-6A011	63-9A011	63-9A011	
5	Plug Ground Contact	61-1A019	61-3A019	61-6A019	63-9A019	63-9A019	
6	Color-Coded Voltage Gasket	125V	61-1AC26	61-3AC26	61-6AC26	31-9AC26	39-2AC26
		208V	61-1AB26	61-3AB26	61-6AB26	31-9AB26	39-2AB26
		250V	61-1AC26	61-3AC26	61-6AC26	31-9AC26	39-2AC26
		480V	61-1AR26	61-3AR26	61-6AR26	31-9AR26	39-2AR26
		600V	61-1AN26	61-3AN26	61-6AN26	31-9AN26	39-2AN26
7	Plug Polyester Casing	61-1A014**	61-3A014**	61-6A014**	63-9A014**	-	
7	Plug Metal Casing	-	-	-	-	67-9A014	

* Voltage and phasing positions must be specified (5th, 6th & 7th digit of Part #) to duplicate your shutter and alignment notches.

** For appropriate labeling on a device, please specify voltage, phasing, and product type.

*** For interiors with pilot contacts, contact Customer Service for part numbers.

+ For interiors with more than 2 pilot contacts, contact Customer Service for part numbers.

DSN SPARE PARTS Female Configuration



		DSN20 POLY	DSN30 POLY	DSN60 POLY	DSN150 POLY	DSN150 METAL	
1	Receptacle Interior***	61-1A020*	61-3A020*	61-6A020*	63-9A020*	67-9A020*	
	Receptacle Interior with 2 pilots*	61-1A020-972	61-3A320-972*	61-6A320-972*	63-9A320-262*	67-9A320-262*	
2	Interior Bottom***	61-1A020-B	61-3A020-B	61-6A020-B	63-9A552	67-9A552	
3	Interior Top***	61-1A020-T*	61-3A020-T*	61-6A020-T*	63-9A020-T*	67-9A020-T*	
4	Polyester Locking Ring	61-1A583	65-3A583	61-6A583	63-9A583	-	
4	Metal Locking Ring	-	-	-	-	67-9A583	
5	Receptacle Phase Contact (If no aux. contacts)	61-1A021	61-3A021-380	61-6A021	63-9A021	63-9A021	
5	Receptacle Phase Contact (If plug has aux. contacts)	61-1A021	61-3A021	61-6A021	63-9A021	63-9A021	
5	Receptacle Ground Contact	61-1A029	61-3A029	61-6A029	63-9A029	67-9A029	
6	Color-Coded Voltage Gasket	125V	61-1AC26	61-3AC26	61-6AC26	31-9AC26	31-9AC26
		208V	61-1AB26	61-3AB26	61-6AB26	31-9AB26	31-9AB26
		250V	61-1AC26	61-3AC26	61-6AC26	31-9AC26	31-9AC26
		480V	61-1AR26	61-3AR26	61-6AR26	31-9AR26	31-9AR26
		600V	61-1AN26	61-3AN26	61-6AN26	31-9AN26	31-9AN26
7	Receptacle Polyester Casing	61-1A024**	61-3A024**	61-6A024**	63-9A024**	-	
7	Receptacle Metal Casing	-	-	-	-	67-9A024	
8	Lid Replacement Kit Polyester	61-1A125	61-3A125	61-6A125	63-9A125	-	
8	Lid Replacement Kit Metal	-	-	-	-	67-9A925	
9	Pawl Replacement Kit Polyester	61-1A824	61-6A824	61-6A824	61-9A824	-	
9	Pawl Replacement Kit Metal	69-1A824	69-6A924	69-6A924	69-9A924	67-9A824	

* Voltage and phasing positions must be specified (5th, 6th & 7th digit of Part #) to duplicate your shutter and alignment notches.

** For appropriate labeling on a device, please specify voltage, phasing, and product type.

*** For interiors with pilot contacts, contact Customer Service for part numbers.

* For interiors with more than 2 pilot contacts, contact Customer Service for part numbers.

DSN DIMENSIONS – Provided in inches

Dimensions are for reference only and may change depending on accessories used. For precise dimensions contact MELTRIC Engineering.

Plug

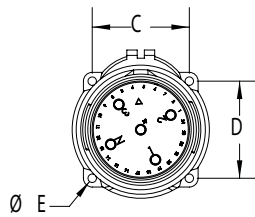
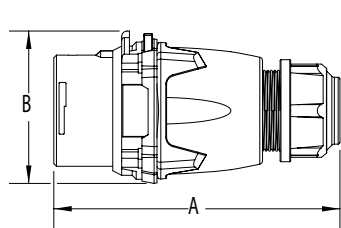

Inlet

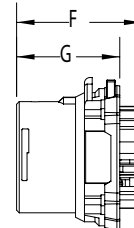

PRODUCT	A	B	C	D	øE	F	G
DSN20	5.28	2.40	1.65	1.65	0.17	2.46	1.87
DSN30	5.75	2.91	1.89	1.89	0.18	2.56	1.97
DSN60	6.30	3.46	2.17	2.17	0.19	2.80	2.21
DSN150	8.33	4.59	3.20	3.20	0.24	4.14	3.04

Connector

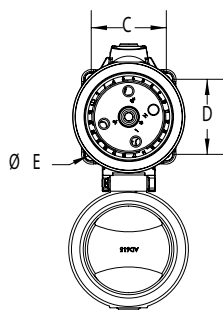
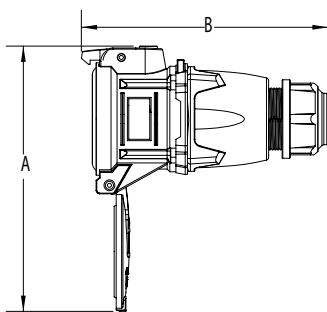

Receptacle

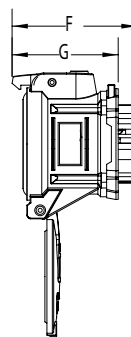

Extended Draw bars

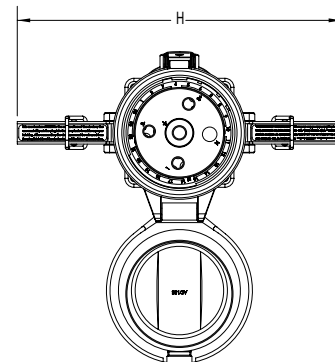

PRODUCT	A	B	C	D	øE	F	G	H
DSN20	5.26	5.6	1.65	1.65	0.19	3.15	2.10	N/A
DSN30	7.05	6.93	1.89	1.89	0.18	3.53	2.88	N/A
DSN60	7.74	7.22	2.17	2.17	0.20	3.64	3.09	N/A
DSN150	11.04	10.02	3.20	3.20	0.23	5.71	4.74	11.52

Box /30° Angle/ Receptacle/Plug

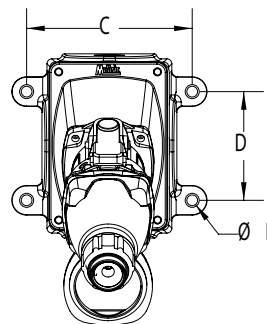
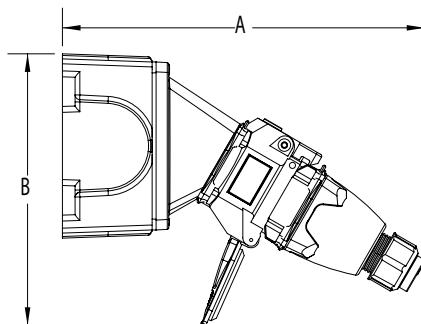

PRODUCT	A	B	C	D	øE
DSN20	7.80	7.25	4.19	2.75	0.27
DSN30	9.85	7.60	4.19	2.75	0.27
DSN60	10.48	8.20	4.19	2.75	0.27
DSN150	16.06	10.33	6.75	4.25	0.31



30° Angle/Receptacle/Plug

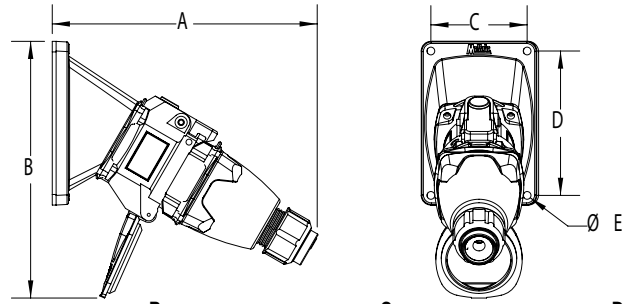

PRODUCT	A	B	C	D	øE
DSN20	7.80	7.10	2.50	3.75	0.18
DSN30	9.85	8.50	2.50	3.75	0.22
DSN60	10.48	9.02	2.50	3.75	0.22
DSN150	16.06	12.05	4.83	4.83	0.28

70° Wall Box/Receptacle

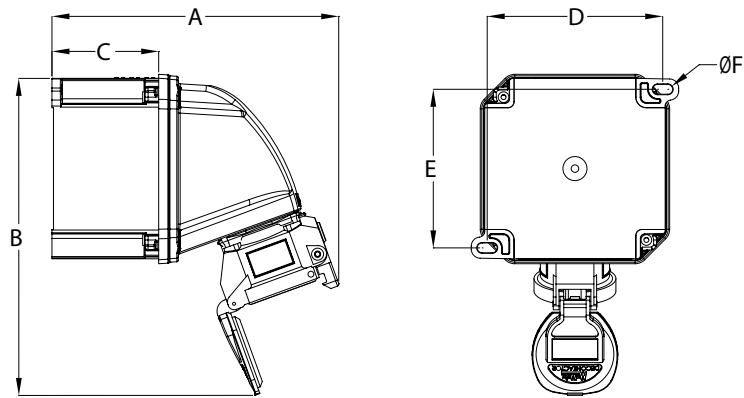

PRODUCT	A	B	C	D	E	øF
DSN20	7.51	8.30	2.80	4.60	4.15	0.26
DSN30	7.93	9.51	2.80	4.60	4.15	0.26
DSN60*	8.91	11.55	2.80	6.17	5.73	0.26

* Box has 4 mounting feet

Plug/Connector

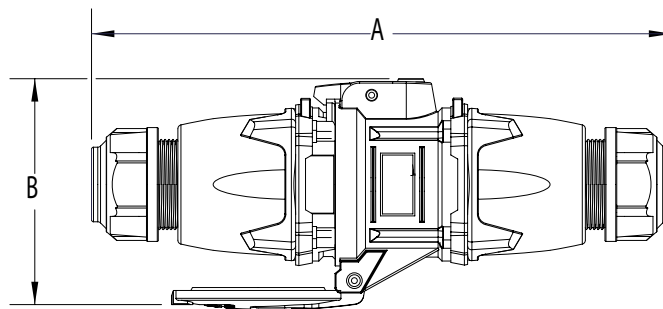

PRODUCT	A	B
DSN20	9.09	3.50
DSN30/DSN24	10.43	4.57
DSN60/DSN37	11.26	4.80
DSN150	19.53	8.03



DS Switch-Rated plug and receptacle



Main Advantages

- ▶ Switch & Hp rated (AC only)
- ▶ 65 kA to 100 kA short circuit rated*
- ▶ Up to 6 auxiliary contacts
- ▶ Amperage ratings up to 200A
- ▶ Metal or Poly construction

* See note under General Ratings on the next page.



Highlighted Advantage



Simplify Compliance to
NFPA 70E & CSA Z462
see pgs 18-19 for
more information



- | | | | |
|------------------------|-------|---------------|-------|
| ▶ Features and Ratings | p. 39 | ▶ DS100 | p. 48 |
| ▶ DS20 | p. 40 | ▶ DS200 | p. 50 |
| ▶ DS30 | p. 42 | ▶ Spare parts | p. 52 |
| ▶ DS60 | p. 44 | ▶ Dimensions | p. 54 |
| ▶ DS100C | p. 46 | | |

PRODUCT FEATURES

DECONTACTOR™ Technology

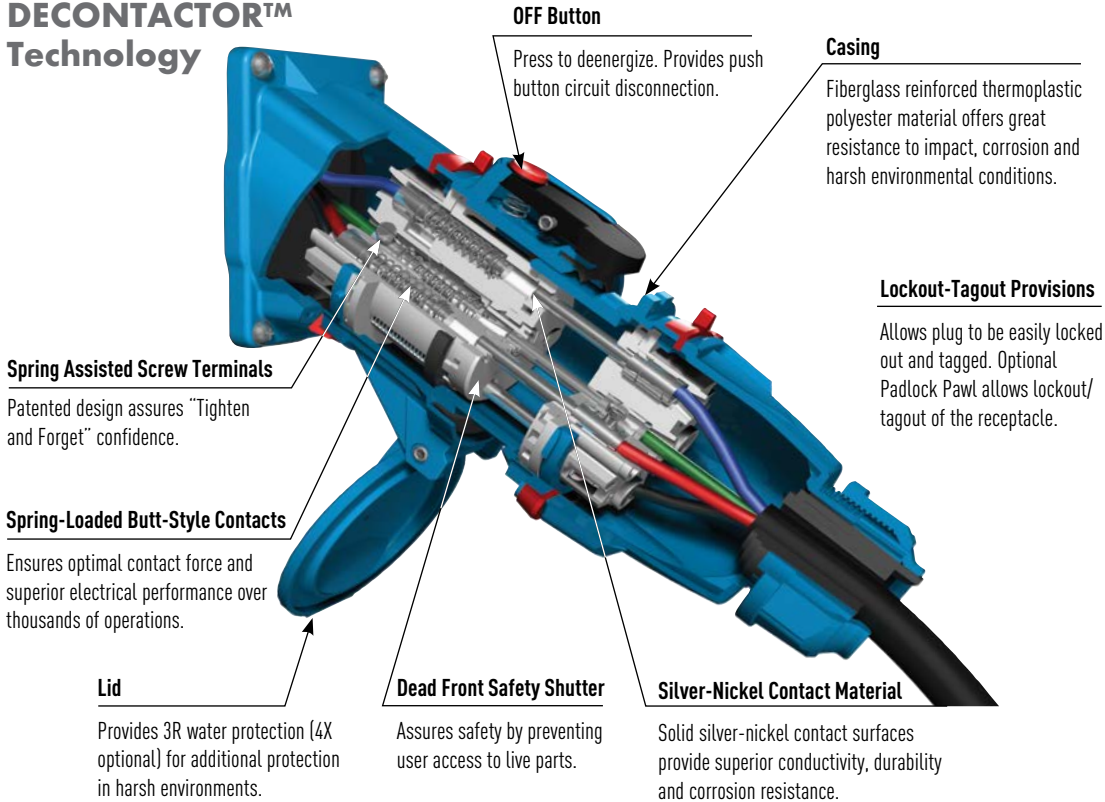

General Ratings

Amperage	20 to 200A
Voltage	600 VAC
Frequency	50-400 Hz
Horsepower	3/4 to 100 hp
Short-Circuit (Make & Withstand)	10kA to 100kA*
Environmental	Type 3R, Type 4X optional
Temperature	min -40°F/max 140°F

* DS20, 30, 60 & 100C are rated 100kA. DS200 is rated 10kA. Testing was performed with RK1 current limiting fuses sized at 400% of the highest full load motor ampacity associated with the devices hp rating.

* DS100 is rated 65kA. Testing was performed with RK5 time delay fuses sized at 100% of the devices rated ampacity.

Listings

Category	UL	CSA	IEC
Plugs and Receptacles	UL 1682	C22.2 No. 182.1	60309-1
Branch Circuit Disconnect Switching (AC only)	UL Subject 2682 (Performance tests from UL 98)	UL Subject 2682	60947-3, AC22, AC23
Motor Circuit Disconnect Switching (AC only)	UL Subject 2682 (Performance tests from UL 98)	UL Subject 2682	60947-3, AC22, AC23

CE ratings available upon request.

Highlighted Feature

Typical Device Labels

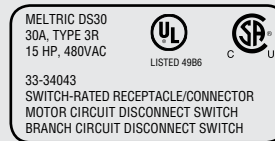

Meltric DS Series Switch-Rated devices are UL & CSA rated for "motor circuit" and "branch circuit" disconnect switching - up to 100 hp and up to 200A.

Operating Instructions



When the plug and receptacle are latched together, the circuit is connected.



Pressing the pawl breaks the connection and opens the circuit. The plug is ejected to its rest position; The contacts are now dead.



Rotating the 'dead' plug 30° counterclockwise closes the safety shutter and frees the plug to be withdrawn from the receptacle.



The plug and the receptacle are separated. The safety shutter prevents access to live parts.

5 To reconnect, insert plug into receptacle, rotate 30° clockwise, and apply insertion force.

DS20 Switch-Rated Plugs & Receptacles – 20A

UL/CSA Ratings

- **Max Amperage & Voltage**
20A, 600 VAC
- **Switch-Rating (AC Only)**
Branch Circuit & Motor Circuit Disconnect Switching
- **Horsepower Ratings**

120V	1Ø	3/4 hp
208V	3Ø	3 hp
240V	3Ø	5 hp
480V	3Ø	7 1/2 hp
600V	3Ø	10 hp
- **Short Circuit Rating**
100kA Close & Withstand
Tested with RK1 current limiting fuses sized at 400% of the highest full load motor ampacity.
- **Environmental Ratings**
Type 3R (Standard)
Type 4X (Optional)
- **Temperature Range**
Min -40°F/Max 140°F
See pg 271 for temps below -15°F.
- **Wiring Capacity**
Min 14 AWG Max 8 AWG
Aux Contact - Max 14 AWG
Based on THHN wire sizes
- **Certifications**
UL 2682, UL 1682, CSA 182.1

Receptacle (female)



Inlet (male)



! Don't forget to add installation accessories to your order

North American UL/CSA Configurations

Voltage	Polarity	Part # Poly	Part # Poly
120V	1P+N+G	33-14165	33-18165
120 208V	3P+N+G	33-14167	33-18167
125V	1P+N+G	33-14075	33-18075
125 250V	2P+N+G	33-14076	33-18076
208V	2P+G	33-14162	33-18162
208V	3P+G	33-14163	33-18163
250V	2P+G	33-14072	33-18072
250V	3P+G	33-14073	33-18073
277V	1P+N+G	33-14045	33-18045
277 480V	3P+N+G	33-14047	33-18047
347 600V	3P+N+G	33-14147	33-18147
480V	2P+G	33-14042	33-18042
480V	3P+G	33-14043	33-18043
600V	2P+G	33-14142	33-18142
600V	3P+G	33-14143	33-18143

For international configurations and ratings (IEC, CE) visit meltric.com/international-catalog or contact customer service at 800.433.7642.

Main Options



Auxiliary/Pilot Contacts



Mushroom Pawl



Padlock Pawl



Closed Lid Configuration

Recommended for cord applications to keep lid tucked in to avoid damage.

Receptacle Options

Suffix

Inlet Options

Suffix

With 2 Auxiliary/Pilot Contacts	Recept # - 972	With 2 Auxiliary/Pilot Contacts	Inlet # - 972
Type 4X & closed lid configuration	Recept # - 4X	Type 4X watertightness	Inlet # - 4X
Straight Insertion	Recept # - 352	Self-Ejecting Plug Release	Inlet # - 338
Self-Ejecting Connector Release	Recept # - 354	With No Lockout Hole	Inlet # - A155
Mushroom Pawl	Recept # - 375	For Auxiliary Switch*	Inlet # - NNF
Padlock Pawl	Recept # - 843		
Padlockable Mushroom Pawl	Recept # - 375-843		
Locking Mushroom Pawl	Recept # - 845		
Metal Pawl (on poly receptacle)	Recept # - 824		
Closed Lid Configuration	Recept # - NC		
With Auxiliary Switch	Recept # - 270+		

Notes: * Order inlet with P+N+G configuration and receptacle with P+G configuration.

Notes: + Not UL/CSA listed.

! See pages 248-257 for detailed information on these options

Order Example: 208V DS20 + 2 auxiliary contacts
DS20 Poly inlet 2P+G = 33-18162-972

INSTALLATION ACCESSORIES – SIZE 2

Unless indicated otherwise, accessories can be used with either poly or metal plugs and receptacles.

HANDLES

HANDLE w/NPT	Part # Poly	Part # Metal
 1/2"	512P0N05	592P0N05
3/4"	512P0N07	592P0N07
1"	512P0N10	592P0N10
1 1/4"	512P0N12	-

HANDLE w/CORD GRIP Cable Range	Poly	Metal
 .438 - .500"	712P0BP3	792P0BS3
.500 - .562"	712P0BP4	792P0BS4
.562 - .625"	712P0BP5	792P0BS5
.625 - .750"	712P0CP4	792P0CS4

NYLON HANDLE w/Cable Range	Part #
 .20 - .82"	512P0D21





POLY HANDLE W/CLAMP & BUSHING w/Cable Range	Part #
 .750 - .875"	712P0S14
.875 - 1.000"	712P0S16
1.000 - 1.125"	712P0S18
1.125 - 1.250"	712P0S20
1.250 - 1.375"	712P0S22

For available cord grips, see pg 178.

Cable Range	NPT	Cable Range	NPT
.312 - .625	1/2"	.660 - 1.000	1"
.438 - .812	3/4"	.875 - 1.375"	1 1/4"

NPT sizes are determined by the cable diameter and third party cord grip.

ANGLES

NYLON ANGLE	Part #
 30°	512M3
METAL ANGLE	Part #
 0°	592M0
 30°	592M3
 FS/FD Box 30°	792M3FS

* Base measures approximately 4.2" x 2.7". Due to the variation in sizes of FS boxes, please verify that your FS box matches our dimensions, if not call Customer Service for other solutions.

BOXES

POLY CONDUIT ENTRY w/NPT	Part #
 30° 1/2"	512B3N05
30° 3/4"	512B3N07

* 7.0 in³

POLY WALL BOX w/NPT	Part #
 70° 1/2" - 1 1/4"	512C7000

* 82.0 in³

70° poly boxes are not drilled. Contact customer service if factory drilling is required.

* Interior volume with receptacle installed.

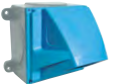
POLY ANGLE WITH ALUMINUM WALL BOX w/NPT	Part #
 70° 1/2"	712C7N05
70° 3/4"	712C7N07
70° 1"	712C7N10
70° 1 1/4"	712C7N12
70° 1 1/2"	712C7N15

* 75.0 in³

* Interior volume with receptacle installed.

METAL BOX w/NPT	Part #
 0° 1/2"	7T1F0N05
0° 3/4"	7T1F0N07
0° 1"	7T1F0N10
0° 1 1/4"	7T1F0N12

METAL BOX WITH NYLON ANGLE w/NPT	Part #
 30° 1/2"	712C3N05
30° 3/4"	712C3N07
30° 1"	712C3N10
30° 1 1/4"	712C3N12

* 28.7 in³

* Interior volume with receptacle installed.

NPT on top or bottom (if rotated). For other NPT configurations, contact customer service.

MISCELLANEOUS ACCESSORIES

FINGER DRAWPLATES	Part #	Description
	61-3A346	Set of Two (2) Recommended for cord to cord assembly applications, for easier connector closure.

PROTECTIVE CAP	Part #	Description
	31-1A426	For Male Devices Only.

PADLOCKABLE PLUG CAP	Part #	Description
	DS1PC	For Male Devices Only.

INLET SPRING-LOADED CAP	Part #
	31-1A226

EASY RETROFIT ADAPTER PLATES	Part #	Description
	see pg 175	Mount to existing boxes.

RECEPTACLE LOCKING PIN	Part #	Description
	LP-843	Requires Padlockable Pawl option (-843) on receptacle.

DS30 Switch-Rated Plugs & Receptacles – 30A

UL/CSA Ratings

- Max Amperage & Voltage**
30A, 600 VAC
- Switch-Rating (AC Only)**
Branch Circuit & Motor Circuit
Disconnect Switching
- Horsepower Ratings**

120V	1Ø	1 1/2 hp
240V	1Ø	3 hp
208V	3Ø	5 hp
240V	3Ø	5 hp
480V	3Ø	15 hp
600V	3Ø	15 hp
- Short Circuit Rating**
100kA Close & Withstand
Tested with RK1 current limiting fuses sized at 400% of the highest full load motor ampacity.
- Environmental Ratings**
Type 3R (Standard)
Type 4X (Optional)
- Temperature Range**
Min -40°F/Max 140°F
See pg 271 for temps below -15°F.
- Wiring Capacity**
Min 14 AWG Max 4 AWG
Aux Contacts - Max 14 AWG
Based on THHN wire sizes
- Certifications**
UL 2682, UL 1682, CSA 182.1

Receptacle (female)



Inlet (male)



! Don't forget to add installation accessories to your order

North American UL/CSA Configurations

Voltage	Polarity	Part # Poly	Part # Poly
120V	1P+N+G	33-34165	33-38165
120 208V	3P+N+G	33-34167	33-38167
125V	1P+N+G	33-34075	33-38075
125 250V	2P+N+G	33-34076	33-38076
208V	2P+G	33-34162	33-38162
208V	3P+G	33-34163	33-38163
250V	2P+G	33-34072	33-38072
250V	3P+G	33-34073	33-38073
277V	1P+N+G	33-34045	33-38045
277 480V	3P+N+G	33-34047	33-38047
347 600V	3P+N+G	33-34147	33-38147
480V	2P+G	33-34042	33-38042
480V	3P+G	33-34043	33-38043
600V	2P+G	33-34142	33-38142
600V	3P+G	33-34143	33-38143

For international configurations and ratings (IEC, CE) visit meltric.com/international-catalog or contact customer service at 800.433.7642.

Main Options



Auxiliary/Pilot Contacts



Mushroom Pawl



Padlock Pawl



Closed Lid Configuration

Recommended for cord applications to keep lid tucked in to avoid damage.

Receptacle Options

Suffix

Inlet Options

Suffix

With 2 Auxiliary/Pilot Contacts	Recept # - 972	With 2 Auxiliary/Pilot Contacts	Inlet # - 972
With 3 Auxiliary/Pilot Contacts	Recept # - 973	With 3 Auxiliary/Pilot Contacts	Inlet # - 973
With 4 Auxiliary/Pilot Contacts	Recept # - 974	With 4 Auxiliary/Pilot Contacts	Inlet # - 974
Type 4X & closed lid configuration	Recept # - 4X	Type 4X watertightness	Inlet # - 4X
Straight Insertion	Recept # - 352	Self-Ejecting Plug Release	Inlet # - 338
Self-Ejecting Connector Release	Recept # - 354	With No Lockout Hole	Inlet # - A155
Mushroom Pawl	Recept # - 375	For Auxiliary Switch*	Inlet # - NNF
Padlock Pawl	Recept # - 843	Notes: * Order inlet with P+N+G configuration and receptacle with P+G configuration.	
Padlockable Mushroom Pawl	Recept # - 375-843		
Locking Mushroom Pawl	Recept # - 845		
Metal Pawl (on poly receptacle)	Recept # - 824		
Closed Lid Configuration	Recept # - NC		
With Auxiliary Switch	Recept # - 270+		

Notes: + Not UL/CSA listed.

Order Example: 480V DS30 + 2 auxiliary contacts





DS30 Poly inlet 3P+G = 33-38043-972





! See pages 248-257 for detailed information on these options

INSTALLATION ACCESSORIES – SIZE 3





Unless indicated otherwise, accessories can be used with either poly or metal plugs and receptacles.

HANDLES

HANDLE w/NPT	Part # Poly	Part # Metal
 1/2"	513P0N05	593P0N05
 3/4"	513P0N07	593P0N07
 1"	513P0N10	593P0N10
 1 1/4"	513P0N12	593P0N12

HANDLE w/CORD GRIP Cable Range	Poly	Metal
 .625 - .750"	713P0CP4	793P0CS4
 .770 - .875"	713P0DP2	793P0DS1
 .875 - 1.000"	713P0DP3	793P0DS3
 1.000 - 1.125"	713P0EP2	793P0ES2





NYLON HANDLE w/Cable Range		
 .39 - 1.18"	513P0D30	Finger draw plates are recommended for easier connector closure on cord to cord assemblies.

POLY HANDLE W/CLAMP & BUSHING w/Cable Range		
 .750 - .875"	713P0S14	
 .875 - 1.000"	713P0S16	
 1.000 - 1.125"	713P0S18	
 1.125 - 1.250"	713P0S20	
 1.250 - 1.375"	713P0S22	



POLY HANDLE W/BUILT IN DRAW GRIPS w/Cable Range		
 .39 - 1.18"	513P0D30473	Makes connector closures easier.

For available cord grips, see pg 178.
For a guideline of NPT based cable ranges, see DS20 on pg 41.





ANGLES





NYLON ANGLE		
 30°	513M3	
METAL ANGLE		
 0°	593M0	
 30°	593M3	
 FS/FD Box 30°	793M3FS	* Base measures approximately 4.2" x 2.7". Due to the variation in sizes of FS boxes, please verify that your FS box matches our dimensions, if not call Customer Service for other solutions.
 70°	593M7	





BOXES

POLY CONDUIT ENTRY w/NPT			
 30°	1/2"	513B3N05	For poly devices only
 30°	3/4"	513B3N07	
 * 13.5 in ³	1"	513B3N10	* Interior volume with receptacle installed.

POLY WALL BOX w/NPT			
 70°	1/2" - 1 1/4"	513C7000	70° poly boxes are not drilled. Contact customer service if factory drilling is required.
 * 179.41 in ³			* Interior volume with receptacle installed.

POLY ANGLE WITH ALUMINUM WALL BOX w/NPT			
 70°	1/2"	713C7N05	
 70°	3/4"	713C7N07	
 70°	1"	713C7N10	* Interior volume with receptacle installed.
 * 170.0 in ³	1 1/4"	713C7N12	
 70°	1 1/2"	713C7N15	

METAL BOX w/NPT			
 0°	1/2"	7T1F0N05	
 0°	3/4"	7T1F0N07	
 0°	1"	7T1F0N10	
 0°	1 1/4"	7T1F0N12	

METAL BOX WITH NYLON ANGLE w/NPT			
 30°	1/2"	713C3N05	
 30°	3/4"	713C3N07	* Interior volume with receptacle installed.
 30°	1"	713C3N10	
 * 29.6 in ³	1 1/4"	713C3N12	

NPT on top or bottom (if rotated). For other NPT configurations, contact customer service.

MISCELLANEOUS ACCESSORIES

FINGER DRAWPLATES		
 61-6A346	Set of Two (2) Recommended for cord to cord assembly applications, for easier connector closure.	

PROTECTIVE CAP		
 31-3A426	For Male Devices Only.	

PADLOCKABLE PLUG CAP		
 DS3PC	For Male Devices Only.	

INLET SPRING-LOADED CAP		
 31-3A226		

EASY RETROFIT ADAPTER PLATES		
 see pg 175	Mount to existing boxes.	

RECEPTACLE LOCKING PIN		
 LP-843	Requires Padlockable Pawl option (-843) on receptacle.	

DS60 Switch-Rated Plugs & Receptacles – 60A

UL/CSA Ratings

- Max Amperage & Voltage**
60A, 600 VAC
- Switch-Rating (AC Only)**
Branch Circuit & Motor Circuit Disconnect Switching
- Horsepower Ratings**

120V	1Ø	3 hp
240V	1Ø	5 hp
208V	3Ø	10 hp
240V	3Ø	10 hp
480V	3Ø	25 hp
600V	3Ø	25 hp
- Short Circuit Rating**
100kA Close & Withstand
Tested with RK1 current limiting fuses sized at 400% of the highest full load motor ampacity.
- Environmental Ratings**
Type 3R (Standard)
Type 4X (Optional)
- Temperature Range**
Min -40°F/Max 140°F
See pg 271 for temps below -15°F.
- Wiring Capacity**
Min 10 AWG Max 2 AWG
Aux Contacts - Max 14 AWG
Based on THHN wire sizes
- Certifications**
UL 2682, UL 1682, CSA 182.1

Receptacle (female)



Inlet (male)



! Don't forget to add installation accessories to your order

North American UL/CSA Configurations

Voltage	Polarity	Part #		Part #	
		Poly	Metal	Poly	Metal
120V	1P+N+G	33-64165	37-64165	33-68165	37-68165
120 208V	3P+N+G	33-64167	37-64167	33-68167	37-68167
125V	1P+N+G	33-64075	37-64075	33-68075	37-68075
125 250V	2P+N+G	33-64076	37-64076	33-68076	37-68076
208V	2P+G	33-64162	37-64162	33-68162	37-68162
208V	3P+G	33-64163	37-64163	33-68163	37-68163
250V	2P+G	33-64072	37-64072	33-68072	37-68072
250V	3P+G	33-64073	37-64073	33-68073	37-68073
277V	1P+N+G	33-64045	37-64045	33-68045	37-68045
277 480V	3P+N+G	33-64047	37-64047	33-68047	37-68047
347 600V	3P+N+G	33-64147	37-64147	33-68147	37-68147
480V	2P+G	33-64042	37-64042	33-68042	37-68042
480V	3P+G	33-64043	37-64043	33-68043	37-68043
600V	2P+G	33-64142	37-64142	33-68142	37-68142
600V	3P+G	33-64143	37-64143	33-68143	37-68143

For international configurations and ratings (IEC, CE) visit meltric.com/international-catalog or contact customer service at 800.433.7642.

Main Options



Auxiliary/Pilot Contacts



Mushroom Pawl



Padlock Pawl



Closed Lid Configuration
Recommended for cord applications to keep lid tucked in to avoid damage.

Receptacle Options

Suffix

Inlet Options

Suffix

With 2 Auxiliary/Pilot Contacts	Recept # - 972	With 2 Auxiliary/Pilot Contacts	Inlet # - 972
With 3 Auxiliary/Pilot Contacts	Recept # - 263	With 3 Auxiliary/Pilot Contacts	Inlet # - 263
With 4 Auxiliary/Pilot Contacts	Recept # - 264	With 4 Auxiliary/Pilot Contacts	Inlet # - 264
Type 4X & closed lid configuration	Recept # - 4X	Type 4X watertightness	Inlet # - 4X
Straight Insertion	Recept # - 352	Self-Ejecting Plug Release	Inlet # - 338
Self-Ejecting Connector Release	Recept # - 354	With No Lockout Hole	Inlet # - A155
Mushroom Pawl	Recept # - 375	For Auxiliary Switch*	Inlet # - NNF
Padlock Pawl	Recept # - 843		
Padlockable Mushroom Pawl	Recept # - 375-843		
Locking Mushroom Pawl	Recept # - 845		
Metal Pawl (on poly receptacle)	Recept # - 824		
Closed Lid Configuration	Recept # - NC		
With Auxiliary Switch	Recept # - 270+		
180° Opening Lid (metal only)	Recept # - 180++		

Notes: * Order inlet with P+N+G configuration and receptacle with P+G configuration.

! See pages 248-257 for detailed information on these options





Notes: * Not UL/CSA listed.
++ Required when mating to rigid mounted male inlet.





Order Example: 480V DS60 + 2 auxiliary contacts
DS60 Poly inlet 3P+G = 33-68043-972

INSTALLATION ACCESSORIES – SIZE 4

Unless indicated otherwise, accessories can be used with either poly or metal plugs and receptacles.





HANDLES

HANDLE w/NPT	Part # Poly	Part # Metal
 1/2"	514P0N05	594P0N05
 3/4"	514P0N07	594P0N07
 1"	514P0N10	594P0N10
 1 1/4"	514P0N12	594P0N12
For metal devices only 1 1/2"	514P0N15	594P0N15

HANDLE w/CORD GRIP w/Cable Range	Poly	Metal
 .750 - .875"	714P0DP2	794P0DS1
 .875 - 1.000"	714P0DP3	794P0DS3
 1.000 - 1.125"	714P0EP2	794P0ES2
 1.250 - 1.375"	-	794P0ES4

For metal devices only

POLY HANDLE w/Cable Range	Part #
 .51 - 1.38"	514P0D35

POLY HANDLE W/CLAMP & BUSHING w/Cable Range	Part #
 1.250 - 1.375"	714P0S22
 1.438 - 1.562"	714P0S25
 1.562 - 1.688"	714P0S27
 1.688 - 1.812"	714P0S29

POLY HANDLE W/BUILT IN DRAW GRIPS w/Cable Range	Part #	Description
 .51 - 1.38"	514P0D35473	Makes connector closures easier.





For available cord grips, see page 164.

Cable Range	NPT	Cable Range	NPT
.312 - .625"	1/2"	.875 - 1.375"	1 1/4"
.438 - .812"	3/4"	.890 - 1.812"	1 1/2"
.660 - 1.000"	1"		

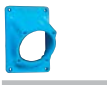

NPT sizes are determined by the cable diameter and third party cord grip.

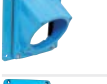
ANGLES

POLY ANGLE	Part #
 30°	514M3

METAL ANGLE	Part #	Description
 0°	594M0	
 30°	594M3	
 30°	794M3L	
 Oversized 30°	794M3	Mounts on oversize box only. Order with 715F-0Nxx. See pg 49.
 70°	594M7	



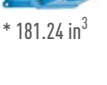

BOXES

POLY CONDUIT ENTRY w/NPT	Part #	Description
 30w 1/2"	514B3N05	For poly devices only
 30° 3/4"	514B3N07	
 30° 1"	514B3N10	* Interior volume with receptacle installed.
 30° 1 1/4"	514B3N12	

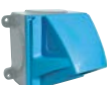

* 27.7 in³





POLY WALL BOX w/NPT	Part #	Description
 70° 1/2 - 2"	514C7000	70° poly boxes are not drilled. Contact customer service if factory drilling is required. * Interior volume with receptacle installed.

* 181.24 in³

POLY ANGLE WITH ALUMINUM WALL BOX w/NPT	Part #	Description
 70° 1/2"	714C7N05	
 70° 3/4"	714C7N07	
 70° 1"	714C7N10	* Interior volume with receptacle installed.
 70° 1 1/4"	714C7N12	
 70° 1 1/2"	714C7N15	

* 170.0 in³

METAL BOX w/NPT	Part #
 0° 1"	7T4F0N10
 0° 1 1/4"	7T4F0N12
 0° 1 1/2"	7T4F0N15
 0° 2"	7T4F0N20



POLY ANGLE WITH METAL BOX w/NPT	Part #	Description
 30° 1"	714C3N10	For metal angle, replace "71" prefix with "79".
 30° 1 1/4"	714C3N12	
 30° 1 1/2"	714C3N15	
 30° 2"	714C3N20	* Interior volume with receptacle installed.



* 61.0 in³ Poly Angle
* 59.4 in³ Metal Angle

MISCELLANEOUS ACCESSORIES

FINGER DRAWPLATES	Part #	Description
	31-6A346	Set of Two (2) Recommended for cord to cord assembly applications, for easier connector closure.

PROTECTIVE CAP	Part #	Description
	31-6A426	For Male Devices Only.

PADLOCKABLE PLUG CAP	Part #	Description
	DS6PC	Poly - For Male Devices Only.
	DS6MC	Aluminum - For Male Devices Only.

SPRING-LOADED PADLOCKABLE CAP	Part #	Description
	31-6A226	Metal - For Male Poly Devices Only.
	39-6A226	Metal - For Male Metal Devices Only.

DS100C Switch-Rated Plugs & Receptacles – 100A

UL/CSA Ratings

- **Max Amperage & Voltage**
100A, 600 VAC
- **Switch-Ratings (AC Only)**
Branch Circuit & Motor Circuit
Disconnect Switching
- **Horsepower Ratings**

120V	1Ø	5 hp
240V	1Ø	10 hp
208V	3Ø	20 hp
240V	3Ø	20 hp
480V	3Ø	50 hp
600V	3Ø	50 hp
- **Short Circuit Rating**
100kA Close & Withstand
Tested with RK1 current limiting fuses sized at 400% of the highest full load motor ampacity.
- **Environmental Ratings**
Type 3R (Standard)
Type 4X (Optional)
- **Temperature Range**
Min -40°F/Max 140°F
See pg 271 for temps below -15°F.
- **Wiring Capacity**
Min 10 AWG Max 2 AWG
Aux Contacts - Max 14 AWG
Based on THHN wire sizes
- **Certifications**
UL 2682, UL 1682, CSA 182.1

Receptacle (female)



Inlet (male)



! Don't forget to add installation accessories to your order

North American UL/CSA Configurations

Voltage	Polarity	Part #		Part #	
		Poly	Metal	Poly	Metal
120V	1P+N+G	33-64235-C-K16	37-64235-C-K16	33-68235-C-K16	37-68235-C-K16
120 208V	3P+N+G	33-64237-C-K16	37-64237-C-K16	33-68237-C-K16	37-68237-C-K16
125V	1P+N+G	33-64175-C-K07	37-64175-C-K07	33-68175-C-K07	37-68175-C-K07
125 250V	2P+N+G	33-64176-C-K07	37-64176-C-K07	33-68176-C-K07	37-68176-C-K07
208V	2P+G	33-64232-C-K16	37-64232-C-K16	33-68232-C-K16	37-68232-C-K16
208V	3P+G	33-64233-C-K16	37-64233-C-K16	33-68233-C-K16	37-68233-C-K16
250V	2P+G	33-64172-C-K07	37-64172-C-K07	33-68172-C-K07	37-68172-C-K07
250V	3P+G	33-64173-C-K07	37-64173-C-K07	33-68173-C-K07	37-68173-C-K07
277V	1P+N+G	33-64245-C-K04	37-64245-C-K04	33-68245-C-K04	37-68245-C-K04
277 480V	3P+N+G	33-64247-C-K04	37-64247-C-K04	33-68247-C-K04	37-68247-C-K04
347 600V	3P+N+G	33-64187-C-K14	37-64187-C-K14	33-68187-C-K14	37-68187-C-K14
480V	2P+G	33-64242-C-K04	37-64242-C-K04	33-68242-C-K04	37-68242-C-K04
480V	3P+G	33-64243-C-K04	37-64243-C-K04	33-68243-C-K04	37-68243-C-K04
600V	2P+G	33-64182-C-K14	37-64182-C-K14	33-68182-C-K14	37-68182-C-K14
600V	3P+G	33-64183-C-K14	37-64183-C-K14	33-68183-C-K14	37-68183-C-K14

For international configurations and ratings (IEC, CE) visit meltric.com/international-catalog or contact customer service at 800.433.7642.

Main Options



Auxiliary/Pilot Contacts



Mushroom Pawl



Padlock Pawl



Closed Lid Configuration
Recommended for cord applications to keep lid tucked in to avoid damage.

Receptacle Options

Suffix

Inlet Options

Suffix

With 2 Auxiliary/Pilot Contacts	Recept # - 972	With 2 Auxiliary/Pilot Contacts	Inlet # - 972
With 3 Auxiliary/Pilot Contacts	Recept # - 263	With 3 Auxiliary/Pilot Contacts	Inlet # - 263
With 4 Auxiliary/Pilot Contacts	Recept # - 264	With 4 Auxiliary/Pilot Contacts	Inlet # - 264
Type 4X & closed lid configuration	Recept # - 4X	Type 4X watertightness	Inlet # - 4X
Straight Insertion	Recept # - 352	Self-Ejecting Plug Release	Inlet # - 338
Self-Ejecting Connector Release	Recept # - 354	With No Lockout Hole	Inlet # - A155
Mushroom Pawl	Recept # - 375	For Auxiliary Switch*	Inlet # - NNF
Padlock Pawl	Recept # - 843		
Padlockable Mushroom Pawl	Recept # - 375-843		
Locking Mushroom Pawl	Recept # - 845		
Metal Pawl (on poly receptacle)	Recept # - 824		
Closed Lid Configuration	Recept # - NC		
With Auxiliary Switch	Recept # - 270+		
180° Opening Lid (metal only)	Recept # - 180++		

Notes: * Order inlet with P+N+G configuration and receptacle with P+G configuration.

! See pages 248-257 for detailed information on these options





Notes: * Not UL/CSA listed.
++ Required when mating to rigid mounted male inlet.

Order Example: 480V DS100C + 2 auxiliary contacts
DS100C Poly inlet 3P+G = 33-68243-C-K04-972





INSTALLATION ACCESSORIES – SIZE 4

Unless indicated otherwise, accessories can be used with either poly or metal plugs and receptacles.

HANDLES





HANDLE w/NPT	Part # Poly	Part # Metal
 1/2"	514P0N05	594P0N05
 3/4"	514P0N07	594P0N07
 1"	514P0N10	594P0N10
 1 1/4"	514P0N12	594P0N12
 1 1/2"	514P0N15	594P0N15

For metal devices only

HANDLE w/CORD GRIP Cable Range	Poly	Metal
 1.000 - 1.125	714P0EP2	-
 1.270 - 1.470"	714P0EP3	-
 1.250 - 1.375"	-	794P0ES4
 1.438 - 1.562"	-	794P0FS2
 1.562 - 1.688"	-	794P0FS3

For metal devices only

NYLON HANDLE w/Cable Range	Part #
 .51 - 1.38"	514P0D35

POLY HANDLE W/CLAMP & BUSHING w/Cable Range	Part #
 1.250 - 1.375"	714P0S22
 1.438 - 1.562"	714P0S25
 1.562 - 1.688"	714P0S27
 1.688 - 1.812"	714P0S29

POLY HANDLE W/BUILT IN DRAW GRIPS w/Cable Range	Part #	Notes
 .51 - 1.38"	514P0D35473	Makes connector closures easier

For available cord grips, see pg 178.

Cable Range	NPT	Cable Range	NPT
.312 - .625	1/2"	.875 - 1.375"	1 1/4"
.438 - .812	3/4"	.890 - 1.812"	1 1/2"
.660 - 1.000	1"		

NPT sizes are determined by the cable diameter and third party cord grip.

ANGLES

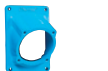
NYLON ANGLE	Part #
 30°	514M3

METAL ANGLE	Part #
 0°	594M0



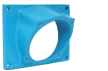

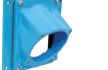
 30°	594M3
---	-------

 30°	794M3L
---	--------





 Oversized 30°	794M3	Mounts on oversize box only. Order with 7T5F0Nxx. See pg 49.
---	-------	--



 70°	594M7
---	-------



BOXES

POLY CONDUIT ENTRY w/NPT	Part #	Notes
 30° 1/2"	514B3N05	For poly devices only * Interior volume with receptacle installed.
 30° 3/4"	514B3N07	
 30° 1"	514B3N10	
 30° 1 1/4"	514B3N12	

POLY WALL BOX w/NPT	Part #	Notes
 70° 1/2" - 2"	514C7000	70° poly boxes are not drilled. Contact customer service if factory drilling is required. * Interior volume with receptacle installed.

POLY ANGLE WITH ALUMINUM WALL BOX w/NPT	Part #	Notes
 70° 1/2"	714C7N05	* Interior volume with receptacle installed.
 70° 3/4"	714C7N07	
 70° 1"	714C7N10	
 70° 1 1/4"	714C7N12	
 70° 1 1/2"	714C7N15	

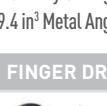
METAL BOX w/NPT	Part #
 0° 1"	7T4F0N10
 0° 1 1/4"	7T4F0N12
 0° 1 1/2"	7T4F0N15
 0° 2"	7T4F0N20

METAL BOX WITH NYLON ANGLE w/NPT	Part #	Notes
 30° 1"	714C3N10	For metal angle, replace "71" prefix with "79". * Interior volume with receptacle installed.
 30° 1 1/4"	714C3N12	
 30° 1 1/2"	714C3N15	
 30° 2"	714C3N20	

MISCELLANEOUS ACCESSORIES

FINGER DRAWPLATES	Part #	Notes
 31-6A346	31-6A346	Set of Two (2) Recommended for cord to cord assembly applications, for easier connector closure.

PROTECTIVE CAP	Part #	Notes
 31-6A426	31-6A426	For Male Devices Only.

PADLOCKABLE PLUG CAP	Part #	Notes
 DS6PC	DS6PC	Poly - For Male Devices Only.

PADLOCKABLE PLUG CAP	Part #	Notes
 DS6MC	DS6MC	Aluminum - For Male Devices Only.

INLET SPRING-LOADED CAP	Part #
 31-6A226	31-6A226

EASY RETROFIT ADAPTER PLATES	Part #	Notes
 see pg 175	see pg 175	Mount to existing boxes.

RECEPTACLE LOCKING PIN	Part #	Notes
 LP-843	LP-843	Requires Padlockable Pawl option (-843) on receptacle.

DS100 Switch-Rated Plugs & Receptacles – 100A

UL/CSA Ratings

- **Max Amperage & Voltage**
100A, 600 VAC
- **Switch-Rating (AC Only)**
Branch Circuit & Motor Circuit Disconnect Switching
- **Horsepower Ratings**

120V	1Ø	3 hp
240V	1Ø	7 1/2 hp
208V	3Ø	10 hp
240V	3Ø	10 hp
480V	3Ø	30 hp
- **Short Circuit Rating**
65kA Close & Withstand
Testing was performed with RK5 time delay fuses sized at 100% of the devices rated ampacity. Alternate testing was performed with 175A RK1 non-time delay Mersen fuses.
- **Environmental Ratings**
Type 4X (Poly Standard)
Type 3R (Metal Standard)
Type 4X (Metal Optional)
- **Temperature Range**
Min -40°F/Max 140°F
See pg 271 for temps below -15°F.
- **Wiring Capacity**
Min 4 AWG Max 2/0 AWG
Aux Contacts - Max 14 AWG
Based on THHN wire sizes
- **Certifications**
UL 2682, UL 1682, CSA 182.1

Receptacle (female)

Inlet (male)



North American UL/CSA Configurations

Voltage	Polarity	Part #		Part #	
		Poly	Metal	Poly	Metal
120V	1P+N+G	33-94165	37-94165	33-98165	37-98165
120 208V	3P+N+G	33-94167	37-94167	33-98167	37-98167
125V	1P+N+G	33-94075	37-94075	33-98075	37-98075
125 250V	2P+N+G	33-94076	37-94076	33-98076	37-98076
208V	2P+G	33-94162	37-94162	33-98162	37-98162
208V	3P+G	33-94163	37-94163	33-98163	37-98163
250V	2P+G	33-94072	37-94072	33-98072	37-98072
250V	3P+G	33-94073	37-94073	33-98073	37-98073
277V	1P+N+G	33-94045	37-94045	33-98045	37-98045
277 480V	3P+N+G	33-94047	37-94047	33-98047	37-98047
347 600V	3P+N+G	33-94147	37-94147	33-98147	37-98147
480V	2P+G	33-94042	37-94042	33-98042	37-98042
480V	3P+G	33-94043	37-94043	33-98043	37-98043
600V	2P+G	33-94142	37-94142	33-98142	37-98142
600V	3P+G	33-94143	37-94143	33-98143	37-98143

For international configurations and ratings (IEC, CE) visit meltric.com/international-catalog or contact customer service at 800.433.7642.

Main Options

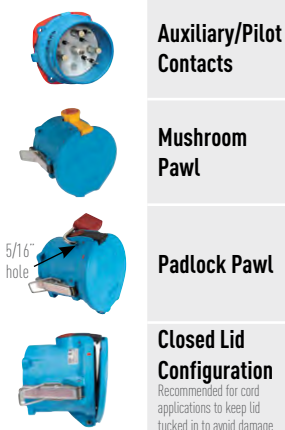

Receptacle Options

Suffix

Inlet Options

Suffix

With 2 Auxiliary/Pilot Contacts	Recept # - 262	With 2 Auxiliary/Pilot Contacts	Inlet # - 262
With 3 Auxiliary/Pilot Contacts	Recept # - 263	With 3 Auxiliary/Pilot Contacts	Inlet # - 263
With 4 Auxiliary/Pilot Contacts	Recept # - 264	With 4 Auxiliary/Pilot Contacts	Inlet # - 264
With 5 Auxiliary/Pilot Contacts	Recept # - 975	With 5 Auxiliary/Pilot Contacts	Inlet # - 975
With 6 Auxiliary/Pilot Contacts	Recept # - 976	With 6 Auxiliary/Pilot Contacts	Inlet # - 976
Type 4X & closed lid configuration	Recept # - 4Xⁱ	Type 4X watertightness	Inlet # - 4Xⁱ
Straight Insertion	Recept # - 352	Self-Ejecting Plug Release	Inlet # - 338
Self-Ejecting Connector Release	Recept # - 354	With No Lockout Hole	Inlet # - A155
Mushroom Pawl	Recept # - 375	For Auxiliary Switch*	Inlet # - NNF
Padlock Pawl	Recept # - 843		
Padlockable Mushroom Pawl	Recept # - 375-843		
Locking Mushroom Pawl	Recept # - 845		
Metal Pawl (on poly receptacle)	Recept # - 824		
180° Opening Lid (metal only)	Recept # - 180++		
Closed Lid Configuration	Recept # - NC		
With Auxiliary Switch	Recept # - 270+		

Notes: * Order inlet with P+N+G configuration and receptacle with P+G configuration.

! See pages 248-257 for detailed information on these options





Notes: + Not UL/CSA listed.
++ Required when mating to rigid mounted male inlet.
i Metal devices only.





Order Example: 480V DS100 + 2 auxiliary contacts
DS100 Poly inlet 3P+G = 33-98043-972

INSTALLATION ACCESSORIES – SIZE 5

Unless indicated otherwise, accessories can be used with either poly or metal plugs and receptacles.

HANDLES

HANDLE w/NPT	Part # Poly	Part # Metal
 3/4"	515P0N07	595P0N07
 1"	515P0N10	595P0N10
 1 1/4"	515P0N12	595P0N12
 1 1/2"	515P0N15	595P0N15
For metal devices only 2"	515P0N20	595P0N20





HANDLE w/CORD GRIP	Cable Range	Poly	Metal
	1.270 - 1.470"	715P0EP3	-
	1.250 - 1.375"	-	795P0ES4
	1.438 - 1.562"	-	795P0FS2
	1.562 - 1.688"	-	795P0FS3
For metal devices only	1.520 - 1.860"	715P0GP2	-

OVERSIZED METAL HANDLE w/NPT			
	3/4"	795P0N07	
	1"	795P0N10	
	1 1/4"	795P0N12	For available cord grips, see pg 178.
	1 1/2"	795P0N15	
	2"	795P0N20	For metal devices only.
	2 1/2"	795P0N25	

SANTOPRENE HANDLE w/Cable Range		
	.70 - 1.00"	555P0D25
	.984 - 1.377"	555P0D35
IP 66/67	1.377 - 1.771"	555P0D45

POLY HANDLE W/CLAMP & BUSHING w/Cable Range		
	1.250 - 1.375"	715P0S22
	1.438 - 1.562"	715P0S25
	1.562 - 1.688"	715P0S27
	1.688 - 1.812"	715P0S29

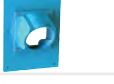
ANGLES

NYLON ANGLE			
	30°	515M3	
METAL ANGLE			
	0°	595M0	
	30°	595M3	
	Oversized 30°	795M3	Mounts on oversize box only. Order with 7T6F0N25XL. See pg 51.
	70°	595M7	

BOXES

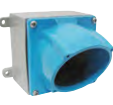
NYLON ANGLE WITH METAL BOX w/NPT			
	30°	1 1/4"	715C3N12
	30°	1 1/2"	715C3N15
	30°	2"	715C3N20
* 108.7 in ³	30°	2 1/2"	715C3N25

* Interior volume with receptacle installed.

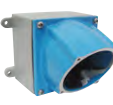
METAL ANGLE WITH METAL BOX w/NPT			
	30°	1 1/4"	795C3N12
	30°	1 1/2"	795C3N15
	30°	2"	795C3N20
* 111.8 in ³	30°	2 1/2"	795C3N25

* Interior volume with receptacle installed.

METAL BOX w/NPT			
	0°	1 1/4"	7T5F0N12
	0°	1 1/2"	7T5F0N15
	0°	2"	7T5F0N20
	0°	2 1/2"	7T5F0N25

NPT on top or bottom (if rotated). For other NPT configurations, contact customer service.

i

Cable Range	NPT	Cable Range	NPT
.438 - .812	3/4"	.890 - 1.812"	1 1/2"
.660 - 1.000	1"	1.190 - 2.438"	2"
.875 - 1.375"	1 1/4"		

NPT sizes are determined by the cable diameter and third party cord grip.

MISCELLANEOUS ACCESSORIES

PROTECTIVE CAP		
	35-9A126	For watertight seal, the male inlet must also be ordered with the 'No Lockout Hole' option (-A155). For Male Devices Only.

PADLOCKABLE PLUG CAP		
	DS9MC	Aluminum – For Male Devices Only.

CORD GRIP with MESH		
	see pg 178	

EASY RETROFIT ADAPTER PLATES		
	see pg 175	Mount to existing boxes.

RECEPTACLE LOCKING PIN		
	LP-843	Requires Padlockable Pawl option (-843) on receptacle.

DS200 Switch-Rated Plugs & Receptacles – 200A

UL/CSA Ratings

- **Max Amperage & Voltage**
200A, 600 VAC
- **Switch-Rating (AC Only)**
Branch Circuit & Motor Circuit Disconnect Switching
- **Horsepower Ratings**

208V	3Ø	40 hp
240V	3Ø	40 hp
480V	3Ø	100 hp
600V	3Ø	100 hp
- **Short Circuit Rating**
10kA Close & Withstand
Tested with RK1 current limiting fuses sized at 400% of the highest full load-motor ampacity
- **Environmental Ratings**
Type 3R (Standard)
Type 4X (Optional)
- **Temperature Range**
Min -40°F/Max 140°F
See pg 271 for temps below -15°F.
- **Wiring Capacity**
Min 4 AWG Max 4/0 AWG
Aux Contacts - Max 14 AWG
Based on THHN wire sizes
- **Certifications**
UL 2682, UL 1682, CSA 182.1

Receptacle (female)

Easy Closing Mechanism



If you have an existing removable and/or permanently attached drawbar, contact customer service.



Don't forget to add installation accessories to your order



Standard DS200 lid opens to 90°

Inlet (male)



Tabs for latching to closing mechanism

North American UL/CSA Configurations

Voltage	Polarity	Part # Metal	Part # Metal
120V	1P+N+G	37-24165	37-28165
120 208V	3P+N+G	37-24167	37-28167
125V	1P+N+G	37-24075	37-28075
125 250V	2P+N+G	37-24076	37-28076
208V	2P+G	37-24162	37-28162
208V	3P+G	37-24163	37-28163
250V	2P+G	37-24072	37-28072
250V	3P+G	37-24073	37-28073
277V	1P+N+G	37-24045	37-28045
277 480V	3P+N+G	37-24047	37-28047
347 600V	3P+N+G	37-24147	37-28147
480V	2P+G	37-24042	37-28042
480V	3P+G	37-24043	37-28043
600V	2P+G	37-24142	37-28142
600V	3P+G	37-24143	37-28143

For international configurations and ratings (IEC, CE) visit meltric.com/international-catalog or contact customer service at 800.433.7642.

Main Options



Auxiliary/Pilot Contacts



Mushroom Pawl



Padlock Pawl



Closed Lid Configuration
Recommended for cord applications to keep lid tucked in to avoid damage.

Receptacle Options

Suffix

Inlet Options

Suffix

With 2 Auxiliary/Pilot Contacts	Recept # - 972*	With 2 Auxiliary/Pilot Contacts	Inlet # - 972*
With 4 Auxiliary/Pilot Contacts	Recept # - 174+	With 4 Auxiliary/Pilot Contacts	Inlet # - 174+
With 6 Auxiliary/Pilot Contacts	Recept # - 976+	With 6 Auxiliary/Pilot Contacts	Inlet # - 976+
Type 4X & closed lid configuration	Recept # - 4X	Type 4X watertightness	Inlet # - 4X
Straight Insertion	Recept # - A188+++	Self-Ejecting Plug Release	Inlet # - 338-A188+++
Mushroom Pawl	Recept # - 375	For Auxiliary Switch**	Inlet # - NNF
Padlock Pawl	Recept # - 843	With No Lockout Hole	Inlet # - A155
Padlockable Mushroom Pawl	Recept # - 375-843		
Locking Mushroom Pawl	Recept # - 845		
180° Opening Lid	Recept # - 180++		
Closed Lid Configuration	Recept # - NC		
With Auxiliary Switch	Recept # - 270+++		

Notes: ** Order inlet with P+N+G configuration and receptacle with P+G configuration.

- Notes:**
- * Customers needing to maintain compatibility with old style -172 auxiliary contacts should use a -172 suffix.
 - + This option not available with N contact.
 - ++ Required when mating to rigid mounted male inlet.
 - +++ Not UL/CSA listed.



Order Example: 480V DS200 + 2 auxiliary contacts
DS200 Metal inlet 3P+G = 37-28043-972



See pages 248-257 for detailed information on these options

INSTALLATION ACCESSORIES – SIZE 6

Unless indicated otherwise, accessories can be used with either poly or metal plugs and receptacles.

HANDLES

HANDLE w/NPT	Part # Poly	Part # Metal
 1"	-	596P0N10
 1 1/4"	-	596P0N12
1 1/2"	516P0N15	596P0N15
2"	516P0N20	596P0N20
2 1/2"	516P0N25	596P0N25
For metal devices only 3"	-	596P0N30

HANDLE w/CORD GRIP	Cable Range	Poly	Metal
	1.688 - 1.812"	-	796P0GS1
	1.812 - 1.938"	-	796P0GS2
	1.850 - 2.190"	716P0GP3	-
	1.938 - 2.062"	-	796P0GS3
	2.062 - 2.188"	-	796P0GS4
	2.188 - 2.312"	-	796P0GS5
	2.312 - 2.438"	-	796P0GS6
	2.437 - 2.625"	-	796P0KS1
	2.625 - 2.812"	-	796P0KS2

OVERSIZED METAL HANDLE w/NPT	Part # Poly	Part # Metal
 1 1/2"	597P0N15	
2"	597P0N20	For available cord grips, see pg 178.
2 1/2"	597P0N25	
3"	597P0N30	For metal devices only.

SANTOPRENE HANDLE w/Cable Range	Part # Poly	Part # Metal
 .984 - 1.377"	556P0D35	
1.377 - 1.771"	556P0D45	
IP 66/67 1.771 - 1.929"	556P0D49	

For available cord grips, see pg 178.

BOXES

BOX ANGLE WITH METAL BOX w/NPT	Part #
 60° 1 1/2"	796C6N15
60° 2"	796C6N20
* 248.4 in ³ 60° 2 1/2"	796C6N25

* Interior volume with receptacle installed.

METAL BOX w/NPT	Part #
 0° 1 1/2"	7T6F0N15
0° 2"	7T6F0N20
0° 2 1/2"	7T6F0N25

* Interior volume with receptacle installed.





OVERSIZED METAL BOX w/NPT	Part #
 0° 2 1/2"	7T6F0N25XL

NPT on top or bottom (if rotated). For other NPT configurations, contact customer service.

Cable Range	NPT	Cable Range	NPT
.660 - 1.000	1"	1.190 - 2.438"	2"
.875 - 1.375"	1 1/4"	2.062 - 2.438"	2 1/2"
.890 - 1.812"	1 1/2"	2.438 - 2.812"	3"

NPT sizes are determined by the cable diameter and third party cord grip.

ANGLES

METAL ANGLE	Part # Poly	Part # Metal
 0°		596M0
 Oversized 45°	796M4	Mounts on oversize metal box only. Order with 7T6F0N25XL.
 60°		596M6
 Extended 60°		597M6

MISCELLANEOUS ACCESSORIES

PROTECTIVE CAP	Part #	Description
	35-2A126	For watertight seal, the male inlet must also be ordered with the 'No Lockout Hole' option (-A155). For Male Devices Only.

PADLOCKABLE PLUG CAP	Part #	Description
	DS2MC	Aluminum – For Male Devices Only.

CORD GRIP with MESH	Part #
	see pg 178

EASY RETROFIT ADAPTER PLATES	Part #	Description
	see pg 175	Mount to existing boxes.

RECEPTACLE LOCKING PIN	Part #	Description
	LP-843	Requires Padlockable Pawl option (-843) on receptacle.

DS SPARE PARTS Male Configuration

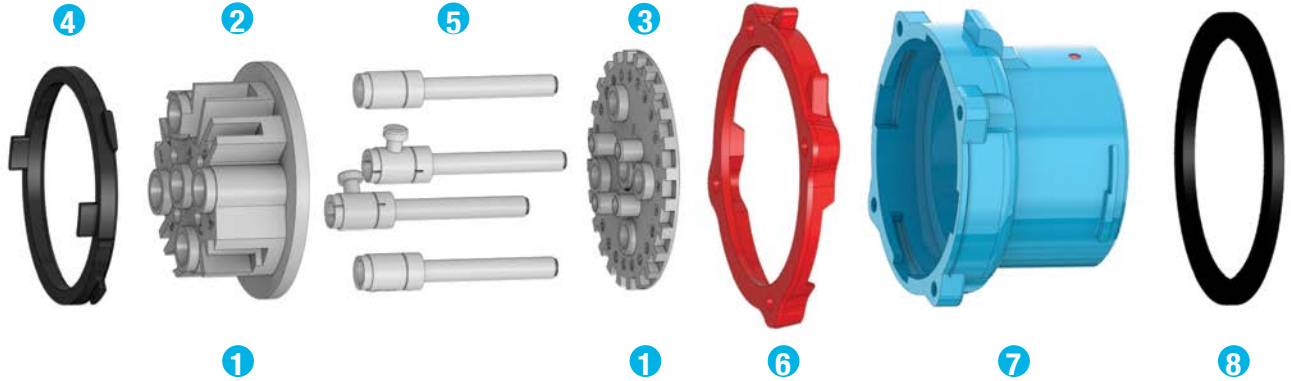

	DS20 POLY	DS30 POLY	DS60 POLY	DS60 METAL	DS100C POLY	DS100C METAL	DS100 POLY	DS100 METAL	DS200 METAL
1 Plug Interior***	31-1A010*	31-3A010*	31-6A010*	31-6A010*	31-6A010-C*	31-6A010-C*	61-9A010*	69-9A010*	39-2A010*
1 Plug Interior w/Ground Contacts***	-	-	-	39-6A110*	-	39-6A110-C*	-	69-9A110*	39-2A110*
1 Plug Interior with 2 Pilots+	31-1A310-972*	31-3A310-972*	31-6A310-972*	31-6A310-972*	31-6A310-C-972*	31-6A310-C-972*	61-9A310-262*	61-9A310-262*	39-2A310-972*
2 Interior Bottom***	31-1A010-B	31-3A010-B	31-6A010-B	31-6A010-B	31-6A010-C-B	31-6A010-C-B	61-9A551	69-9A551	39-2A010-B
3 Interior Top***	31-1A010-T*	31-3A010-T*	31-6A010-T*	31-6A010-T*	31-6A010-C-T*	31-6A010-C-T*	61-9A010-T*	69-9A010-T*	39-2A010-T*
4 Polyester Locking Ring	31-1A583	31-3A583	31-6A583	-	31-6A583	-	31-9A583	-	-
4 Metal Locking Ring	-	-	-	39-6A583	-	39-6A583	-	39-9A583	39-2A583
5 Plug Phase Contact (If no aux. contacts)	31-1A011-380	31-3A011-380	31-6A011	31-6A011	31-6A011-C	31-6A011-C	61-9A011	61-9A011	39-2A011
5 Plug Phase Contact (If plug has aux. contacts)	31-1A011	31-3A011-380	31-6A011	31-6A011	31-6A011-C	31-6A011-C	61-9A011	61-9A011	39-2A011
5 Plug Ground Contact	31-1A019	31-3A019	31-6A019	31-6A019	31-6A019-C	39-6A019-C	61-9A019	69-9A019	39-2A019
6 Color-Coded Voltage Gasket	125V	31-1AC26	31-3AC26	31-6AC26	31-6AC26	31-6AC26	31-9AC26	31-9AC26	39-2AC26
	208V	31-1AB26	31-3AB26	31-6AB26	31-6AB26	31-6AB26	31-9AB26	31-9AB26	39-2AB26
	250V	31-1AC26	31-3AC26	31-6AC26	31-6AC26	31-6AC26	31-9AC26	31-9AC26	39-2AC26
	480V	31-1AR26	31-3AR26	31-6AR26	31-6AR26	31-6AR26	31-9AR26	31-9AR26	39-2AR26
	600V	31-1AN26	31-3AN26	31-6AN26	31-6AN26	31-6AN26	31-9AN26	31-9AN26	39-2AN26
7 Plug Polyester Casing	31-1A014**	31-3A014**	31-6A014**	-	31-6A014-C**	-	61-9A014**	-	-
7 Plug Metal Casing	-	-	-	39-6A014**	-	39-6A014-C**	-	39-9A014**	39-2A014**
8 Type 4X Gasket	31-1A056	31-3A056	31-6A066	39-6A066	31-6A066	39-6A066	-	31-9A066	39-2A056

* Voltage and phasing positions must be specified (5th, 6th & 7th digit of Part #) to duplicate your shutter and alignment notches.

** For appropriate labeling on a device, please specify voltage, phasing, and product type.

*** For interiors with pilot contacts, contact Customer Service for part numbers.

+ For interiors with more than 2 pilot contacts, contact Customer Service for part numbers.

DS SPARE PARTS Female Configuration



	DS20 POLY	DS30 POLY	DS60 POLY	DS60 METAL	DS100C POLY	DS100C METAL	DS100 POLY	DS100 METAL	DS200 METAL
1 Receptacle Interior***	31-1A020*	31-3A020*	31-6A020*	31-6A020*	31-6A020-C*	31-6A020-C*	61-9A020*	69-9A020*	39-2A020*
1 Recept Interior w/Ground Contacts***	-	-	-	39-6A220*	-	39-6A220-C*	-	69-9A220*	39-2A220*
1 Receptacle Interior with 2 Pilots+	31-1A320-972*	31-3A320-972*	31-6A320-972*	31-6A320-972*	31-6A320-C-972*	31-1A320-C-972*	61-9A320-262*	61-9A320-262*	39-2A320-972*
2 Interior Bottom***	31-1A020-B	31-3A020-B	31-6A020-B	31-6A020-B	31-6A020-C-B	31-6A020-C-B	61-9A552	69-9A552	39-2A020-B
3 Interior Top***	31-1A020-T*	31-3A020-T*	31-6A020-T*	31-6A020-T*	31-6A020-C-T*	31-6A020-C-T*	61-9A020-T*	69-9A020-T*	39-2A020-T*
4 Polyester Locking Ring	31-1A583	31-3A583	31-6A583	-	31-6A583	-	31-9A583	-	-
4 Metal Locking Ring	-	-	-	39-6A583	-	39-6A583	-	39-9A583	39-2A583
5 Recept Phase Contact (If no aux. contacts)	31-1A021-380	31-3A021-380	31-6A021	31-6A021	31-6A021-C	31-6A021-C	61-9A021	61-9A021	39-2A021
5 Recept Phase Contact (If plug has aux. contacts)	31-1A021	31-3A021-380	31-6A021	31-6A021	31-6A021-C	31-6A021-C	61-9A021	61-9A021	39-2A021
5 Recept Ground Contact	31-1A029	31-3A029	31-6A029	39-6A029	31-6A029-C	39-6A029-C	61-9A029	69-9A029	39-2A029
6 Color-Coded Voltage Gasket	125V	31-1AC26	31-3AC26	31-6AC26	31-6AC26	31-6AC26	31-9AC26	31-9AC26	39-2AC26
	208V	31-1AB26	31-3AB26	31-6AB26	31-6AB26	31-6AB26	31-9AB26	31-9AB26	39-2AB26
	250V	31-1AC26	31-3AC26	31-6AC26	31-6AC26	31-6AC26	31-9AC26	31-9AC26	39-2AC26
	480V	31-1AR26	31-3AR26	31-6AR26	31-6AR26	31-6AR26	31-9AR26	31-9AR26	39-2AR26
	600V	31-1AN26	31-3AN26	31-6AN26	31-6AN26	31-6AN26	31-9AN26	31-9AN26	39-2AN26
7 Receptacle Polyester Casing w/Lid	31-1A024**	31-3A024**	31-6A024**	-	31-6A024-C**	-	61-9A024**	-	-
7 Receptacle Metal Casing w/Lid	-	-	-	39-6A024**	-	39-6A024-C**	-	39-9A024**	39-2A024**
8 Lid Replacement Kit Polyester	31-1A125	31-3A125	31-6A425	-	31-6A425	-	61-9A125	-	-
8 Lid Replacement Kit Metal	-	-	-	39-6A925	-	39-6A925	-	39-9A925	39-2A925
9 Pawl Replacement Kit Polyester	31-1A824	31-3A824	31-6A824	-	31-6A824	-	61-9A824	-	-
9 Pawl Replacement Kit Metal	39-1A824	39-3A824	39-6A824	39-6A824	39-6A824	39-6A824	69-9A924	39-9A824	39-2A824

** For appropriate labeling on a device, please specify voltage, phasing, and product type.

*** For interiors with more than 2 pilot contacts, contact Customer Service for part numbers.

* For interiors with more than 2 pilot contacts, contact Customer Service for part numbers.

For replacement parts contact customer service at 800.433.7642

DS DIMENSIONS – Provided in inches

Dimensions are for reference only and may change depending on accessories used. For precise dimensions contact MELTRIC Engineering.

Plug

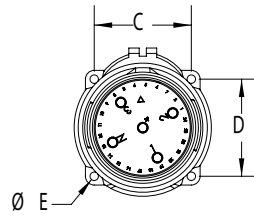
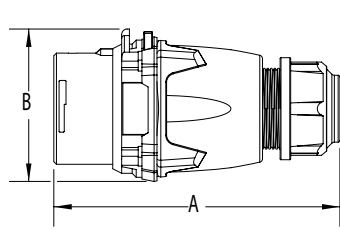

Inlet

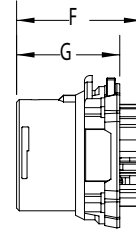

PRODUCT	A	B	C	D	øE	F	G
DS20	5.72	2.79	1.89	1.89	0.20	2.28	1.86
DS30	6.15	3.23	2.17	2.17	0.20	2.93	2.07
DS60/DS100c/DS7c	6.70	3.77	2.59	2.59	0.24	3.42	2.38
DS100	8.33	4.59	3.20	3.20	0.24	4.14	3.04
DS200	10.3	5.67	3.86	3.86	0.26	4.66	3.20

Connector

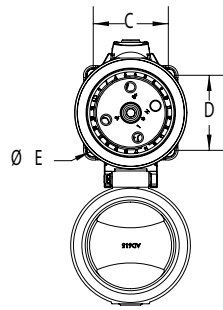
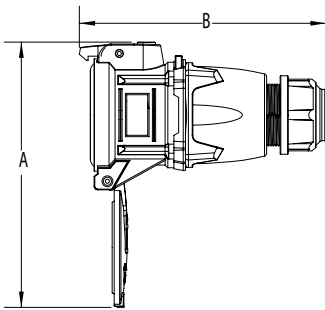

Receptacle

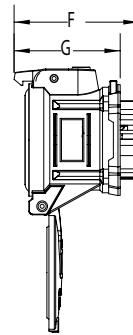

Extended Draw bars

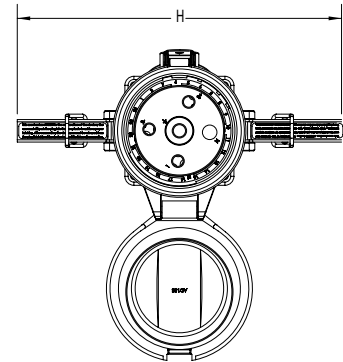

PRODUCT	A	B	C	D	øE	F	G	H
DS20	6.32	6.38	1.89	1.89	0.20	3.30	2.60	N/A
DS30	7.16	6.93	2.17	2.17	0.20	3.73	2.87	N/A
DS60/DS100c/DS7c	8.46	7.75	2.59	2.59	0.22	4.53	3.37	N/A
DS100	11.04	10.02	3.20	3.20	0.23	5.71	4.74	11.52
DS200	11.54	10.87	3.86	3.86	0.26	6.21	4.75	12.07

Box/30° Angle/ Receptacle/Plug

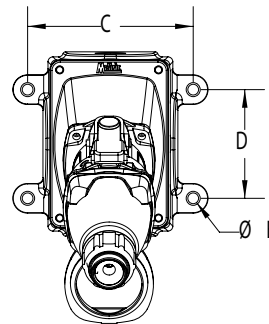
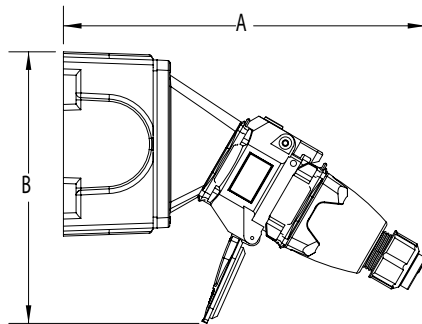

PRODUCT	A	B	C	D	øE
DS20	9.84	7.29	4.19	2.75	0.27
DS30	10.30	8.39	4.19	2.75	0.27
DS60/DS100c/DS7c	11.87	10.45	5.00	3.81	0.33
DS100	16.06	11.77	6.75	4.25	0.31
DS200	15.76	11.54	8.13	6.38	0.31



30° Angle/Receptacle/Plug

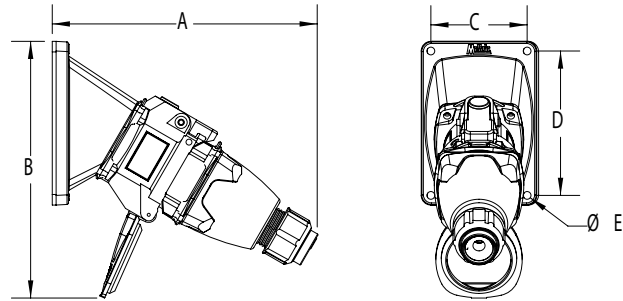

PRODUCT	A	B	C	D	øE
DS20	7.60	7.87	2.50	3.75	0.22
DS30	8.19	8.44	2.50	3.75	0.22
DS60/DS100c/DS7c	9.17	10.16	3.43	4.83	0.26
DS100	14.09	12.05	4.83	4.83	0.28
DS200	11.61	15.03	6.50	6.50	0.25

70° Wall Box/Receptacle

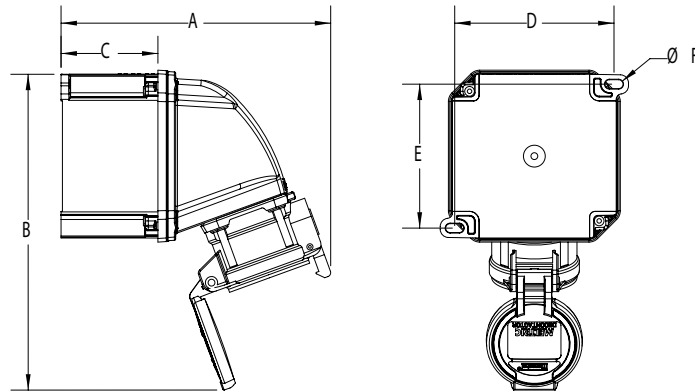

PRODUCT	A	B	C	D	E	øF
DS20	7.78	9.11	2.80	4.60	4.15	0.26
DS30*	8.91	11.55	2.80	6.17	5.73	0.26
DS60/DS100c/DS7c*	9.07	12.24	2.80	6.17	5.73	0.26

* Box has 4 mounting feet

Plug/Connector

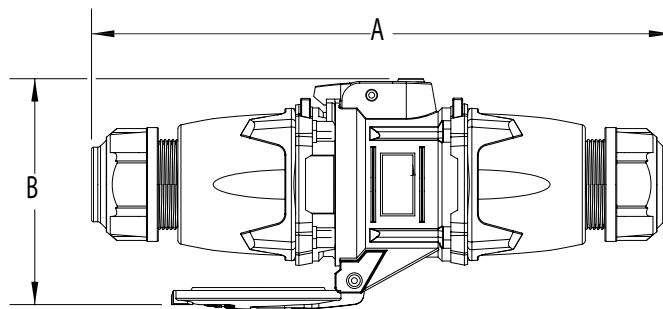

PRODUCT	A	B
DS20	10.20	4.61
DS30	10.91	5.71
DS60/DS100c/DS7c	12.17	6.57
DS100	19.53	8.03
DS200	23.15	8.00



DB Switch-Rated plug and receptacle

NOTE: The DB product line is being phased out in Q3 2019. Please consider alternative DSN and DS models.

Main Advantages

- ▶ Switch & Hp rated
- ▶ 100 kA short circuit rated*
- ▶ IP67 environmental ratings
- ▶ Up to 4 auxiliary contacts
- ▶ Durable metal construction

* See note under General Ratings on the next page.



Highlighted Advantage

! Simplify Compliance to NFPA 70E & CSA Z462 see pgs 18-19 for more information



- | | | | |
|------------------------|-------|---------------|-------|
| ▶ Features and Ratings | p. 57 | ▶ Spare parts | p. 66 |
| ▶ DB30 | p. 60 | ▶ Dimensions | p. 68 |
| ▶ DB60 | p. 62 | | |
| ▶ DB100 | p. 64 | | |

PRODUCT FEATURES

DECONTACTOR™ Technology

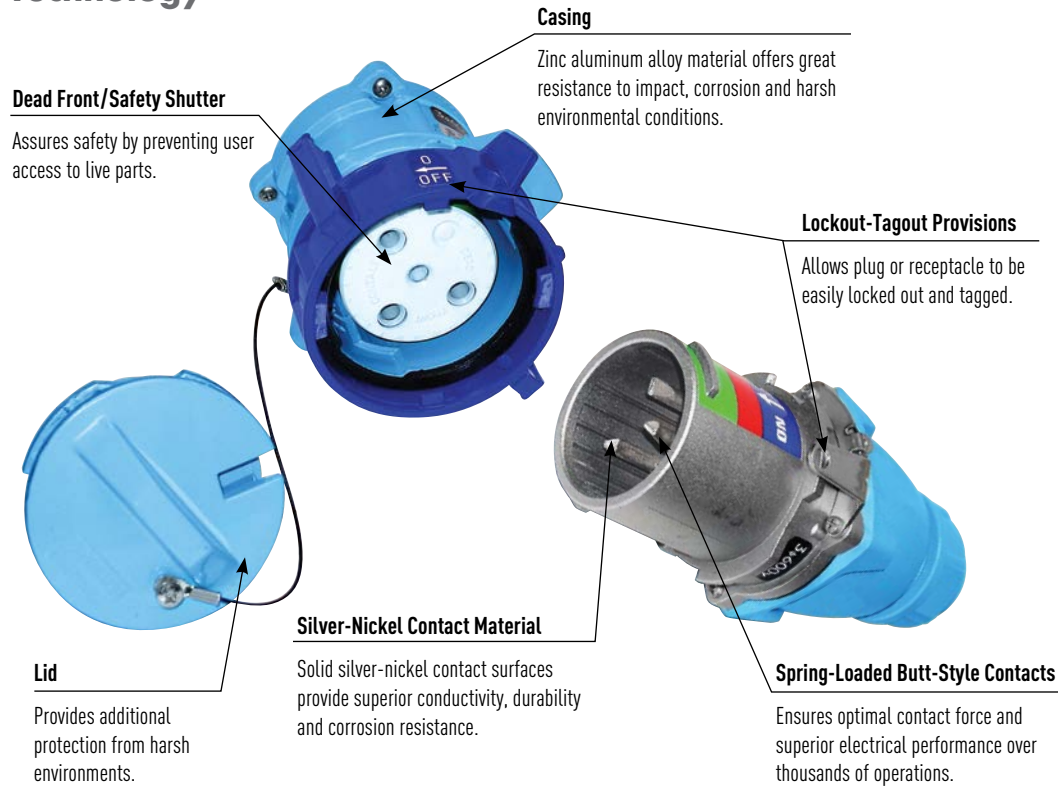

General Ratings

Amperage	30 to 100A
Voltage	600 VAC
Frequency	50-400 Hz
Horsepower	2 to 60 hp
Short-Circuit (Make & Withstand)	100kA*
Environmental	IP67
Temperature	min -40°F/max 140°F

* Testing was performed with RK1 current limiting fuses sized at 400% of the highest full load motor ampacity associated with the devices horsepower ratings, except for the DB100, which was tested with 250A fuses.

Highlighted Feature

Typical Device Labels

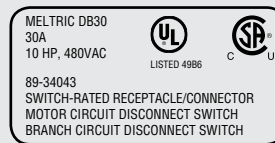

Meltric DB Series Switch-Rated devices are UL & CSA rated for "motor circuit" and "branch circuit" disconnect switching – up to 60 hp and up to 100A.

Listings

Category	UL	CSA	IEC
Plugs and Receptacles	UL 1682	C22.2 No. 182.1	60309-1
Branch Circuit Disconnect Switching (AC only)	UL Subject 2682 (Performance tests from UL 98)	UL Subject 2682	60947-3, AC22, AC23
Motor Circuit Disconnect Switching (AC only)	UL Subject 2682 (Performance tests from UL 98)	UL Subject 2682	60947-3, AC22, AC23

CE ratings available upon request.

Operating Instructions



When the plug and receptacle are latched together, the circuit is connected.



Turning the receptacle ring counterclockwise releases the plug and rapidly opens the circuit. The plug is ejected to its rest position.



From the rest position the 'dead' plug can be withdrawn by rotating it counterclockwise. The receptacle can be made watertight up to IP67 by replacing the lid and turning the locking ring fully clockwise.



To reconnect, insert plug and twist. Pushing the plug fully home safely makes the circuit. The plug is held in the 'on' position by a locking ring. IP67 protection is enabled by fully rotating the locking ring in the clockwise direction.

PRODUCT FEATURES

Spring-Loaded Operating Mechanism

DB Series Switch-Rated plugs and receptacles use an internal spring-loaded operating mechanism to open and close the contacts at high speed, independent of the manual motion of the user.

Load-Making

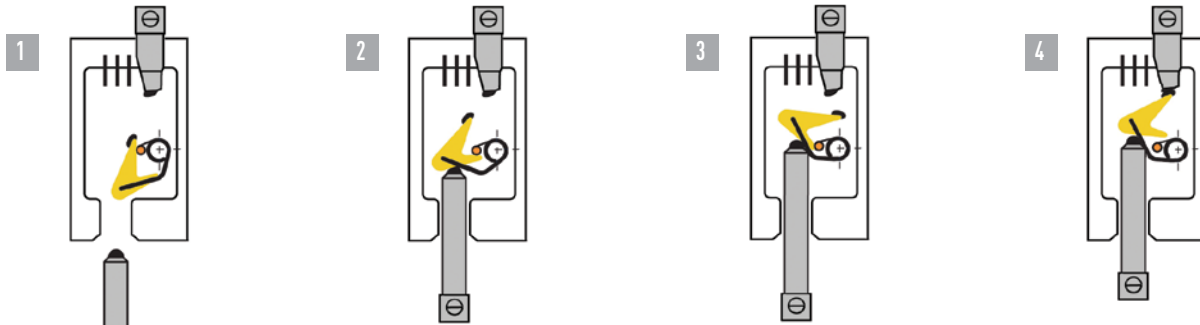

1. As the plug is first inserted into the receptacle, the contact travels toward the operating mechanism. Only the receptacle contact (shown at the top of the drawing) is live.
2. As the plug contact is inserted further, it engages a mobile intermediate contact on the operating mechanism, which it begins to move around a stop. This motion also begins to wind the operating spring.
3. As the plug is inserted further, to the almost completely engaged position, the operating spring becomes fully loaded and the mobile contact rotates into a position where any further insertion motion will release it from the stop.
4. As the last small insertion motion is made, the mobile contact clears the stop and releases the energy in the spring. This instantly drives the mobile contact into engagement with the receptacle contact and completes the electrical connection.

Load-Breaking

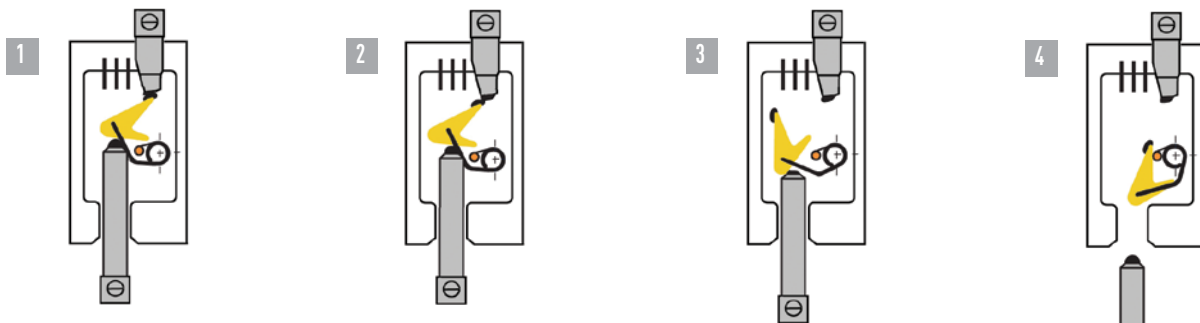

1. When the contacts are engaged, the operating spring is still almost fully charged. This maintains contact pressure and provides energy for the breaking operation.
2. In order to break the circuit, the plug retaining ring is turned to the 'off' position. This releases the plug, which in turn releases the mobile contact and the spring energy in the operating mechanism.
3. The spring energy instantly drives the mobile contact away from the live receptacle contact. It follows a different path than on making and is moved along an arc chute.
4. The mobile contact returns to its initial position, preparing the device to be used again.

Two Stage Contact System

The operation of the DB's contacts was specifically designed to ensure that load-breaking and load-carrying are performed in separate locations on the contacts.

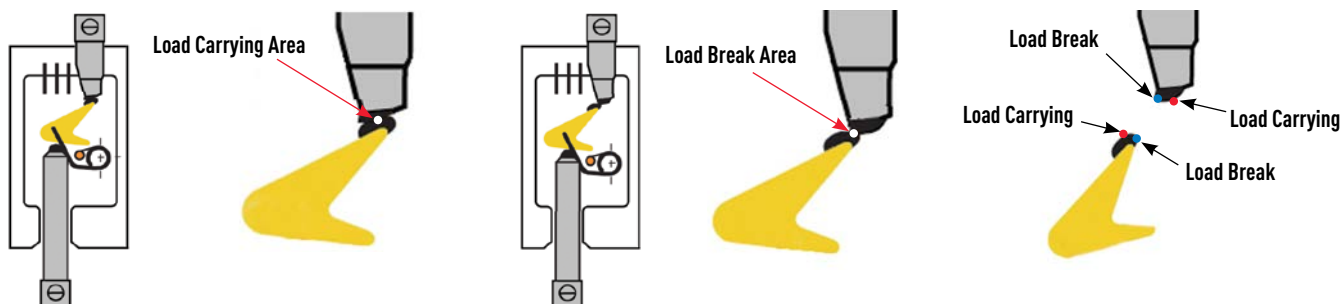

This is accomplished with the motion of the mobile contact relative to the receptacle contact. The opening of the contacts begins with a wiping action that moves the contact area toward the edges of the contacts, where load-breaking occurs. This allows numerous overload-breaking operations without deteriorating the main contact surfaces or the continuity of the connection.

Arc-Extinguishing System

For higher currents, or when significant overloads are involved, additional provision is desirable to handle the arcing that occurs during load-breaking. MELTRIC accomplishes this on its DB Series with a series of magnetic V-shaped blades, which create an arc chute.

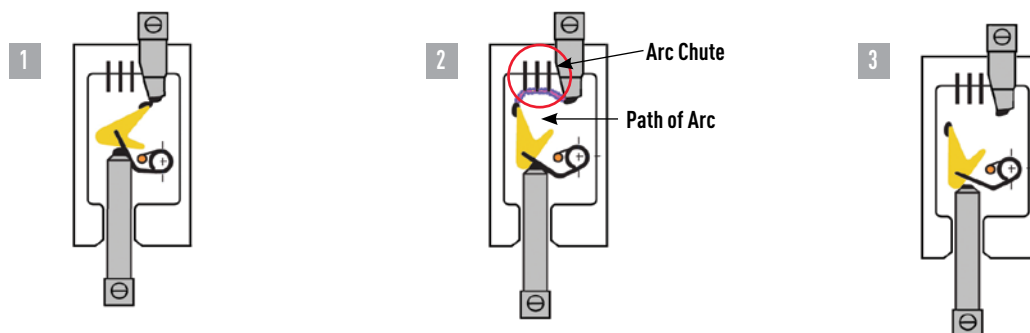

As the contacts open, the mobile intermediate contact moves along the arc chute. The arc is transferred to the magnetic "V" shaped blades, which splits and destabilizes it. This helps to cool and quickly extinguish the arc, minimizing any potential damage to the contacts. Together with the spring operator, two stage contact system and silver-nickel butt-style contacts, this feature allows the DB series to easily and safely break high horsepower inductive loads and significant overloads.

DB30 Switch-Rated Plugs & Receptacles – 30A

UL/CSA Ratings

- **Max Amperage & Voltage**
30A, 600 VAC
- **Switch-Rating (AC Only)**
Branch Circuit & Motor Circuit Disconnect Switching
- **Horsepower Ratings**

120V	1Ø	2 hp
240V	1Ø	3 hp
208V	3Ø	7 1/2 hp
240V	3Ø	7 1/2 hp
480V	3Ø	20 hp
600V	3Ø	25 hp
- **Short Circuit Rating**
100kA Close & Withstand
Testing was performed with RK1 current limiting fuses sized at 400% of the highest full load motor ampacity associated with the devices hp rating.
- **Environmental Ratings**
IP67
- **Temperature Range**
Min -40°F/Max 140°F
See pg 271 for temps below -15°F.
- **Wiring Capacity**
Min 14 AWG Max 8 AWG
Aux Contacts - Max 14 AWG
- **Certifications**
UL 2682, CSA 182.1

NOTE: The DB product line is being phased out in Q3 2019. Please consider alternative DSN and DS models.

Receptacle (female)



Inlet (male)



! Don't forget to add installation accessories to your order

North American UL/CSA Configurations

Voltage	Polarity	Part # Metal	Part # Metal
120V	1P+N+G	89-34165	89-38165
120 208V	3P+N+G	89-34167	89-38167
125V	1P+N+G	89-34075	89-38075
125 250V	2P+N+G	89-34076	89-38076
208V	2P+G	89-34162	89-38162
208V	3P+G	89-34163	89-38163
250V	2P+G	89-34072	89-38072
250V	3P+G	89-34073	89-38073
277V	1P+N+G	89-34045	89-38045
277 480V	3P+N+G	89-34047	89-38047
347 600V	3P+N+G	89-34147	89-38147
480V	2P+G	89-34042	89-38042
480V	3P+G	89-34043	89-38043
600V	2P+G	89-34142	89-38142
600V	3P+G	89-34143	89-38143

For international configurations and ratings (IEC, CE) visit meltric.com/international-catalog or contact customer service at 800.433.7642.

Main Options



Auxiliary/Pilot Contacts

Receptacle Options

Suffix

Inlet Options

Suffix

With 2 Auxiliary/Pilot Contacts

Recept # - 172*

With 2 Auxiliary/Pilot Contacts

Inlet # - 172*

Notes: * Auxiliary/Pilot Contacts are not available on DB devices with 1P+N+G, 2P+N+G or 3P+N+G polarity.





! See pages 248-257 for detailed information on these options



Order Example: 480V DB30 + 2 auxiliary contacts
DB30 Metal inlet 3P+G = 89-38043-172

INSTALLATION ACCESSORIES – SIZE 3





Unless indicated otherwise, accessories can be used with either poly or metal plugs and receptacles.

HANDLES

HANDLE w/NPT	Part # Poly	Part # Metal
 1/2"	513P0N05	593P0N05
 3/4"	513P0N07	593P0N07
 1"	513P0N10	593P0N10
 1 1/4"	513P0N12	593P0N12
For metal devices only 1 1/2"	-	593P0N15

HANDLE w/CORD GRIP	Cable Range	Poly	Metal
 .625 - .750"	.625 - .750"	713P0CP4	793P0CS4
 .770 - .875"	.770 - .875"	713P0DP2	793P0DS1
 .875 - 1.000"	.875 - 1.000"	713P0DP3	793P0DS3

NYLON HANDLE w/Cable Range	Cable Range	Part #
 .390 - 1.18"	.390 - 1.18"	513P0D30





POLY HANDLE w/CLAMP & BUSHING w/Cable Range	Cable Range	Part #
 .750 - .875"	.750 - .875"	713P0S14
 .875 - 1.000"	.875 - 1.000"	713P0S16
 1.000 - 1.125"	1.000 - 1.125"	713P0S18
 1.125 - 1.250"	1.125 - 1.250"	713P0S20
 1.250 - 1.375"	1.250 - 1.375"	713P0S22

For available cord grips, see pg 178.

Cable Range	NPT	Cable Range	NPT
.312 - .625	1/2"	.875 - 1.375"	1 1/4"
.438 - .812	3/4"	.890 - 1.812"	1 1/2"
.660 - 1.000	1"		



NPT sizes are determined by the cable diameter and third party cord grip.



ANGLES

METAL ANGLE	Angle	Part #
 0°	0°	593M0
 30°	30°	593M3
 FS/FD Box 30°	FS/FD Box 30°	793M3FS
 70°	70°	593M7

* Base measures approximately 4.2" x 2.7". Due to the variation in sizes of FS boxes, please verify that your FS box matches our dimensions, if not call Customer Service for other solutions.

BOXES

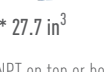
METAL BOX w/NPT	Angle	NPT	Part #
 0°	0°	1/2"	7T1F0N05
 0°	0°	3/4"	7T1F0N07
 0°	0°	1"	7T1F0N10
 0°	0°	1 1/4"	7T1F0N12

METAL BOX WITH METAL ANGLE w/NPT	Angle	NPT	Part #
 70°	70°	1/2"	793C7N05
 70°	70°	3/4"	793C7N07
 70°	70°	1"	793C7N10
 70°	70°	1 1/4"	793C7N12

* 27.7 in³ Interior volume with receptacle installed.

NPT on top or bottom (if rotated). For other NPT configurations, contact customer service.

MISCELLANEOUS ACCESSORIES

PROTECTIVE CAP	Part #	Notes
	89-3A126	For Male Devices Only.

CORD GRIP with or w/o MESH	Notes
	see pgs 178

EASY RETROFIT ADAPTER PLATES	Notes
	see pg 175 Mount to existing boxes.

DB60 Switch-Rated Plugs & Receptacles – 60A

UL/CSA Ratings

- **Max Amperage & Voltage**
60A, 600 VAC
- **Switch-Rating (AC Only)**
Branch Circuit & Motor Circuit Disconnect Switching
- **Horsepower Ratings**

120V	1Ø	3 hp
240V	1Ø	7.5 hp
208V	3Ø	15 hp
240V	3Ø	15 hp
480V	3Ø	30 hp
600V	3Ø	30 hp
- **Short Circuit Rating**
100kA Close & Withstand
Testing was performed with RK1 current limiting fuses sized at 400% of the highest full load motor ampacity associated with the devices hp rating.
- **Environmental Ratings**
IP67
- **Temperature Range**
Min -40°F/Max 140°F
See pg 271 for temps below -15°F.
- **Wiring Capacity**
Min 8 AWG Max 3 AWG
Aux Contacts - Max 14 AWG
- **Certifications**
UL 2682, CSA 182.1

NOTE: The DB product line is being phased out in Q3 2019. Please consider alternative DSN and DS models.

Receptacle (female)



Inlet (male)



! Don't forget to add installation accessories to your order

North American UL/CSA Configurations

Voltage	Polarity	Part # Metal	Part # Metal
120V	1P+N+G	89-64165	89-68165
120 208V	3P+N+G	89-64167	89-68167
125V	1P+N+G	89-64075	89-68075
125 250V	2P+N+G	89-64076	89-68076
208V	2P+G	89-64162	89-68162
208V	3P+G	89-64163	89-68163
250V	2P+G	89-64072	89-68072
250V	3P+G	89-64073	89-68073
277V	1P+N+G	89-64045	89-68045
277 480V	3P+N+G	89-64047	89-68047
347 600V	3P+N+G	89-64147	89-68147
480V	2P+G	89-64042	89-68042
480V	3P+G	89-64043	89-68043
600V	2P+G	89-64142	89-68142
600V	3P+G	89-64143	89-68143

For international configurations and ratings (IEC, CE) visit meltric.com/international-catalog or contact customer service at 800.433.7642.

Main Options



Auxiliary/Pilot Contacts

Receptacle Options

Suffix

Inlet Options

Suffix

With 2 Auxiliary/Pilot Contacts

Recept # - 172*

With 2 Auxiliary/Pilot Contacts

Inlet # - 172*

Notes: * Auxiliary/Pilot Contacts are not available on DB devices with 1P+N+G, 2P+N+G or 3P+N+G polarity.





! See pages 248-257 for detailed information on these options

Order Example: 480V DB60 + 2 auxiliary contacts
DB60 Metal inlet 3P+G = 89-68043-172



INSTALLATION ACCESSORIES – SIZE 4

Unless indicated otherwise, accessories can be used with either poly or metal plugs and receptacles.

HANDLES

HANDLE w/NPT	Part # Poly	Part # Metal
 1/2"	514P0N05	594P0N05
 3/4"	514P0N07	594P0N07
 1"	514P0N10	594P0N10
 1 1/4"	514P0N12	594P0N12

For metal devices only 1 1/2" 514P0N15 594P0N15

HANDLE w/CORD GRIP	Cable Range	Poly	Metal
	.750-.875"	714P0DP2	794P0DS1
	.875-1.000"	714P0DP3	794P0DS3
	1.000-1.125"	714P0EP2	794P0ES2

For metal devices only

NYLON HANDLE w/Cable Range		
	.51 - 1.38"	514P0D35

POLY HANDLE w/CLAMP & BUSHING w/Cable Range		
	1.250 - 1.375"	714P0S22
	1.438 - 1.562"	714P0S25
	1.562 - 1.688"	714P0S27
	1.688 - 1.812"	714P0S29





For available cord grips, see pg 178.

i

Cable Range	NPT	Cable Range	NPT
.312 - .625	1/2"	.875 - 1.375"	1 1/4"
.438 - .812	3/4"	.890 - 1.812"	1 1/2"
.660 - 1.000	1"		

NPT sizes are determined by the cable diameter and third party cord grip.

ANGLES

METAL ANGLE		
	0°	594M0
	30°	594M3
	30°	794M3L
	Oversized 30°	794M3
		Mounts on oversize box only. Order with 7T4F0Nxx box. See page 64.
	70°	594M7

BOXES



METAL BOX w/NPT			
	0°	1"	7T4F0N10
	0°	1 1/4"	7T4F0N12
	0°	1 1/2"	7T4F0N15
	0°	2"	7T4F0N20

METAL BOX WITH METAL ANGLE w/NPT			
	70°	1"	794C7N10
	70°	1 1/4"	794C7N12
	70°	1 1/2"	794C7N15
* 91.0 in ³	70°	2"	794C7N20

* Interior volume with receptacle installed.

NPT on top or bottom (if rotated). For other NPT configurations, contact customer service.

MISCELLANEOUS ACCESSORIES

PROTECTIVE CAP		
	89-6A126	For Male Devices Only.
CORD GRIP with or w/o MESH		
	see pgs 178	
EASY RETROFIT ADAPTER PLATES		
	see pg 175	Mount to existing boxes.

DB100 Switch-Rated Plugs & Receptacles – 100A

UL/CSA Ratings

- **Max Amperage & Voltage**
100A, 600 VAC
- **Switch-Rating (AC Only)**
Branch Circuit & Motor Circuit Disconnect Switching
- **Horsepower Ratings**

120V	1Ø	7 1/2 hp
240V	1Ø	15 hp
208V	3Ø	30 hp
240V	3Ø	30 hp
480V	3Ø	60 hp
600V	3Ø	60 hp
- **Short Circuit Rating**
100kA Close & Withstand
Testing was performed with 250A RK1 fuses, so the 100kA rating applies up to 60 hp @ 600, 40 hp @ 480V and 20 hp @ 240V and 208V.
- **Environmental Ratings**
IP67
- **Temperature Range**
Min -40°F/Max 140°F
See pg 271 for temps below -15°F.
- **Wiring Capacity**
Min 1/0- AWG Max 2/0 AWG
Aux Contacts - Max 14 AWG
+ Smaller conductors can be retained in the terminal, but may result in a temperature rise greater than the 30° max allowed in UL & CSA standards.
- **Certifications**
UL 2682, CSA 182.1

NOTE: The DB product line is being phased out in Q3 2019. Please consider alternative DSN and DS models.

Receptacle (female)



Inlet (male)



! Don't forget to add installation accessories to your order

North American UL/CSA Configurations

Voltage	Polarity	Part # Metal	Part # Metal
120V	1P+N+G	89-94165	89-98165
120 208V	3P+N+G	89-94167	89-98167
125V	1P+N+G	89-94075	89-98075
125 250V	2P+N+G	89-94076	89-98076
208V	2P+G	89-94162	89-98162
208V	3P+G	89-94163	89-98163
250V	2P+G	89-94072	89-98072
250V	3P+G	89-94073	89-98073
277V	1P+N+G	89-94045	89-98045
277 480V	3P+N+G	89-94047	89-98047
347 600V	3P+N+G	89-94147	89-98147
480V	2P+G	89-94042	89-98042
480V	3P+G	89-94043	89-98043
600V	2P+G	89-94142	89-98142
600V	3P+G	89-94143	89-98143

For international configurations and ratings (IEC,CE) visit meltric.com/international-catalog or contact customer service at 800.433.7642.

Main Options



Auxiliary/Pilot Contacts

Receptacle Options

Suffix

Inlet Options

Suffix

With 4 Auxiliary/Pilot Contacts

Recept # - 174**

With 4 Auxiliary/Pilot Contacts

Inlet # - 174**

Notes: * DB100 devices with auxiliary/pilot contacts are not UL/CSA listed.

** Auxiliary/Pilot Contacts are not available on DB devices with 1P+N+G, 2P+N+G or 3P+N+G polarity.

! See pages 248-257 for detailed information on these options





Order Example: 480V DB100 + 4 auxiliary contacts





DB100 Metal inlet 3P+G = 89-98043-174



INSTALLATION ACCESSORIES – SIZE 5

Unless indicated otherwise, accessories can be used with either poly or metal plugs and receptacles.

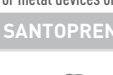
HANDLES

HANDLE w/NPT	Part # Poly	Part # Metal
 3/4"	515P0N07	595P0N07
 1"	515P0N10	595P0N10
 1 1/4"	515P0N12	595P0N12
 1 1/2"	515P0N15	595P0N15
For metal devices only 2"	515P0N20	595P0N20

HANDLE w/CORD GRIP	Cable Range	Poly	Metal
	1.270 - 1.470"	715P0EP3	-
	1.250 - 1.375"	-	795P0ES4
	1.438 - 1.562"	-	795P0FS2
	1.562 - 1.688"	-	795P0FS3
For metal devices only	1.520 - 1.860"	715P0GP2	-

SANTOPRENE HANDLE w/Cable Range		
	.70 - 1.000"	555P0D25
	1.00 - 1.375"	555P0D35
IP 66/67	1.375 - 1.750"	555P0D45

POLY HANDLE w/CLAMP & BUSHING w/Cable Range	
	1.250 - 1.375" 715P0S22
	1.438 - 1.562" 715P0S25
	1.562 - 1.688" 715P0S27
	1.688 - 1.812" 715P0S29

For available cord grips, see pg 178.

BOXES

METAL BOX w/NPT			
	0°	1 1/4"	7T5F0N12
	0°	1 1/2"	7T5F0N15
	0°	2"	7T5F0N20

METAL BOX WITH METAL ANGLE w/NPT			
	70°	1 1/4"	795C7N12
	70°	1 1/2"	795C7N15
	70°	2"	795C7N20

* 175.0 in³

* Interior volume with receptacle installed.





NPT on top or bottom (if rotated). For other NPT configurations, contact customer service.

i

Cable Range	NPT	Cable Range	NPT
.438 - .812	3/4"	.890 - 1.812"	1 1/2"
.660 - 1.000	1"	1.190 - 2.438"	2"
.875 - 1.375"	1 1/4"		

NPT sizes are determined by the cable diameter and third party cord grip.

ANGLES

METAL ANGLE		
	0°	595M0
	30°	595M3
	30°	795M3
	70°	595M7

Mounts on oversize box only. Order with 7T5F0Nxx box. See page 64.

MISCELLANEOUS ACCESSORIES

PROTECTIVE CAP		
	89-9A126	For Male Devices Only.

CORD GRIP with or w/o MESH	
	see pgs 175

EASY RETROFIT ADAPTER PLATES		
	see pg 175	Mount to existing boxes.

DB SPARE PARTS Male Configuration

NOTE: The DB product line is being phased out in Q3 2019. Please consider alternative DSN and DS models.

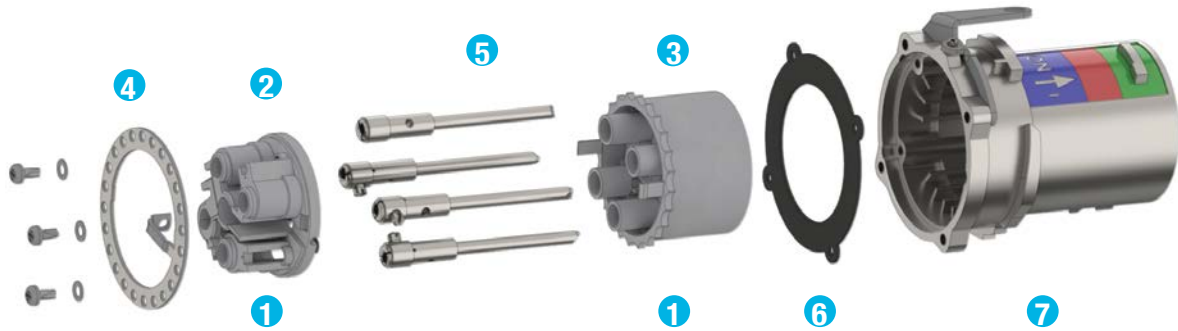

	DB30 METAL	DB60 METAL	DB100 METAL
1 Plug Interior with Pilot Contact Assembly	89-3A010-172*	89-6A010-172*	89-9A010-174*
1 Plug Interior without Pilot Contact Assembly	89-3A010	89-6A010	89-9A010
2 Interior Bottom***	89-3A010-B	89-6A010-B	89-9A010-B
3 Interior Top for Pilot Contact Assembly	89-3A010-T-172*	89-6A010-T-172*	89-9A010-T-174*
3 Interior Top w/o Pilot Contact Assembly Holes	89-3A010-T*	89-6A010-T*	89-9A010-T*
4 Metal Locking Ring/Ground Ring	89-3A523	89-6A523	89-9A523
5 Ground Contact	89-3A019	89-6A019	89-9A019
5 Phase or Neutral Contact	89-3A011	89-6A011	89-9A011
5 Pilot (2 Contacts) Assembly (not shown)	89-3A219-172	89-6A219-172	-
5 Pilot (4 Contacts) Assembly (not shown)	-	-	89-9A219-174
6 Device Gasket	89-3A026	89-6A026	89-9A026
7 Plug Metal Casing	89-3A014**	89-6A014**	89-9A014**

* Voltage and phasing positions must be specified (5th, 6th & 7th digit of Part #) to duplicate your shutter and alignment notches.

** For appropriate labeling on a device, please specify voltage, phasing, and product type.

DB SPARE PARTS Female Configuration

NOTE: The DB product line is being phased out in Q3 2019. Please consider alternative DSN and DS models.

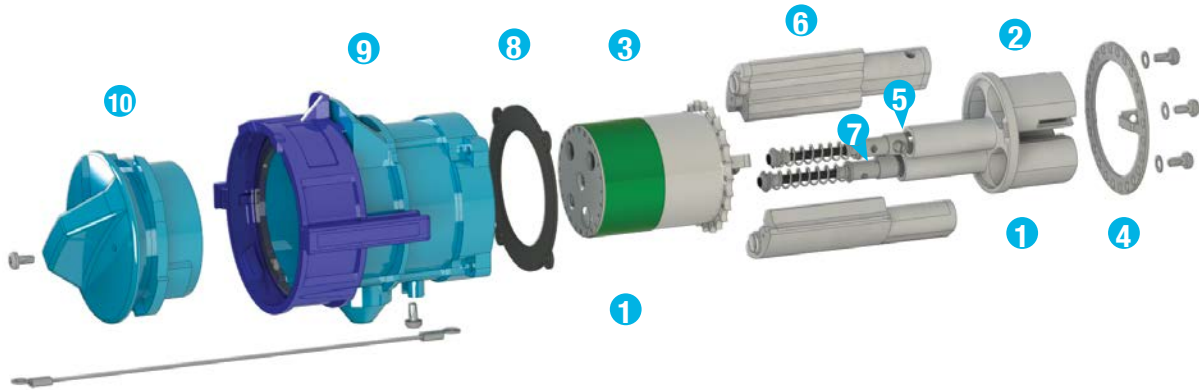

	DB30 METAL	DB60 METAL	DB100 METAL
① Receptacle Interior w/Pilot Contact Assembly	89-3A020-172*	89-6A020-172*	89-9A020-174*
① Receptacle Interior w/o Pilot Contact Assembly	89-3A020*	89-6A020*	89-9A020*
② Interior Bottom***	89-3A020-B	89-6A020-B	89-9A020-B
③ Interior Top for Pilot Contact Assembly	89-3A020-T-172*	89-6A020-T-172*	89-9A020-T-174*
③ Interior Top for Pilot Contact Assembly Holes	89-3A020-T*	89-6A020-T*	89-9A020-T*
④ Metal Locking Ring/Ground Ring	89-3A523	89-6A523	89-9A523
⑤ Ground Contact	89-3A029	89-6A029	89-9A029
⑥ Phase Contact	89-3A021	89-6A021	89-9A021
⑦ Neutral Contact	89-3A021N	89-6A021N	89-9A021N
⑦ Pilot (2 Contacts) Assembly (not shown)	89-3A229-172	89-6A229-1726	-
⑦ Pilot (4 Contacts) Assembly (not shown)	-	-	89-9A229-174
⑧ Device Gasket	89-3A026	89-6A026	89-9A026
⑨ Receptacle Metal Casing	89-3A024**	89-6A024**	89-9A024**
⑩ Protective Cap with Nylon Cord	89-3A925**	89-6A925**	89-9A925**

* Voltage and phasing positions must be specified (5th, 6th & 7th digit of Part #) to duplicate your shutter and alignment notches.

** For appropriate labeling on a device, please specify voltage, phasing, and product type.

DB DIMENSIONS Inlet – Provided in inches

Dimensions are for reference only and may change depending on accessories used. For precise dimensions contact MELTRIC Engineering.

NOTE: The DB product line is being phased out in Q3 2019. Please consider alternative DSN and DS models.

Inlet

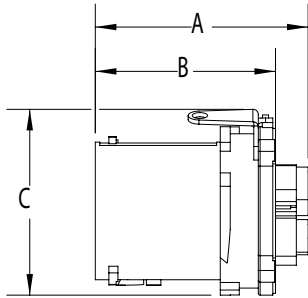

Plug

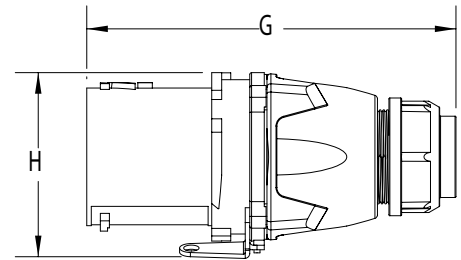
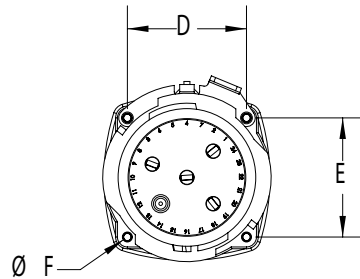

PRODUCT	A	B	C	D	E	øF	G	H
DB30	4.42	3.75	3.11	2.19	2.19	0.18	7.89	3.15
DB60	4.63	3.92	4.04	2.59	2.59	0.22	8.03	4
DB100	6.28	4.63	4.33	3.2	3.2	0.22	9.78	4.46

Receptacle

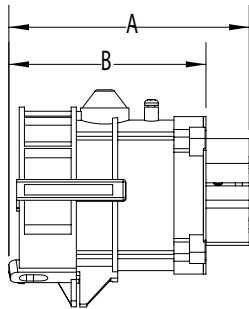

Connector

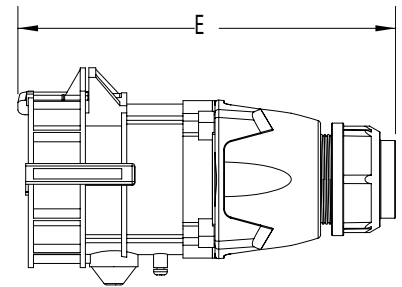
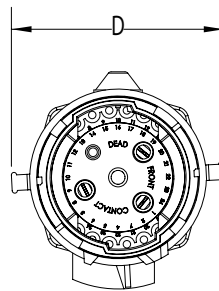

PRODUCT	A	B	C	D	E
DB30	6.17	5.16	3.54	4.36	8.02
DB60	6.52	5.46	4.02	4.84	8.59
DB100	8.52	6.77	4.94	5.75	10.67



NOTE: The DB product line is being phased out in Q3 2019. Please consider alternative DSN and DS models.

**Junction Box /70° Angle/
Receptacle/with Plug**

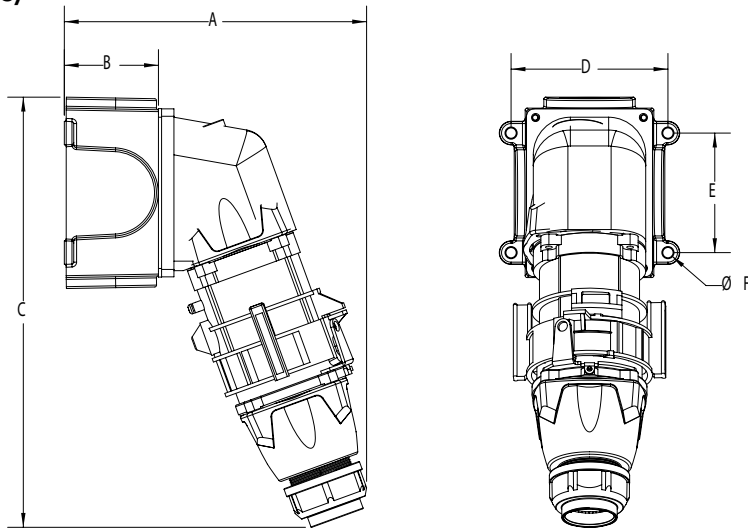

PRODUCT	A	B	C	D	E	F
DB30	8.54	2.27	11.65	4.19	2.75	0.27
DB60	9.63	3	13.71	5	3.81	0.33
DB100	12.24	3.77	17.6	6.75	4.25	0.31

Connector/Plug

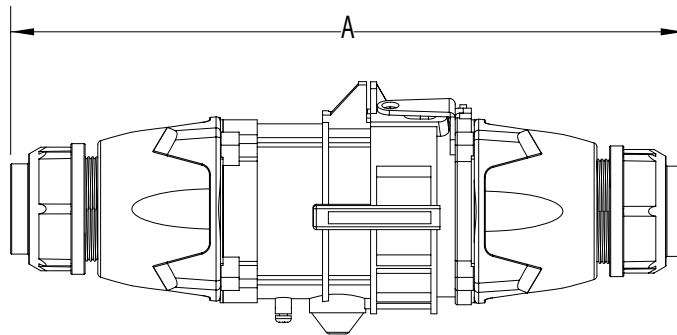

PRODUCT	A
DB30	13.01
DB60	13.19
DB100	16.65



MULTIPIN

Plugs & Receptacles



MELTRIC offers a broad range of multipin devices for use in a wide variety of control and power applications. Each device features MELTRIC's spring-loaded, silver-nickel butt-style contact technology that maximizes durability and performance. Multipin devices are available with as many as 37 or as few as 4 contacts. Products range from 2A up to 50A per contact and some include load making and breaking capabilities and/or horsepower ratings.



PN7C P. 74

COMPACT 5 TO 7 PIN CONNECTORS

- Up to 20A per contact
- IP66/IP67
- Poly or metal casings



DN9C P. 82

HP RATED CONNECTORS-9 PINS

- Up to 5 hp/480V
- Multiple power or control circuits
- Metal casings



PN12C P. 76

COMPACT 12 PIN CONNECTORS

- Up to 7.5A per contact
- IP66/IP67
- Poly or metal casings



DN20C P. 84

HP RATED CONNECTORS-20 PINS

- Up to 3 hp/480V
- Multiple power or control circuits
- Metal casings



DSN24C P. 78

POLY CONNECTORS UP TO 24 PINS

- Up to 7.5A per contact
- IP66/IP67
- Crimp or solder terminals



DS7C3 P. 86

HIGHER AMP 4 TO 7 PIN CONNECTOR

- Up to 30A per contacts
- Suitable for current interrupting
- Up to 3 auxiliary contacts



DSN37C P.80

POLY CONNECTORS UP TO 37 PINS

- Up to 7.5A per contact
- IP66/IP67
- Crimp or solder terminals



DR7C3 P. 88

HIGHER AMP 4 TO 7 PIN CONNECTOR

- Up to 50A per contacts
- Non-current interrupting
- Up to 3 auxiliary contacts







CRIMPING CONTACTS

PN12C/DSN24C/DSN37C

ECONOMIC AND TECHNICAL ADVANTAGES

Crimping ensures an economical and sustainable solution through installation time saving and quality of connection.

- No need for soldering performance qualifications.
- High resistance to vibrations.
- Handling more than 5000 operations: a high durability and quality of connection guaranteed.

ACCESSORIES AND OPTIONS	DESIGNATION	REFERENCE
	Bag of 13 females contacts	01-AA213
	Bag of 13 males contacts - PN12c	01-AA113
	Bag of 13 males contacts - DSN24c/37c	61-CA113
	Multi-Contact removal tool	61-CA593
	European crimping tool	61-CA500
	Crimper Tool (Greenlee or equal)	4CN30

FAST WIRING

- Cable conductors: 1 mm² to 2.5 mm²
- Before wiring, equip each conductor with a heat-shrink sleeve or an insulating sleeve.
- After wiring, cover the visible portion of the contact with the sleeve.
- Crimp the contact with a KNIPEX crimping tool P/N° 61CA500 or a GREENLEE crimping tool P/N° 45505.
- Use the 4 mm² footprint whatever the conductor cross-section.
- Perform a double crimping in compliance with CEI 60352-2 standard.
- Conductors can equally be soldered.

SIMPLE ASSEMBLY AND DISASSEMBLY

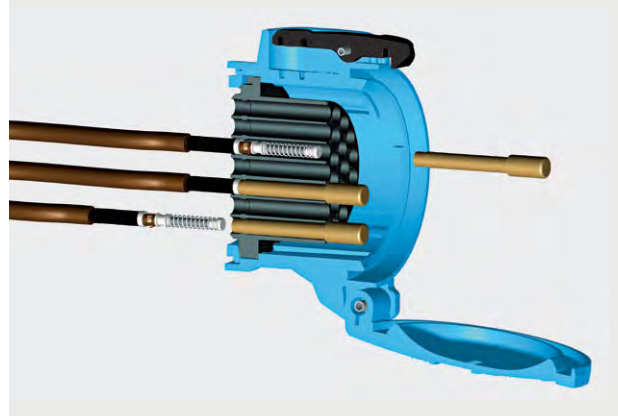
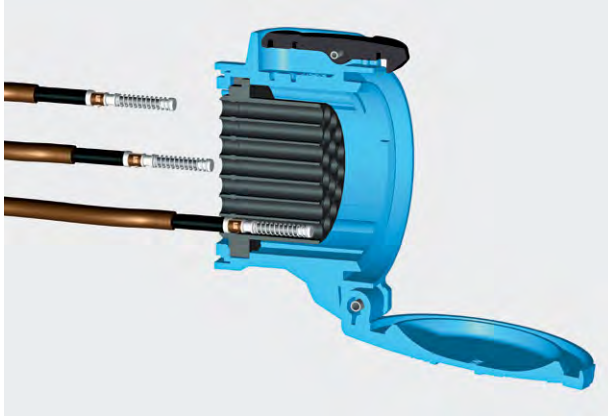

Assembly

To insert contacts when they have been wired is simple. Push wired contact into rear of insulator until it stops to complete the installation.

Disassembly

To remove, use the tool provided. Push tool from front onto contact until tool stops. Contact is then released at rear of insulator.

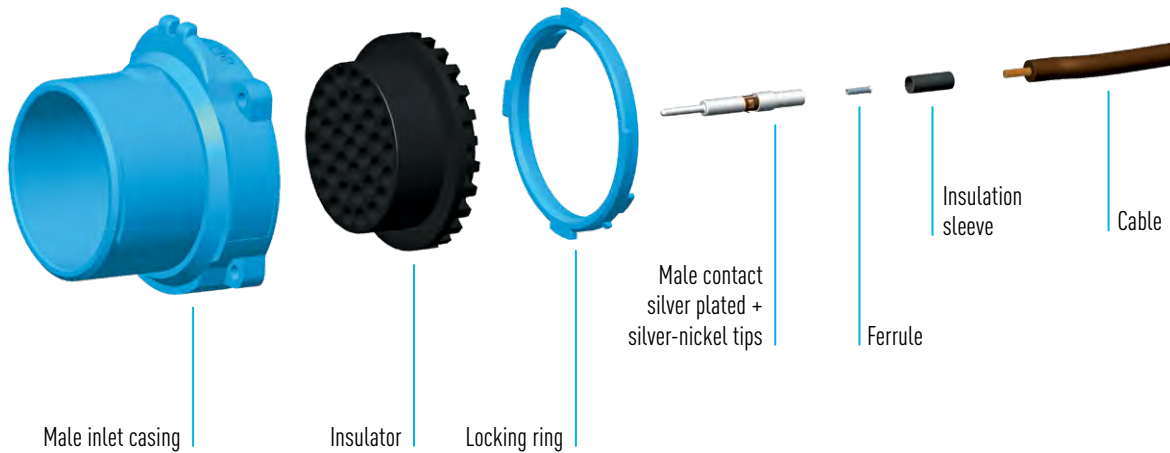
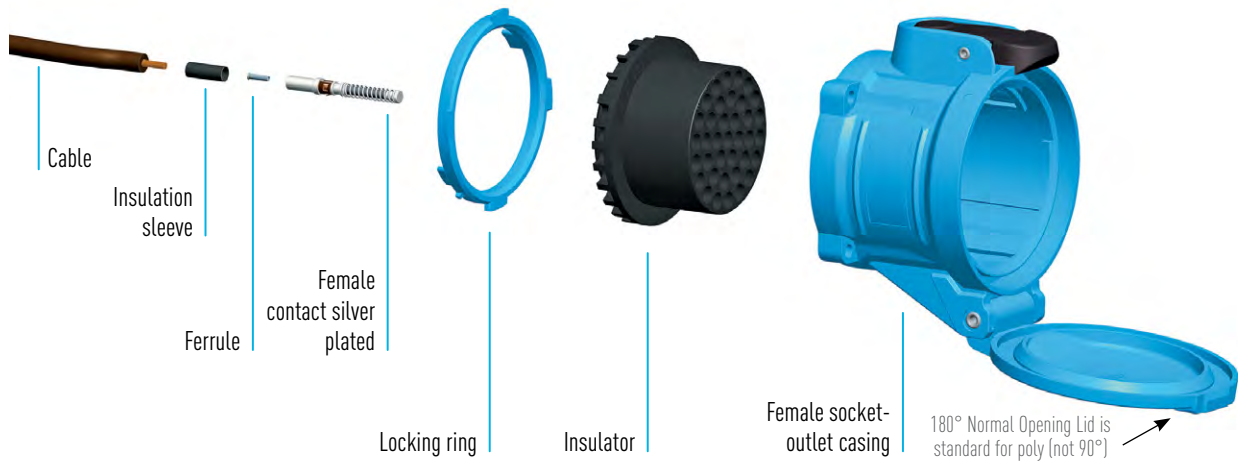

PN7c Multipin Plugs & Receptacles – 20A

Ratings

- **Voltage**
600 VAC Max/130 VDC*
- **Amperage Rating**
15A Current Interrupting
20A Non-Current Interrupting
! Capable of handling 4-20mA low current applications
- **Environmental Ratings**
IP66/IP67* (Poly/Metal)
- **Temperature Range**
Min -40°F/Max 140°F
See pg 271 for temps below -15°F.
- **Wiring Capacity**
Min 18 AWG Max 10 AWG
- **Certifications**
UL*, CSA*, CE*+
* Contact Customer Service
+ Poly/metal versions only

Receptacle (female)



Inlet (male)



! Don't forget to add installation accessories to your order

North American Configurations

Voltage	Polarity	Part #			Part #		
		Poly	Metal	Stainless Steel	Poly	Metal	Stainless Steel
600V	4P+G	01-P4041	09-P4041	09-04041-SS	01-P8041	09-P8041	09-08041-SS
600V	5P+G	01-P4051	09-P4051	09-04051-SS	01-P8051	09-P8051	09-08051-SS
600V	6P+G	01-P4061	09-P4061	09-04061-SS	01-P8061	09-P8061	09-08061-SS

For international configurations and ratings (IEC,CE) visit meltric.com/international-catalog or contact customer service at 800.433.7642.

Main Options



Reverse Interiors



Flush Mount
(replaces female casing)



Locking Pawl

Receptacle Options

Suffix

Inlet Options

Suffix

Reverse Interiors

Recept # - 001

Reverse Interiors

Inlet # - 001

With Flush Mount (poly only)

Recept # - 142*

Locking Pawl

Recept # - 824-300

* IP55 rating with Flush Mount casing



! See pages 248-257 for detailed information on these options





Order Example: 600V PN7c + Reverse Interiors
PN7c Receptacle 5P+G = 01-P4051-**001**



INSTALLATION ACCESSORIES – SIZE 1



Unless indicated otherwise, accessories can be used with either poly or metal plugs and receptacles.

HANDLES

HANDLE w/NPT	Part # Poly	Part # Metal
 1/2"	511P0N05	591P0N05
 3/4"	511P0N07	591P0N07
 1"	511P0N10	591P0N10

HANDLE w/CORD GRIP Cable Range	Poly	Metal
 .438 - .500"	711P0BP3	791P0BS3
 .500 - .562"	711P0BP4	791P0BS4
 .562 - .625"	711P0BP5	791P0BS5
 .625 - .750"	711P0CP4	791P0CS4

90° NYLON HANDLE Threaded Opening w/NPT	Part # Poly	Part # Metal
 1/2"	751P9N05	
 3/4"	751P9N07	
 1"	751P9N10	

STAINLESS STEEL HANDLE w/NPT	Part # Poly	Part # Metal
 1/2"	7X1P0N05	For 1/2" NPT size, a hole size reducer is utilized
 3/4"	7X1P0N07	

NYLON HANDLE w/Cable Range	Part # Poly	Part # Metal
 .35 - .69"	511P0D18	

ANGLED NYLON HANDLE w/Cable Range	Part # Poly	Part # Metal
 .35 - .69"	511P6D18	

For available cord grips, see pg 178

i

Cable Range	NPT	Notes
.312 - .625	1/2"	NPT sizes are determined by the cable diameter and third party cord grip.
.438 - .812	3/4"	
.660 - 1.000	1"	

ANGLES

NYLON ANGLE	Part # Poly	Part # Metal
 30° for MB Box	511M3	

METAL ANGLE	Part # Poly	Part # Metal
 0°	591M0	



NYLON ANGLE	Part # Poly	Part # Metal
 FS/FD Box 30°	791M3FS	

* Base measures approximately 4.2" x 2.7". Due to the variation in sizes of FS boxes, please verify that your FS box matches our dimensions, if not call Customer Service for other solutions.

NYLON ANGLE	Part # Poly	Part # Metal
 45°	591M4	

STAINLESS STEEL ANGLE	Part # Poly	Part # Metal
 30°	7X1M4	



BOXES





POLY CONDUIT ENTRY w/NPT	Part # Poly	Part # Metal
 30°	511B3N05	
 * 7.0 in ³ 30°	511B3N07	* Interior volume with receptacle installed.





POLY WALL BOX w/NPT	Part # Poly	Part # Metal
 0°	511B0N05	
 * .5 in ³ 0°	511B0N07	* Interior volume with receptacle installed.



METAL WALL BOX w/NPT	Part # Poly	Part # Metal
 0°	591B0N05	
 * 3.8 in ³ 0°	591B0N07	* Interior volume with receptacle installed.

POLY WALL BOX w/NPT	Part # Poly	Part # Metal
 70°	511C7000	
 * 82.0 in ³		70° poly boxes are not drilled. Contact customer service if factory drilled is required. * Interior volume with receptacle installed.

METAL BOX w/NPT	Part # Poly	Part # Metal
 0°	7T1F0N05	
 0°	7T1F0N07	
 0°	7T1F0N10	
 0°	7T1F0N12	

METAL BOX WITH NYLON ANGLE w/NPT	Part # Poly	Part # Metal
 30°	711C3N05	
 30°	711C3N07	
 30°	711C3N10	
 * 30.1 in ³ 30°	711C3N12	* Interior volume with receptacle installed.

METAL BOX WITH METAL ANGLE w/NPT	Part # Poly	Part # Metal
 45°	791C4N05	
 45°	791C4N07	
 45°	791C4N10	
 * 27.0 in ³ 45°	791C4N12	

STAINLESS STEEL BOX WITH STAINLESS STEEL ANGLE w/NPT	Part # Poly	Part # Metal
 30°	7X1C3N07	
 30°	7X1C3N10	* Includes angle adapter as shown.

NPT on top or bottom (if rotated). For other NPT configurations, contact customer service.

MISCELLANEOUS ACCESSORIES

PROTECTIVE CAP	Part # Poly	Part # Metal
 01-2A126	01-2A126	Will not fit devices with reverse interiors. For Male Devices Only.

FLUSH MOUNT	Part # Poly	Part # Metal
 01-2A142	01-2A142	

CORD GRIP with MESH	Part # Poly	Part # Metal
 see page 178		see page 178

PN12c Multipin Plugs & Receptacles – 7.5A

Ratings

- **Voltage**
600 VAC Max/130 VDC
- **Amperage Rating**
5A Current Interrupting
7.5A Non-Current Interrupting
! PN12c is capable of handling
4-20mA low current applications
- **Environmental Ratings**
*IP66/IP67 (Poly/Metal)
- **Temperature Range**
Min -40°F / Max 140°F
See pg 271 for temps below -15°F.
- **Wiring Capacity**
Min 18 AWG Max 14 AWG
- **Certifications**
UL Coming Soon!

Receptacle (female)



Inlet (male)



! Don't forget to add installation accessories to your order

North American Configurations

Voltage	Polarity	Part #			Part #		
		Poly	Metal	Stainless Steel	Poly	Metal	Stainless Steel
600V	11P+G	03-A4001	07-A4001	07-A4001-SS	03-A8001	07-A8001	07-A8001-SS

For international configurations and ratings (IEC, CE) visit meltric.com/international-catalog or contact customer service at 800.433.7642.

Main Options



Reverse Interiors



Flush Mount
(replaces female casing)



Locking Pawl

Receptacle Options

Suffix

Inlet Options

Suffix

Reverse Interiors	Recept # - 001	Reverse Interiors	Inlet # - 001
With Flush Mount (poly only)	Recept # - 142*		
Locking Pawl	Recept # - 824-300		

* IP55 rating with Flush Mount casing



! See pages 248-257 for detailed information on these options





Order Example: 600V PN12c + Reverse Interiors
PN12c Receptacle 11P+G = 03-A4001-001



INSTALLATION ACCESSORIES – SIZE 1



Unless indicated otherwise, accessories can be used with either poly or metal plugs and receptacles.

HANDLES

HANDLE w/NPT	Part # Poly	Part # Metal
 1/2"	511P0N05	591P0N05
 3/4"	511P0N07	591P0N07
 1"	511P0N10	591P0N10

HANDLE w/CORD GRIP Cable Range	Poly	Metal
 .438 - .500"	711P0BP3	791P0BS3
 .500 - .562"	711P0BP4	791P0BS4
 .562 - .625"	711P0BP5	791P0BS5
 .625 - .750"	711P0CP4	791P0CS4

90° NYLON HANDLE Threaded Opening w/NPT	Part # Poly	Part # Metal
 1/2"	751P9N05	
 3/4"	751P9N07	
 1"	751P9N10	

STAINLESS STEEL HANDLE w/NPT	Part # Poly	Part # Metal
 1/2"	7X1P0N05	For 1/2" NPT size, a hole size reducer is utilized
 3/4"	7X1P0N07	
 1"	7X1P0N10	

NYLON HANDLE w/Cable Range	Part # Poly	Part # Metal
 .35 - .70"	511P0D18	

ANGLED NYLON HANDLE w/Cable Range	Part # Poly	Part # Metal
 .35 - .70"	511P6D18	

For available cord grips, see pg 178
 For a guideline of NPT based cable ranges, see PN7c on pg 75.

ANGLES

NYLON ANGLE	Part # Poly	Part # Metal
 30° for MB Box	511M3	

METAL ANGLE	Part # Poly	Part # Metal
 0°	591M0	



Part # Poly	Part # Metal
 FS/FD Box 30°	791M3FS

* Base measures approximately 4.2" x 2.7". Due to the variation in sizes of FS boxes, please verify that your FS box matches our dimensions, if not call Customer Service for other solutions.



Part # Poly	Part # Metal
 45°	591M4

Part # Poly	Part # Metal
 30°	7X1M4



BOXES

POLY CONDUIT ENTRY w/NPT	Part #
 30° 1/2"	511B3N05
 30° 3/4"	511B3N07

* 6.9 in³

POLY WALL BOX w/NPT	Part #
 0° 1/2"	511B0N05
 0° 3/4"	511B0N07

* 3.4 in³





METAL WALL BOX w/NPT	Part #
 0° 1/2"	591B0N05
 0° 3/4"	591B0N07





* Interior volume with receptacle installed.

POLY WALL BOX w/NPT	Part #
 70° 1/2" - 1 1/4"	511C7000

* 82.0 in³

70° poly boxes are not drilled. Contact customer service if factory drilled is required.
 * Interior volume with receptacle installed.

METAL BOX w/NPT	Part #
 0° 1/2"	7T1F0N05
 0° 3/4"	7T1F0N07
 0° 1"	7T1F0N10
 0° 1 1/4"	7T1F0N12

METAL BOX WITH NYLON ANGLE w/NPT	Part #
 30° 1/2"	711C3N05
 30° 3/4"	711C3N07
 30° 1"	711C3N10
 30° 1 1/4"	711C3N12

* 30.0 in³

* Interior volume with receptacle installed.

METAL BOX WITH METAL ANGLE w/NPT	Part #
 45° 1/2"	791C4N05
 45° 3/4"	791C4N07
 45° 1"	791C4N10
 45° 1 1/4"	791C4N12

* 26.9 in³

* Interior volume with receptacle installed.

STAINLESS STEEL BOX WITH STAINLESS STEEL ANGLE w/NPT	Part #
 30° 3/4"	7X1C3N07
 30° 1"	7X1C3N10

* Includes angle adapter as shown.

MISCELLANEOUS ACCESSORIES

PROTECTIVE CAP	Part #
 01-2A126	Will not fit devices with reverse interiors. For Male Devices Only.

FLUSH MOUNT	Part #
 01-2A142	

CORD GRIP with MESH	Part #
 see page 178	

MULTI-CONTACT REMOVAL TOOL	Part #
 61-CA593	

CRIMPER TOOL (GREENLEE OR EQUAL)	Part #
 4CN30	

EUROPEAN CRIMPING TOOL	Part #
 61-CA500	

MULTIPIN

DSN24c/DS24c Multipin Plugs & Receptacles – 7.5A

Ratings

- Voltage**
DSN24c
 50 VAC or 480 VAC Max/130 VDC*
* For DC order 480V model
DS24c
 Up to 250 VAC Max/130 VDC
- Amperage Rating**
 2A Current Interrupting
 7.5A Non-Current Interrupting
! DSN24c/DS24c is capable of handling 4-20mA low current applications
- Environmental Ratings**
 IP66/IP67 (Poly only)
 IP54/IP55 (Stainless Steel)
- Temperature Range**
 Min -40°F/Max 140°F
See pg 271 for temps below -15°F.
- Wiring Capacity**
 Min 18 AWG Max 14 AWG
- Certifications**
 UL Coming Soon!

For DSN24c dimensions, see pgs 36-37

Receptacle (female)



Inlet (male)



! Don't forget to add installation accessories to your order

North American Configurations

Voltage	Polarity	Part #		Part #	
		Poly	Stainless Steel	Poly	Stainless Steel
50V	24P	63-B4002	37-B4002-SS	63-B8002	37-B8002-SS
250V	23P+G	-	37-B4002-SS	-	37-B8002-SS
480V	23P+G	63-B4002	-	63-B8002	-

For international configurations and ratings (IEC, CE) visit meltric.com/international-catalog or contact customer service at 800.433.7642.

Main Options



Padlock Pawl

Mushroom Pawl

Self-Ejecting Devices

* Requires straight insertion receptacle or inlet and self-ejecting plug or connector

Receptacle Options

Suffix

Inlet Options

Suffix

Straight Insertion	Recept # - 352	Self-Ejecting Plug Release	Inlet # - 338
Self-Ejecting Connector Release	Recept # - 354		
Mushroom Pawl	Recept # - 375		
Padlock Pawl	Recept # - 843		
Padlockable Mushroom Pawl	Recept # - 375-843		
Closed Lid Configuration	Recept # - NC		

Poly Devices Only

! See pages 248-257 for detailed information on these options



Order Example: 480V DSN24c + mushroom pawl
 DSN24c 22P Poly receptacle = 63-B4002-375

INSTALLATION ACCESSORIES – SIZE 2

Unless indicated otherwise, accessories can be used with either poly or metal plugs and receptacles.

HANDLES

POLY HANDLE w/NPT		Part #	
	1/2"	512P0N05	Finger draw plates are recommended for easier connector closure on cord to cord assemblies.
	3/4"	512P0N07	
	1"	512P0N10	
	1 1/4"	512P0N12	

HANDLE w/CORD GRIP w/NPT	Poly	Metal
	.625 - .750"	712P0CP4 792P0CS4
	.770 - .875"	712P0DP2 792P0DS1
	.870 - 1.000"	712P0DP3 792P0DS3

STAINLESS STEEL HANDLE w/NPT		
	3/4"	7X2P0N07
	1"	7X2P0N10

NYLON HANDLE w/Cable Range		
	.20 - .83"	512P0D21

POLY HANDLE W/CLAMP & BUSHING w/Cable Range		
	.750 - .875"	712P0S14
	.875 - 1.000"	712P0S16
	1.000 - 1.125"	712P0S18
	1.125 - 1.250"	712P0S20
	1.250 - 1.375"	712P0S22

i

Cable Range	NPT	Cable Range	NPT
.312 - .625	1/2"	.660 - 1.000	1"
.438 - .812	3/4"	.875 - 1.375"	1 1/4"

NPT sizes are determined by the cable diameter and third party cord grip.

ANGLES

NYLON ANGLE		
	30°	512M3

METAL ANGLE		
	0°	592M0

	30°	592M3
---	-----	--------------

	FS/FD Box 30°	792M3FS	* Base measures approximately 4.2" x 2.7". Due to the variation in sizes of FS boxes, please verify that your FS box matches our dimensions, if not call Customer Service for other solutions.
---	---------------	----------------	--

STAINLESS STEEL ANGLE		
	30°	7X2M3

BOXES

POLY CONDUIT ENTRY w/NPT		Part #	
	30°	1/2"	512B3N05
	* 8.5 in ³	3/4"	512B3N07

POLY WALL BOX w/NPT			
	70°	1/2" - 1 1/4"	512C7000

70° poly boxes are not drilled. Contact customer service if factory drilled is required.
* Interior volume with receptacle installed.

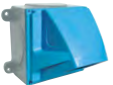
POLY ANGLE WITH ALUMINUM WALL BOX w/NPT			
	70°	1/2"	712C7N05
	70°	3/4"	712C7N07
	70°	1"	712C7N10
	70°	1 1/4"	712C7N12
	70°	1 1/2"	712C7N15

* Interior volume with receptacle installed.

METAL BOX w/NPT			
	0°	1/2"	7T1F0N05
	0°	3/4"	7T1F0N07
	0°	1"	7T1F0N10
	0°	1 1/4"	7T1F0N12

METAL BOX WITH NYLON ANGLE w/NPT			
	30°	1/2"	712C3N05
	30°	3/4"	712C3N07
	30°	1"	712C3N10
	30°	1 1/4"	712C3N12

For metal angle, replace "71" prefix with "79".
* Interior volume with receptacle installed.

STAINLESS STEEL BOX w/NPT			
	0°	1"	7X1F0N10

STAINLESS STEEL w/STAINLESS STEEL ANGLE w/NPT			
	30°	3/4"	7X2C3N07
	30°	1"	7X2C3N10

MISCELLANEOUS ACCESSORIES

FINGER DRAWPLATES		
	61-3A346	Set of Two (2) Recommended for cord to cord assembly applications, for easier connector closure.

PROTECTIVE CAP		
	61-3A426	For Male Devices Only.

PADLOCKABLE PLUG CAP		
	61-3A826	For Male Devices Only.

MULTI-CONTACT REMOVAL TOOL		
	61-CA593	

CRIMPER TOOL (GREENLEE OR EQUAL)		
	4CN30	

EUROPEAN CRIMPING TOOL		
	61-CA500	



MULTIPIN

DSN37c/DS37c Multipin Plugs & Receptacles – 7.5A

Ratings

- Voltage**
 Up to 480 VAC Max/130 VDC
- Amperage Rating**
 2A Current Interrupting
 7.5A Non-Current Interrupting
 ! DSN37c/DS37c is capable of handling 4-20mA low current applications
- Environmental Ratings**
 IP66/IP67 (Poly only)
 IP54/IP55 (Stainless Steel)
- Temperature Range**
 Min -40°F/Max 140°F
 See pg 271 for temps below -15°F.
- Wiring Capacity**
 Min 18 AWG Max 14 AWG
- Certifications**
 UL Coming Soon!

For DSN37c dimensions, see pgs 36-37

Receptacle (female)

Inlet (male)



! Don't forget to add installation accessories to your order

North American Configurations

Voltage	Polarity	Part #		Part #	
		Poly	Stainless Steel	Poly	Stainless Steel
50V	37P*	63-C4003	37-C4003-SS	63-C8003	37-C8003-SS
480V	36P+G*	63-C4003	37-C4003-SS	63-C8003	37-C8003-SS

For international configurations and ratings (IEC, CE) visit meltric.com/international-catalog or contact customer service at 800.433.7642.

Main Options



Padlock Pawl

Mushroom Pawl

Self-Ejecting Devices

* Requires straight insertion receptacle or inlet and self-ejecting plug or connector

Receptacle Options

Suffix

Inlet Options

Suffix

Straight Insertion	Recept # - 352	Self-Ejecting Plug Release	Inlet # - 338
Self-Ejecting Connector Release	Recept # - 354		
Mushroom Pawl	Recept # - 375		
Padlock Pawl	Recept # - 843		
Padlockable Mushroom Pawl	Recept # - 375-843		
Closed Lid Configuration	Recept # - NC		

Poly Devices Only

! See pages 248-257 for detailed information on these options



Order Example: 50V DSN37 + mushroom pawl
 DSN37c 32P Poly receptacle = 63-C4003-375

INSTALLATION ACCESSORIES – SIZE 3

Unless indicated otherwise, accessories can be used with either poly or metal plugs and receptacles.

HANDLES

POLY HANDLE w/NPT		Part #	Part #
	1/2"	513P0N05	Finger draw plates are recommended for easier connector closure on cord to cord assemblies. For available cord grips see pg 178.
	3/4"	513P0N07	
	1"	513P0N10	
	1 1/4"	513P0N12	

HANDLE w/CORD GRIP w/NPT		Poly	Metal
	.770 - .875"	713P0DP2	793P0DS1
	.875 - 1.000"	713P0DP3	793P0DS3
	1.000 - 1.125"	713P0EP2	793P0ES2

STAINLESS STEEL HANDLE w/NPT		Part #
	3/4"	7X3P0N07
	1"	7X3P0N10
	1 1/4"	7X3P0N12



NYLON HANDLE w/Cable Range		Part #
	.39 - 1.18"	513P0D30



POLY HANDLE W/CLAMP & BUSHING w/Cable Range		Part #
	.750 - .875"	713P0S14
	.875 - 1.000"	713P0S16
	1.000 - 1.125"	713P0S18
	1.125 - 1.250"	713P0S20
	1.250 - 1.375"	713P0S22

POLY HANDLE W/BUILT IN DRAW GRIPS w/Cable Range		Part #	Part #
	.35 - 1.25"	513P0D30473	Makes connector closures easier.

ANGLES

NYLON ANGLE		Part #
	30°	513M3

METAL ANGLE		Part #
	0°	593M0
	30°	593M3

FINGER DRAW PLATES		Part #	Part #
	FS/FD Box 30°	793M3FS	* Base measures approximately 4.2" x 2.7". Due to the variation in sizes of FS boxes, please verify that your FS box matches our dimensions, if not call Customer Service for other solutions.
	70°	593M7	

STAINLESS STEEL ANGLE		Part #
	30°	7X3M3

BOXES

POLY CONDUIT ENTRY w/NPT		Part #	Part #
	30° 1/2"	513B3N05	For poly devices only
	30° 3/4"	513B3N07	* Interior volume with receptacle installed.
	30° 1"	513B3N10	

POLY WALL BOX w/NPT		Part #	Part #
	70° 1/2" - 1 1/4"	513C7000	70° poly boxes are not drilled. Contact customer service if factory drilled is required. * Interior volume with receptacle installed.

POLY ANGLE WITH ALUMINUM WALL BOX w/NPT		Part #	Part #
	70° 1/2"	713C7N05	* Interior volume with receptacle installed.
	70° 3/4"	713C7N07	
	70° 1"	713C7N10	
	70° 1 1/4"	713C7N12	

METAL BOX w/NPT		Part #	Part #
	0° 1/2"	7T1F0N05	* Interior volume with receptacle installed.
	0° 3/4"	7T1F0N07	
	0° 1"	7T1F0N10	
	0° 1 1/4"	7T1F0N12	

METAL BOX WITH NYLON ANGLE w/NPT		Part #	Part #
	30° 1/2"	713C3N05	For metal angle, replace "71" prefix with "79". * Interior volume with receptacle installed.
	30° 3/4"	713C3N07	
	30° 1"	713C3N10	
	30° 1 1/4"	713C3N12	

STAINLESS STEEL BOX w/NPT		Part #
	0° 1"	7X1F0N10

STAINLESS STEEL w/STAINLESS STEEL ANGLE w/NPT		Part #
	30° 1"	7X3C3N10

MISCELLANEOUS ACCESSORIES

FINGER DRAWPLATES		Part #	Part #
	Set of Two (2) Recommended for cord to cord assembly applications, for easier connector closure.	61-6A346	

PROTECTIVE CAP		Part #	Part #
	For Male Devices Only.	61-6A426	

PADLOCKABLE PLUG CAP		Part #	Part #
	For Male Devices Only.	61-6A826	

MULTI-CONTACT REMOVAL TOOL		Part #
		61-CA593

CRIMPER TOOL (GREENLEE OR EQUAL)		Part #
		4CN30

EUROPEAN CRIMPING TOOL		Part #
		61-CA500



MULTIPIN

DN9c Multipin Plugs & Receptacles – 20A

Ratings

- Voltage**
 50 VAC or 480 VAC Max/130 VDC+
 + For DC order 480V model.
 Not CSA listed.
- Amperage Rating**
 20A Current Interrupting
- Horsepower Ratings**

120V	1Ø	1/3 hp
240V	1Ø	1 hp
208V	3Ø	2 hp
240V	3Ø	3 hp
480V	3Ø	5 hp
- Environmental Ratings**
 IP54/IP55
- Temperature Range**
 Min -40°F / Max 140°F
 See pg 271 for temps below -15°F.
- Wiring Capacity**
 Min 16 AWG Max 10 AWG
- Certifications**
 CSA 182.01

Receptacle (female)



Inlet (male)



! Don't forget to add installation accessories to your order

North American Configurations

Voltage	Polarity	Part # Metal	Part # Metal
50V	6P	17-14060	17-18060
50V	7P	17-14070	17-18070
50V	8P	17-14080	17-18080
50V	9P	17-14090	17-18090
480V	5P+G	17-14051	17-18051
480V	6P+G	17-14061	17-18061
480V	7P+G	17-14071	17-18071
480V	8P+G	17-14081	17-18081

For international configurations and ratings (IEC,CE) visit meltric.com/international-catalog or contact customer service at 800.433.7642.

Main Options



**Mushroom
Pawl**



Padlock Pawl

Receptacle Options

Suffix

Inlet Options

Suffix

Straight Insertion	Recept # - A188	Straight Insertion	Inlet # - A188
Self-Ejecting Connector Release	Recept # - 348-A188		
HP Watertightness (high pressure)	Recept # - HP		
Mushroom Pawl	Recept # - 375		
Locking Mushroom Pawl	Recept # - 845		
Padlock Pawl	Recept # - 843		
Padlockable Mushroom Pawl	Recept # - 375-843		
Closed Lid Configuration	Recept # - NC		





! See pages 248-257 for detailed information on these options



Order Example: 50V DN9c with Closed Lid Configuration
 DN9c Receptacle 9P = 17-14090-NC

INSTALLATION ACCESSORIES – SIZE 3

Unless indicated otherwise, accessories can be used with either poly or metal plugs and receptacles.





HANDLES

POLY HANDLE w/NPT		Part # Poly	Part # Metal
	1/2"	513P0N05	593P0N05
	3/4"	513P0N07	593P0N07
	1"	513P0N10	593P0N10
	1 1/4"	513P0N12	593P0N12

HANDLE w/CORD GRIP w/NPT	Poly	Metal
	.770 - .875"	713P0DP2 793P0DS1
	.875 - 1.000"	713P0DP3 793P0DS3
	1.000 - 1.125"	713P0EP2 793P0ES2

NYLON HANDLE w/Cable Range		
	.39 - 1.18"	513P0D30

Finger draw plates are recommended for easier connector closure on cord to cord assemblies.





POLY HANDLE W/CLAMP & BUSHING w/Cable Range		
	.750 - .875"	713P0S14
	.875 - 1.000"	713P0S16
	1.000 - 1.125"	713P0S18
	1.125 - 1.250"	713P0S20
	1.250 - 1.375"	713P0S22

POLY HANDLE W/BUILT IN DRAW GRIPS w/Cable Range		
	.39 - 1.18"	513P0D30473

Makes connector closures easier





For available cord grips, see pgs 178.





ANGLES

METAL ANGLE		
	0°	593M0
	30°	593M3
	FS/FD Box 30°	793M3FS
	70°	593M7

* Base measures approximately 4.2" x 2.7". Due to the variation in sizes of FS boxes, please verify that your FS box matches our dimensions, if not call Customer Service for other solutions.

BOXES

METAL BOX w/NPT			
	0°	1/2"	7T1F0N05
	0°	3/4"	7T1F0N07
	0°	1"	7T1F0N10
	0°	1 1/4"	7T1F0N12

METAL BOX WITH METAL ANGLE w/NPT			
	30°	1/2"	793C3N05
	30°	3/4"	793C3N07
	30°	1"	793C3N10
	30°	1 1/4"	793C3N12

* 30.1 in³

NPT on top or bottom (if rotated). For other NPT configurations, contact customer service.

i			
Cable Range	NPT	Cable Range	NPT
.312 - .625	1/2"	.660 - 1.000	1"
.438 - .812	3/4"	.875 - 1.375"	1 1/4"

NPT sizes are determined by the cable diameter and third party cord grip.

MISCELLANEOUS ACCESSORIES

FINGER DRAWPLATES		
	61-6A346	Set of Two (2) Recommended for cord to cord assembly applications, for easier connector closure.

PROTECTIVE NEOPRENE CAP		
	19-1A126	For Male Devices Only.

CORD GRIP with MESH		
	see pg 178	

RECEPTACLE LOCKING PIN		
	LP-843	Requires Padlockable Pawl option (-843) on receptacle.

DN20c Multipin Plugs & Receptacles – 20A

Ratings

- Voltage**
50 VAC or 480 VAC Max/130 VDC*
* For DC order 480V model.
Not CSA listed.
- Amperage Rating**
20A/15A Current Interrupting*
* The amperage rating is 15A when more than 12 contacts are used for power circuits (not control).
- Horsepower Ratings**

120V	1Ø	1/6 hp
240V	1Ø	1/2 hp
208V	3Ø	1 hp
240V	3Ø	1 hp
480V	3Ø	3 hp
- Environmental Ratings**
IP54/IP55
- Temperature Range**
Min -40°F/Max 140°F
See pg 271 for temps below -15°F.
- Wiring Capacity**
Min 16 AWG Max 10 AWG
- Certifications**
CSA 182.01

Receptacle (female)



Inlet (male)



* The amperage rating is 15A when more than 12 contacts are used for power circuits (not control).

! Don't forget to add installation accessories to your order

North American Configurations

Voltage	Polarity	Part # Metal	Part # Metal
50V	10P	17-64100	17-68100
50V	11P	17-64110	17-68110
50V	12P	17-64120	17-68120
50V	13P	17-64130*	17-68130*
50V	14P	17-64140*	17-68140*
50V	15P	17-64150*	17-68150*
50V	16P	17-64160*	17-68160*
50V	17P	17-64170*	17-68170*
50V	18P	17-64180*	17-68180*
50V	19P	17-64190*	17-68190*
50V	20P	17-64200*	17-68200*
480V	9P+G	17-64091	17-68091
480V	10P+G	17-64101	17-68101
480V	11P+G	17-64111	17-68111
480V	12P+G	17-64121	17-68121
480V	13P+G	17-64131*	17-68131*
480V	14P+G	17-64141*	17-68141*
480V	15P+G	17-64151*	17-68151*
480V	16P+G	17-64161*	17-68161*
480V	17P+G	17-64171*	17-68171*
480V	18P+G	17-64181*	17-68181*
480V	19P+G	17-64191*	17-68191*

For international configurations and ratings (IEC,CE) visit meltric.com/international-catalog or contact customer service at 800.433.7642.

Main Options



Mushroom Pawl



Self-Ejecting Devices

* Requires straight insertion receptacle or inlet and self-ejecting plug or connector

! See pages 248-257 for detailed information on these options

Receptacle Options

Suffix

Inlet Options

Suffix

Straight Insertion	Recept # - A188	Self-Ejecting Plug Release	Inlet # - 338-A188
Self-Ejecting Connector Release	Recept # - 348-A188	Straight Insertion	Inlet # - A188
HP Watertightness (high pressure)	Recept # - HP		
Mushroom Pawl	Recept # - 375		
Locking Mushroom Pawl	Recept # - 845		
Padlock Pawl	Recept # - 843		
Padlockable Mushroom Pawl	Recept # - 375-843		
180° Opening Lid	Recept # - 180		
Closed Lid Configuration	Recept # - NC		



Order Example: 50V DN20c with Closed Lid Configuration



DN20c Receptacle 19P = 17-64190-NC

INSTALLATION ACCESSORIES – SIZE 5

Unless indicated otherwise, accessories can be used with either poly or metal plugs and receptacles.

HANDLES

POLY HANDLE w/NPT		Part # Poly	Part # Metal
	3/4"	515P0N07	595P0N07
	1"	515P0N10	595P0N10
	1 1/4"	515P0N12	595P0N12
	1 1/2"	515P0N15	595P0N15
	2"	515P0N20	595P0N20

HANDLE w/CORD GRIP w/NPT	Poly	Metal
	1.270 - 1.470"	715P0EP3
	1.250 - 1.375"	-
	1.438 - 1.562"	795P0ES4
	1.562 - 1.688"	795P0FS2
	1.520 - 1.860"	715P0GP2
		-

POLY HANDLE W/CLAMP & BUSHING w/Cable Range	
	1.250 - 1.375" 715P0S22
	1.438 - 1.562" 715P0S25
	1.562 - 1.688" 715P0S27
	1.688 - 1.812" 715P0S29

SANTOPRENE™ HANDLE w/Cable Range	
	.70 - 1.00" 555P0D25
	1.00 - 1.375" 555P0D35
	1.375 - 1.750" 555P0D45

For available cord grips, see pg 178.

BOXES

METAL BOX w/NPT			
	0°	1 1/4"	7T5F0N12
	0°	1 1/2"	7T5F0N15
	0°	2"	7T5F0N20
	0°	2 1/2"	7T5F0N25

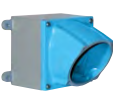
METAL BOX WITH METAL ANGLE w/NPT			
	30°	1 1/4"	795C3N12
	30°	1 1/2"	795C3N15
	30°	2"	795C3N20
* 118.9 in³	30°	2 1/2"	795C3N25



* Interior volume with receptacle installed.

NPT on top or bottom (if rotated). For other NPT configurations, contact customer service.

Cable Range	NPT	Cable Range	NPT
.438 - .812	3/4"	.890 - 1.812"	1 1/2"
.660 - 1.000	1"	1.190 - 2.438"	2"
.875 - 1.375"	1 1/4"		

NPT sizes are determined by the cable diameter and third party cord grip.

ANGLES

METAL ANGLE	
	0° 595M0
	30° 595M3
	70° 595M7

MISCELLANEOUS ACCESSORIES

PROTECTIVE NEOPRENE CAP	
	19-6A126 For Male Devices Only.

CORD GRIP with MESH	
	see pg 178

RECEPTACLE LOCKING PIN	
	LP-843 Requires Padlockable Pawl option (-843) on receptacle.

DS7c Multipin Plugs & Receptacles – 30A

UL/CSA Ratings

- **Voltage**
50 VAC or 600 VAC Max/130 VDC*
* For DC order 600V model
- **Amperage Rating**
30A Current Interrupting
- **Temperature Range**
Min -40°F/Max 140°F
See pg 271 for temps below -15°F.
- **Environmental Ratings**
IP54/IP55
- **Wiring Capacity**
Min 14 AWG Max 8 AWG
- **Certifications**
Contact Customer Service

For DS7c dimensions, see pgs 54-55

Receptacle (female)



Inlet (male)



! Don't forget to add installation accessories to your order

North American UL/CSA Configurations

Voltage	Polarity	Part #		Part #	
		Poly	Metal	Poly	Metal
50V	4P	33-34540	37-34540	33-38540	37-38540
50V	5P	33-34550	37-34550	33-38550	37-38550
50V	6P	33-34560	37-34560	33-38560	37-38560
50V	7P	33-34570	37-34570	33-38570	37-38570
600V	3P+G	33-34531	37-34531	33-38531	37-38531
600V	4P+G	33-34541	37-34541	33-38541	37-38541
600V	5P+G	33-34551	37-34551	33-38551	37-38551
600V	6P+G	33-34561	37-34561	33-38561	37-38561

For international configurations and ratings (IEC,CE) visit meltric.com/international-catalog or contact customer service at 800.433.7642.

Main Options



Mushroom Pawl



Padlock Pawl



Self-Ejecting Devices

* Requires straight insertion receptacle or inlet and self-ejecting plug or connector

Receptacle Options

Suffix

Inlet Options

Suffix

With 2 Auxiliary/Pilot Contacts	Recept # - 172	With 2 Auxiliary/Pilot Contacts	Inlet # - 172
With 3 Auxiliary/Pilot Contacts	Recept # - 173	With 3 Auxiliary/Pilot Contacts	Inlet # - 173
Type 4X & closed lid configuration	Recept # - 4X	Type 4X watertightness	Inlet # - 4X
Straight Insertion	Recept # - 352	Self-Ejecting Plug Release	Inlet # - 338
Self-Ejecting Connector Release	Recept # - 354	With No Lockout Hole	Inlet # - A155
Mushroom Pawl	Recept # - 375		
Padlock Pawl	Recept # - 843		
Padlockable Mushroom Pawl	Recept # - 375-843		
Locking Mushroom Pawl	Recept # - 845		
Metal Pawl (on poly receptacle)	Recept # - 824		
Closed Lid Configuration	Recept # - NC		

! See pages 248-257 for detailed information on these options





Order Example: 50V DS7c + mushroom pawl

DS7c Poly receptacle 4P = 33-34540-375





INSTALLATION ACCESSORIES – SIZE 4

Unless indicated otherwise, accessories can be used with either poly or metal plugs and receptacles.

HANDLES





HANDLE w/NPT	Part # Poly	Part # Metal
 1/2"	514P0N05	594P0N05
 3/4"	514P0N07	594P0N07
 1"	514P0N10	594P0N10
 1 1/4"	514P0N12	594P0N12
 1 1/2"	514P0N15	594P0N15

For metal devices only

HANDLE w/CORD GRIP	Cable Range	Poly	Metal
	1.270 - 1.470"	714P0EP3	-
	1.250 - 1.375"	-	794P0ES4
	1.438 - 1.562"	-	794P0FS2
	1.562 - 1.688"	-	794P0FS3

For metal devices only

NYLON HANDLE w/Cable Range		
	.51 - 1.38"	514P0D35

POLY HANDLE W/CLAMP & BUSHING w/Cable Range		
	1.250 - 1.375"	714P0S22
	1.438 - 1.562"	714P0S25
	1.562 - 1.688"	714P0S27
	1.688 - 1.812"	714P0S29







POLY HANDLE W/BUILT IN DRAW GRIPS w/Cable Range		
	.51 - 1.38"	514P0D35473

Makes connector closures easier.

For available cord grips, see pg 178.

For a guideline of NPT based cable ranges, see DS60 on pg 45.

ANGLES

NYLON ANGLE		
	30°	514M3
METAL ANGLE		
	0°	594M0
	30°	594M3
	30°	794M3L
	Oversized 30°	794M3
	70°	594M7

Mounts on oversize box only. Order with 7T5FDNxx. See pg 49.

BOXES

POLY CONDUIT ENTRY w/NPT			
	30°	1/2"	514B3N05
	30°	3/4"	514B3N07
	30°	1"	514B3N10
	30°	1 1/4"	514B3N12

* 28.1 in³

For poly devices only

* Interior volume with receptacle installed.

POLY WALL BOX w/NPT			
	70°	1/2" - 2"	514C7000

* 181.24 in³

70° poly boxes are not drilled. Contact customer service if factory drilled is required.

* Interior volume with receptacle installed.

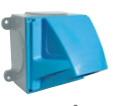
POLY ANGLE WITH ALUMINUM WALL BOX w/NPT			
	70°	1/2"	714C7N05
	70°	3/4"	714C7N07
	70°	1"	714C7N10
	70°	1 1/4"	714C7N12
	70°	1 1/2"	714C7N15

* 170.0 in³

* Interior volume with receptacle installed.

METAL BOX w/NPT			
	0°	1"	7T4F0N10
	0°	1 1/4"	7T4F0N12
	0°	1 1/2"	7T4F0N15
	0°	2"	7T4F0N20

METAL BOX WITH NYLON ANGLE w/NPT			
	30°	1"	714C3N10
	30°	1 1/4"	714C3N12
	30°	1 1/2"	714C3N15
	30°	2"	714C3N20

* 61.0 in³ Nylon Angle

* 59.9 in³ Metal Angle

For metal angle, replace "71" prefix with "79".

* Interior volume with receptacle installed.

NPT on top or bottom (if rotated). For other NPT configurations, contact customer service.

MISCELLANEOUS ACCESSORIES

FINGER DRAWPLATES		
	31-6A346	Set of Two (2) Recommended for cord to cord assembly applications, for easier connector closure.

PROTECTIVE CAP		
	31-6A426	For Male Devices Only.

PADLOCKABLE PLUG CAP		
	DS6MC	Aluminum – For Male Devices Only.

INLET SPRING-LOADED CAP		
	31-6A226	

EASY RETROFIT ADAPTER PLATES		
	see pg 175	Mount to existing boxes.

RECEPTACLE LOCKING PIN		
	LP-843	Requires Padlockable Pawl option (-843) on receptacle.

DR7c Multipin Plugs & Receptacles – 50A

UL/CSA Ratings

- **Voltage**
50 VAC or 600 VAC Max/130 VDC*
* For DC order 600V model
- **Amperage Rating**
50A Non-Current Interrupting
- **Temperature Range**
Min -40°F/Max 140°F
See pg 271 for temps below -15°F.
- **Environmental Ratings**
IP54/IP55
- **Wiring Capacity**
Min 14 AWG Max 8 AWG
- **Certifications**
Contact Customer Service

For DRc dimensions, see pgs 112-113

Receptacle (female)



Inlet (male)



! Don't forget to add installation accessories to your order

North American UL/CSA Configurations

Voltage	Polarity	Part #		Part #	
		Poly	Metal	Poly	Metal
50V	4P	31-34940	39-34940	31-38940	39-38940
50V	5P	31-34950	39-34950	31-38950	39-38950
50V	6P	31-34960	39-34960	31-38960	39-38960
50V	7P	31-34970	39-34970	31-38970	39-38970
600V	3P+G	31-34931	39-34931	31-38931	39-38931
600V	4P+G	31-34941	39-34941	31-38941	39-38941
600V	5P+G	31-34951	39-34951	31-38951	39-38951
600V	6P+G	31-34961	39-34961	31-38961	39-38961

For international configurations and ratings (IEC, CE) visit meltric.com/international-catalog or contact customer service at 800.433.7642.

Main Options



Mushroom Pawl



Padlock Pawl



Self-Ejecting Devices

* Requires straight insertion receptacle or inlet and self-ejecting plug or connector

Receptacle Options

Suffix

Inlet Options

Suffix

With 2 Auxiliary/Pilot Contacts	Recept # - 172	With 2 Auxiliary/Pilot Contacts	Inlet # - 172
With 3 Auxiliary/Pilot Contacts	Recept # - 173	With 3 Auxiliary/Pilot Contacts	Inlet # - 173
Type 4X & closed lid configuration	Recept # - 4X	Type 4X watertightness	Inlet # - 4X
Straight Insertion	Recept # - 352	Self-Ejecting Plug Release	Inlet # - 338
Self-Ejecting Connector Release	Recept # - 354	With No Lockout Hole	Inlet # - A155
Mushroom Pawl	Recept # - 375		
Padlock Pawl	Recept # - 843		
Padlockable Mushroom Pawl	Recept # - 375-843		
Locking Mushroom Pawl	Recept # - 845		
Metal Pawl (on poly receptacle)	Recept # - 824		
Closed Lid Configuration	Recept # - NC		

! See pages 248-257 for detailed information on these options





Order Example: 50V DR7c + mushroom pawl

DR7c Poly receptacle 4P = 31-34940-375





INSTALLATION ACCESSORIES – SIZE 4

Unless indicated otherwise, accessories can be used with either poly or metal plugs and receptacles.

HANDLES





HANDLE w/NPT	Part # Poly	Part # Metal
 1/2"	514P0N05	594P0N05
 3/4"	514P0N07	594P0N07
 1"	514P0N10	594P0N10
 1 1/4"	514P0N12	594P0N12
 1 1/2"	514P0N15	594P0N15

For metal devices only

HANDLE w/CORD GRIP	Cable Range	Poly	Metal
 1.270 - 1.470"	714P0EP3	-	-
 1.250 - 1.375"	-	-	794P0ES4
 1.438 - 1.562"	-	-	794P0FS2
 1.562 - 1.688"	-	-	794P0FS3

For metal devices only

NYLON HANDLE w/Cable Range		
 .51 - 1.38"	514P0D35	







POLY HANDLE W/CLAMP & BUSHING w/Cable Range		
 1.250 - 1.375"	714P0S22	
 1.438 - 1.562"	714P0S25	
 1.562 - 1.688"	714P0S27	
 1.688 - 1.812"	714P0S29	

POLY HANDLE W/BUILT IN DRAW GRIPS w/Cable Range		
 .51 - 1.38"	514P0D35473	Makes connector closures easier.





For available cord grips, see pg 178.

For a guideline of NPT based cable ranges, see DS60 on pg 45.

ANGLES

NYLON ANGLE		
 30°	514M3	
METAL ANGLE		
 0°	594M0	
 30°	594M3	
 30°	794M3L	
 Oversized 30°	794M3	Mounts on oversize box only. Order with 7T5FDNxx. See pg 49.
 70°	594M7	

BOXES

POLY CONDUIT ENTRY w/NPT			Part #
 30°	1/2"		514B3N05
 30°	3/4"		514B3N07
 30°	1"		514B3N10
 30°	1 1/4"		514B3N12

* 28.1 in³

For poly devices only





* Interior volume with receptacle installed.

POLY WALL BOX w/NPT			Part #
 70°	1/2" - 2"		514C7000

* 181.24 in³



70° poly boxes are not drilled. Contact customer service if factory drilled is required.





* Interior volume with receptacle installed.

POLY ANGLE WITH ALUMINUM WALL BOX w/NPT			Part #
 70°	1/2"		714C7N05
 70°	3/4"		714C7N07
 70°	1"		714C7N10
 70°	1 1/4"		714C7N12
 70°	1 1/2"		714C7N15

* 170.0 in³

* Interior volume with receptacle installed.

METAL BOX w/NPT			Part #
 0°	1"		7T4F0N10
 0°	1 1/4"		7T4F0N12
 0°	1 1/2"		7T4F0N15
 0°	2"		7T4F0N20

METAL BOX WITH NYLON ANGLE w/NPT			Part #
 30°	1"		714C3N10
 30°	1 1/4"		714C3N12
 30°	1 1/2"		714C3N15
 30°	2"		714C3N20

* 61.0 in³ Nylon Angle







* 59.9 in³ Metal Angle

For metal angle, replace "71" prefix with "79".

* Interior volume with receptacle installed.

NPT on top or bottom (if rotated). For other NPT configurations, contact customer service.

MISCELLANEOUS ACCESSORIES

FINGER DRAWPLATES		
 31-6A346	Set of Two (2) Recommended for cord to cord assembly applications, for easier connector closure.	
PROTECTIVE CAP		
 31-6A426	For Male Devices Only.	
PADLOCKABLE PLUG CAP		
 DS6MC	Aluminum – For Male Devices Only.	
INLET SPRING-LOADED CAP		
 31-6A226		
EASY RETROFIT ADAPTER PLATES		
 see pg 175	Mount to existing boxes.	
RECEPTACLE LOCKING PIN		
 LP-843	Requires Padlockable Pawl option (-843) on receptacle.	

PN7c/DN9c SPARE PARTS Male Configuration

PN7c pictured



DN9c pictured

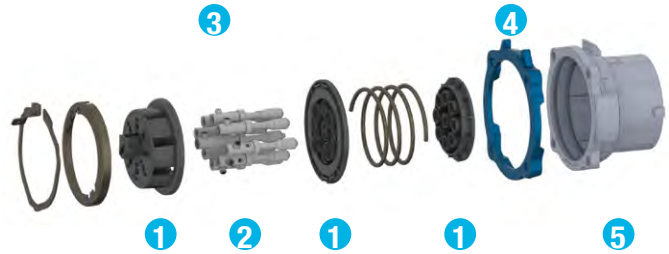

	DSN24c POLY	DSN37c POLY	DS7c/ DR7c POLY	DS7c/ DR7c METAL
Plug Interior	61-BA910	61-CA910	31-6A014	39-6A014
Plug Contact (Qty = 13)*	61-BA113	61-CA113	31-3A911	31-3A911
Plug Ground Contact (Qty = 13)*	61-BA113	61-CA113	31-3A911-172	31-3A911-172
Plug Casing**	61-3A105	61-6A105	31-3A910-263	31-3A910-263
Device Gasket	61-3AM26	31-3AM26	31-6AM26	31-6AM26
Stainless Steel Casing	39-1A014-SS	39-3A014-SS	31-3A919	31-3A919
Interior for Stainless Plug	61-BA910-SS	-		

* If a DSN24c or 37c device was originally purchased before February 2013, contact customer service for parts.

** If a DSN24c or 37c device was originally purchased before March 2015, contact customer service for casing parts.

	PN7c POLY	PN7c METAL	PN12c POLY	PN12c METAL
1 Plug Interior, Ground Contact & Connection	01-PA910	09-PA910	01-AA910	09-AA910
2 Plug Contact (PN12c Qty = 13)*	09-PA911	09-PA911	01-AA113	01-AA113
3 Device Gasket	61-1AM26	61-1AM26	61-1AM26	61-1AM26
4 Plug Casing	01-NA014	09-NA014	01-NA014	09-NA014
5 Ground Contact (PN12c Qty = 13)*	09-PA919	09-PA919	01-AA113	01-AA113

* If the PN12c device was purchased before March 2013, contact customer service for parts.

	DN9c METAL	DN20c METAL
1 Plug Interior	19-1A910	19-6A910
2 Plug Contact (Short/Outside)	19-1A911	19-6A911
2 Device Gasket (Long/Inside)	19-1A711	19-6A711
3 Plug Ground Contact	19-1A919	19-6A919
4 Plug Casing	19-1A014	19-6A014
5 Device Gasket	31-3A026	31-9A026

PN7c/DN9c SPARE PARTS Female Configuration

PN7c pictured



DN9c pictured



	DSN24c POLY	DSN37c POLY	DS7c/ DR7c POLY	DS7c/ DR7c METAL
Receptacle Interior	61-BA920	61-CA920	Receptacle Casing	31-6A024
Receptacle Contact (Qty = 13)*	61-BA213	61-CA213	Receptacle Phase Contact	31-3A921
Receptacle Ground Contact (Qty = 13)*	61-BA213	61-CA213	Receptacle Pilot Contact	31-3A921-172
Receptacle Casing**	61-3A305	61-6A305	Receptacle Interior	31-3A920-263
Device Gasket	61-3AM26	31-3AM26	Device Gasket	31-6AM26
Stainless Steel Casing	39-1A024-SS	39-3A024-SS	Ground Contact	31-3A929
Interior for Stainless Receptacle	61-BA920-SS	-		

* If the DSN24c or 37c device was originally purchased before February 2013, contact customer service for parts.

** If the DSN24c or 37c device was originally purchased before March 2015, contact customer service for casing parts.

	PN7c POLY	PN7c METAL	PN12c POLY	PN12c METAL
1 Receptacle Interior & Retaining Ring	01-PA920	09-PA920	01-AA920	09-AA920
2 Receptacle Contact (PN12c Qty = 13)*	09-PA921	09-PA921	31-CA213	31-CA213
3 Device Gasket	61-1AM26	61-1AM26	61-1AM26	61-1AM26
4 Receptacle Casing	01-NA024	09-NA024	01-NA024	09-NA024
5 Ground Contact (PN12c Qty = 13)*	09-PA929	09-PA929	31-CA213	31-CA213

* If the PN12c device was purchased before March 2013, contact customer service for parts.

	DN9c METAL	DN20c METAL
1 Receptacle Interior	19-1A920	19-6A920
2 Receptacle Contact (Short/Outside)	19-1A921	19-6A921
2 Receptacle Contact (Long/Inside)	19-1A721	19-6A721
3 Receptacle Ground Contact	19-1A929	19-6A929
4 Receptacle Casing	19-1A024	19-6A024
5 Lid, Gasket, Roll Pin & Spring	19-1A925	19-6A925
6 Device Gasket	31-3A026	31-9A026

DN DIMENSIONS Inlet – Provided in inches

Dimensions are for reference only and may change depending on accessories used. For precise dimensions contact MELTRIC Engineering.

Plug

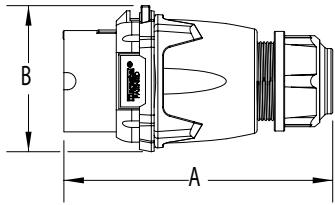

Inlet

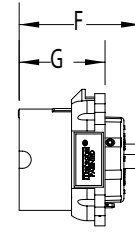
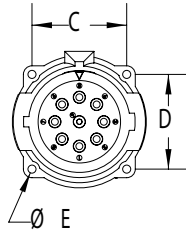

PRODUCT	A	B	C	D	ØE	F	G
DN9c	5.79	3.39	2.19	2.19	0.2	2.6	2.01
DN20c	10.75	4.92	3.2	3.2	0.24	4.48	3.5

Connector

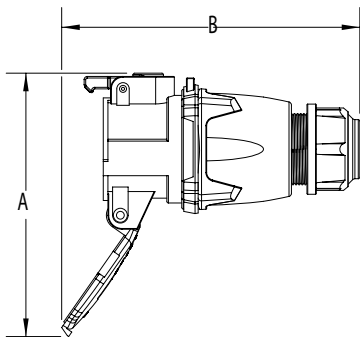

Receptacle

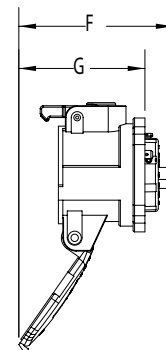
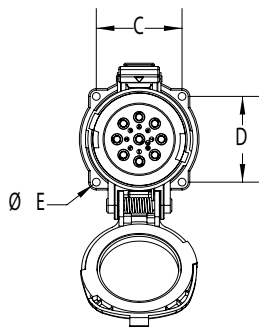

PRODUCT	A	B	C	D	E	F	G
DN9c	3.86	7.55	2.19	2.19	0.2	5.51	4.92
DN20c	5.2	12.12	3.2	3.2	0.24	6.14	7.68



Connector/Plug

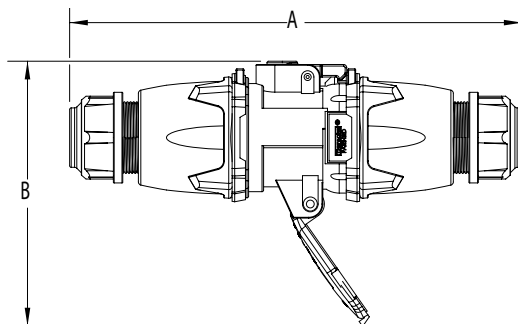

PRODUCT	A	B
DN9c	11.4	6.67
DN20c	17.25	7.34

Box/30° Angle/ Receptacle/Plug

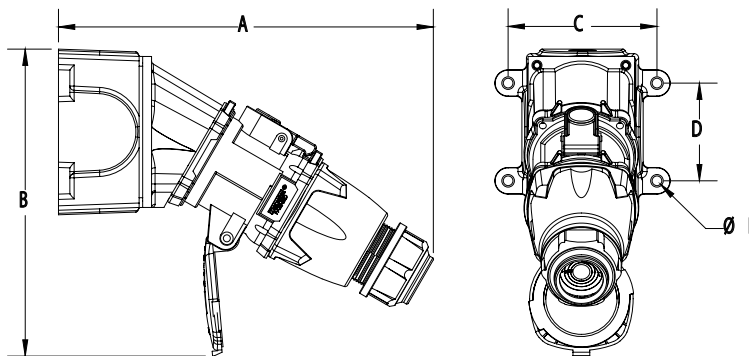

PRODUCT	A	B	C	D	øE
DN9c	10.55	8.64	4.19	2.75	0.27
DN20c	16.34	10.75	6.75	4.25	0.31



STANDARD DUTY

Plugs & Receptacles

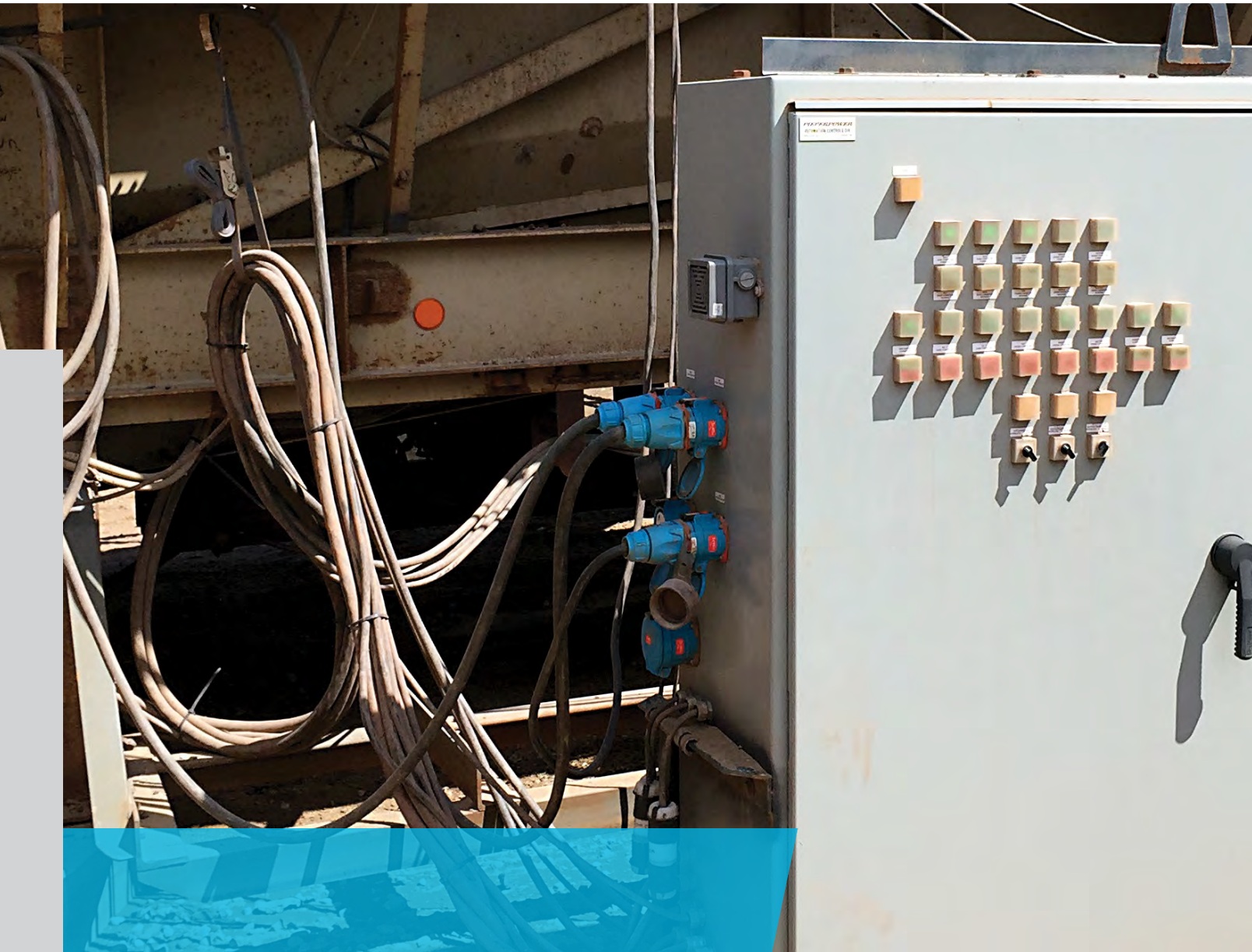

MELTRIC's Standard Duty plugs and receptacles provide safe, economical and robust connections for applications up to 400A. Each device features MELTRIC's spring-loaded, silver-nickel butt-style contacts for consistent and reliable connections. Exclusive safety features ensure operator safety.



DR P. 96

LARGER AMPERAGE RANGE

- 30A to 400A, Type 3R
- Poly or metal casings (most sizes)
- Larger conductor capacities



PN P. 114

COMPACT & DURABLE

- 15A to 20A
- Up to 600V



PNHT P.122

HIGH TEMPERATURE APPLICATIONS

- Temperatures up to 465°F
- Up to 30A, 480V, IP44

DR Standard Duty plug and receptacle

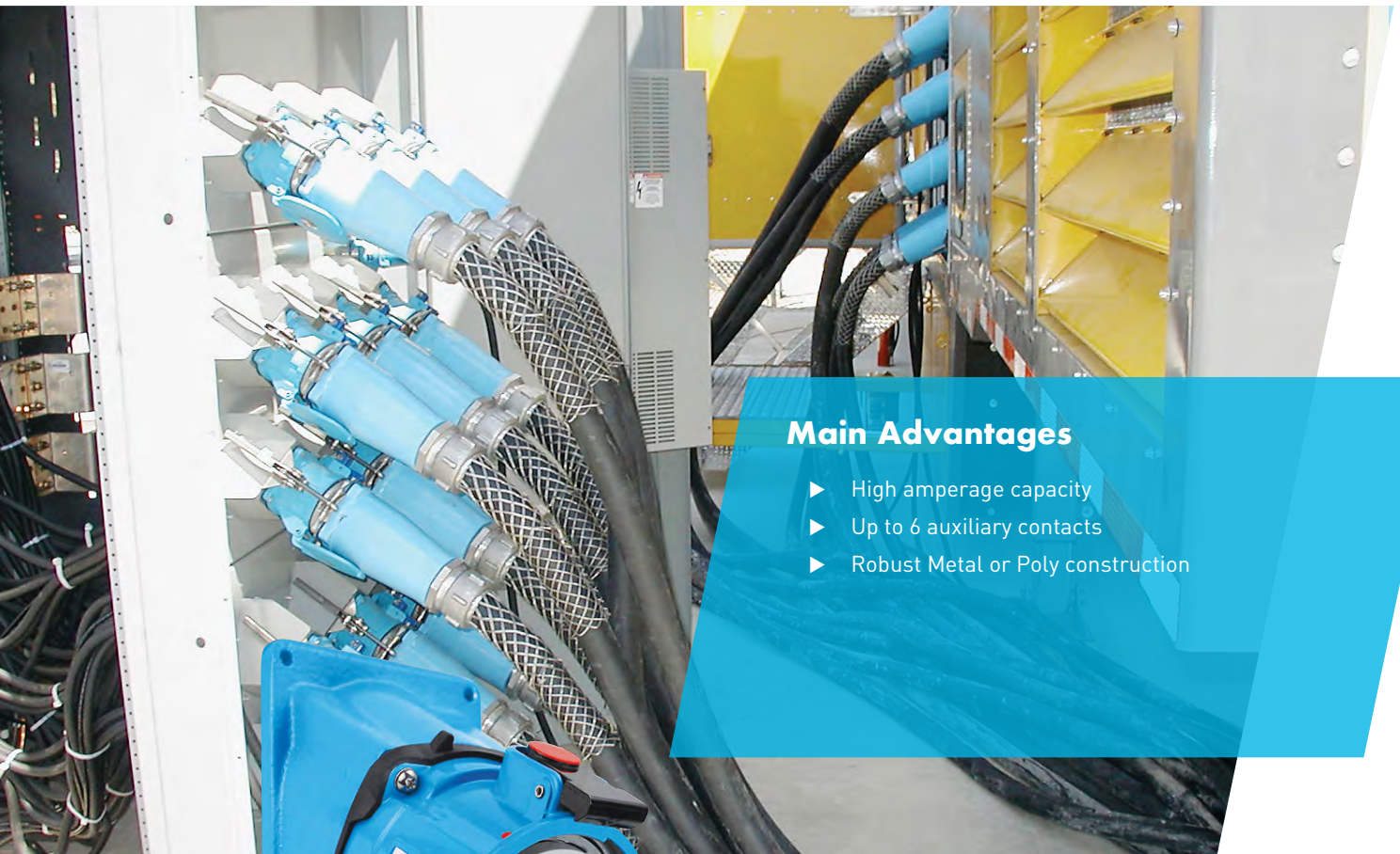

Main Advantages

- ▶ High amperage capacity
- ▶ Up to 6 auxiliary contacts
- ▶ Robust Metal or Poly construction



- | | | | |
|------------------------|--------|---------------|--------|
| ▶ Features and Ratings | p. 97 | ▶ DR250 | p. 106 |
| ▶ DR30 | p. 98 | ▶ DR400 | p. 108 |
| ▶ DR50 | p. 100 | ▶ Spare parts | p. 110 |
| ▶ DR100 | p. 102 | ▶ Dimensions | p. 112 |
| ▶ DR150 | p. 104 | | |

PRODUCT FEATURES

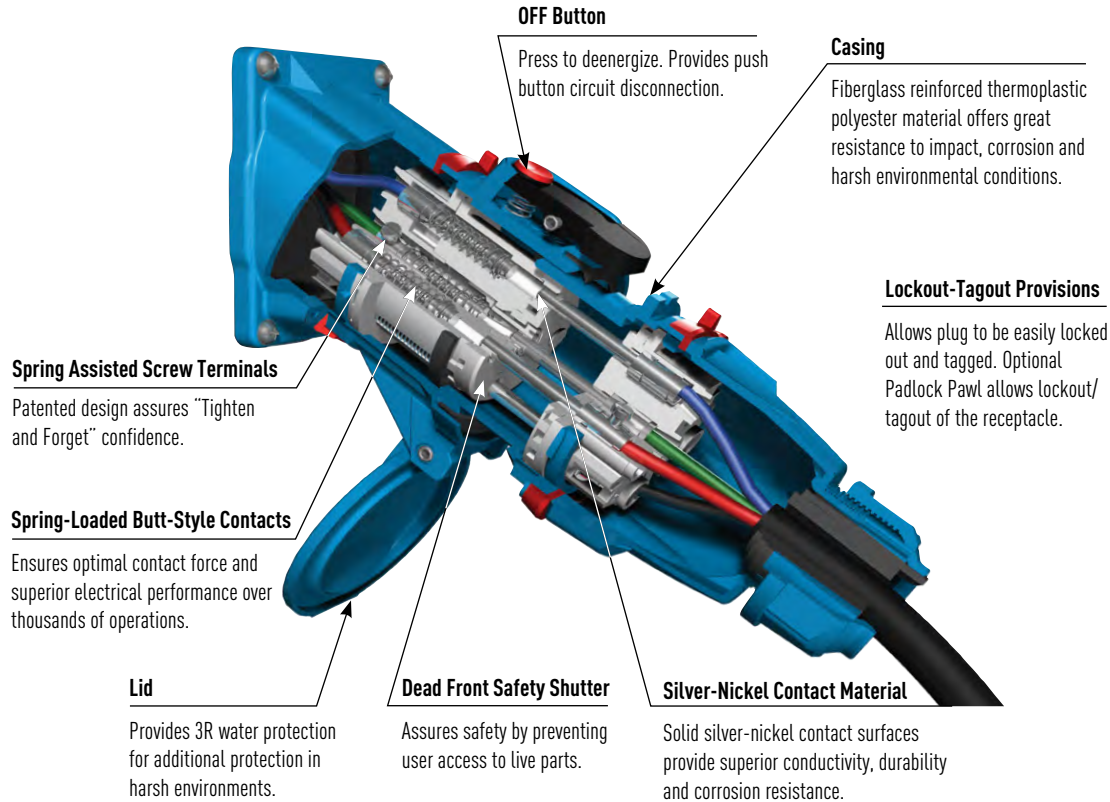

General Ratings

Amperage	30 to 400A
Voltage	600 VAC
Frequency	50-400 Hz
Short-Circuit (Make & Withstand)	10kA to 100kA*
Environmental	Type 3R, Type 4X optional
Temperature	min -40°F/max 140°F

* DR30, 50 & 100 are rated 100kA; DR150, 250 and 400 are 10kA to 65kA. Testing was performed with RK1 current limiting fuses sized at least 100% of the devices ampacity rating.

Current Interruption Listings

Model	Current Interruption Capabilities
DR30	Not for current interrupting
DR50	For current interrupting up to 250 VAC***
DR100	For current interrupting up to 250 VAC***
DR150	For current interrupting up to 250 VAC***
DR250	Not for current interrupting
DR400	Not for current interrupting

*** Devices rated for current interrupting are not intended for repetitive switching duties.

Listings

Category	UL	CSA	IEC
Plugs and Receptacles	UL 1682	C22.2 No. 182.1	60309-1

CE ratings available upon request.

Operating Instructions



When the plug and receptacle are latched together, the circuit is connected.



Pressing the pawl breaks the connection and opens the circuit. The plug is ejected to its rest position; The contacts are now dead.



Rotating the 'dead' plug 30° counterclockwise closes the safety shutter and frees the plug to be withdrawn from the receptacle.



The plug and the receptacle are separated. The safety shutter prevents access to live parts.

5 To reconnect, insert plug into receptacle, rotate 30° clockwise, and apply insertion force.

DR30 Standard Duty Plugs & Receptacles – 30A

UL/CSA Ratings

- **Max Amperage & Voltage**
30A, 600 VAC
- **Current Interruption Capability**
Not for current interrupting
 For Switch-Rated devices, see DS & DSN sections.
- **Short Circuit Rating**
100kA
Testing was performed with RK1 current limiting fuses sized at least 100% of the devices ampacity rating.
- **Environmental Ratings**
Type 3R (Standard)
Type 4X (Optional)
- **Temperature Range**
Min -40°F/Max 140°F
See pg 271 for temps below -15°F.
- **Wiring Capacity**
Min 14 AWG Max 8 AWG
Aux Contacts - Max 14 AWG
Based on THHN wire sizes
- **Certifications**
UL 1682, CSA 182.1

Receptacle (female)



Inlet (male)



! Don't forget to add installation accessories to your order

North American UL/CSA Configurations

Voltage	Polarity	Part # Poly	Part # Poly
120V	1P+N+G	31-14235-K16	31-18235-K16
120 208V	3P+N+G	31-14237-K16	31-18237-K16
125V	1P+N+G	31-14175-K07	31-18175-K07
125 250V	2P+N+G	31-14176-K07	31-18176-K07
208V	2P+G	31-14232-K16	31-18232-K16
208V	3P+G	31-14233-K16	31-18233-K16
250V	2P+G	31-14172-K07	31-18172-K07
250V	3P+G	31-14173-K07	31-18173-K07
277V	1P+N+G	31-14245-K04	31-18245-K04
277 480V	3P+N+G	31-14247-K04	31-18247-K04
347 600V	3P+N+G	31-14187-K14	31-18187-K14
480V	2P+G	31-14242-K04	31-18242-K04
480V	3P+G	31-14243-K04	31-18243-K04
600V	2P+G	31-14182-K14	31-18182-K14
600V	3P+G	31-14183-K14	31-18183-K14

For international configurations and ratings (IEC, CE) visit meltric.com/international-catalog or contact customer service at 800.433.7642.

Main Options



Auxiliary/Pilot Contacts



Mushroom Pawl



Padlock Pawl



Closed Lid Configuration

Recommended for cord applications to keep lid tucked in to avoid damage.

Receptacle Options

Suffix

Inlet Options

Suffix

With 2 Auxiliary/Pilot Contacts	Recept # - 972	With 2 Auxiliary/Pilot Contacts	Inlet # - 972
Type 4X & closed lid configuration	Recept # - 4X	Type 4X watertightness	Inlet # - 4X
Mushroom Pawl	Recept # - 375	With No Lockout Hole	Inlet # - A155
Padlock Pawl	Recept # - 843	For Auxiliary Switch*	Inlet # - NNF
Padlockable Mushroom Pawl	Recept # - 375-843		
Locking Mushroom Pawl	Recept # - 845		
Metal Pawl (on poly receptacle)	Recept # - 824		
Closed Lid Configuration	Recept # - NC		
With Auxiliary Switch	Recept # - 270+		

Notes: * Order inlet with P+N+G configuration and receptacle with P+G configuration.

Notes: + Not UL/CSA listed.





! See pages 248-257 for detailed information on these options





Order Example: 480V DR30 + 2 auxiliary contacts
DR30 Poly inlet 3P+G = 31-18243-K04-972

INSTALLATION ACCESSORIES – SIZE 2





Unless indicated otherwise, accessories can be used with either poly or metal plugs and receptacles.

HANDLES

HANDLE w/NPT	Part # Poly	Part # Metal
 1/2"	512P0N05	592P0N05
 3/4"	512P0N07	592P0N07
 1"	512P0N10	592P0N10
 1 1/4"	512P0N12	-

HANDLE w/CORD GRIP	Cable Range	Poly	Metal
	.438 - .500"	712P0BP3	792P0BS3
	.500 - .562"	712P0BP4	792P0BS4
	.562 - .625"	712P0BP5	792P0BS5
	.625 - .750"	712P0CP4	792P0CS4

NYLON HANDLE w/Cable Range	Part #
 .20 - .82"	512P0D21

POLY HANDLE W/CLAMP & BUSHING w/Cable Range	Part #
 .750 - .875"	712P0S14
 .875 - 1.000"	712P0S16
 1.000 - 1.125"	712P0S18
 1.125 - 1.250"	712P0S20
 1.250 - 1.375"	712P0S22

For available cord grips, see pgs 178.

Cable Range	NPT	Cable Range	NPT
.312 - .625	1/2"	.660 - 1.000	1"
.438 - .812	3/4"	.875 - 1.375"	1 1/4"

NPT sizes are determined by the cable diameter and third party cord grip.

ANGLES

NYLON ANGLE	Angle	Part #
 30°	30°	512M3



METAL ANGLE	Angle	Part #
 0°	0°	592M0

METAL ANGLE	Angle	Part #
 30°	30°	592M3

METAL ANGLE	Angle	Part #
 FS/FD Box 30°	FS/FD Box 30°	792M3FS

* Base measures approximately 4.2" x 2.7". Due to the variation in sizes of FS boxes, please verify that your FS box matches our dimensions, if not call Customer Service for other solutions.





BOXES

POLY CONDUIT ENTRY w/NPT	Angle	NPT	Part #	Volume
 30°	30°	1/2"	512B3N05	* 7.0 in ³
 30°	30°	3/4"	512B3N07	





For poly devices only
* Interior volume with receptacle installed.





POLY WALL BOX w/NPT	Angle	NPT	Part #	Volume
 70°	70°	1/2" - 1 1/4"	512C7000	* 82.0 in ³

70° poly boxes are not drilled. Contact customer service if factory drilling is required.
* Interior volume with receptacle installed.

POLY ANGLE WITH ALUMINUM WALL BOX w/NPT	Angle	NPT	Part #	Volume
 70°	70°	1/2"	712C7N05	* 75.0 in ³
 70°	70°	3/4"	712C7N07	
 70°	70°	1"	712C7N10	
 70°	70°	1 1/4"	712C7N12	
 70°	70°	1 1/2"	712C7N15	

* Interior volume with receptacle installed.

METAL BOX w/NPT	Angle	NPT	Part #
 0°	0°	1/2"	7T1F0N05
 0°	0°	3/4"	7T1F0N07
 0°	0°	1"	7T1F0N10
 0°	0°	1 1/4"	7T1F0N12

METAL BOX WITH NYLON ANGLE w/NPT	Angle	NPT	Part #	Volume
 30°	30°	1/2"	712C3N05	* 28.7 in ³
 30°	30°	3/4"	712C3N07	
 30°	30°	1"	712C3N10	
 30°	30°	1 1/4"	712C3N12	

For metal angle, replace "71" prefix with "79".
* Interior volume with receptacle installed.

NPT on top or bottom (if rotated). For other NPT configurations, contact customer service.

MISCELLANEOUS ACCESSORIES

FINGER DRAWPLATES	Part #	Description
	61-3A346	Set of Two (2) Recommended for cord to cord assembly applications, for easier connector closure.

PROTECTIVE CAP	Part #	Description
	31-1A426	For Male Devices Only.

PADLOCKABLE PLUG CAP	Part #	Description
	DS1PC	For Male Devices Only.

INLET SPRING-LOADED CAP	Part #
	31-1A226

EASY RETROFIT ADAPTER PLATES	Part #	Description
	see pg 175	Mount to existing boxes.

RECEPTACLE LOCKING PIN	Part #	Description
	LP-843	Requires Padlockable Pawl option (-843) on receptacle.

DR50 Standard Duty Plugs & Receptacles – 50A

UL/CSA Ratings

- **Max Amperage & Voltage**
50A, 600 VAC
- **Current Interruption Capability**
For current interrupting up to 250 VAC
 For Switch-Rated devices, see DS & DSN sections.
- **Short Circuit Rating**
100kA
Testing was performed with RK1 current limiting fuses sized at at least 100% of the devices ampacity rating.
- **Environmental Ratings**
Type 3R (Standard)
Type 4X (Optional)
- **Temperature Range**
Min -40°F / Max 140°F
See pg 271 for temps below -15°F.
- **Wiring Capacity**
Min 14 AWG Max 4 AWG
Aux Contacts - Max 14 AWG
Based on THHN wire sizes
- **Certifications**
UL 1682, CSA 182.1

Receptacle (female)



Inlet (male)



 Don't forget to add installation accessories to your order

North American UL/CSA Configurations

Voltage	Polarity	Part # Poly	Part # Poly
120V	1P+N+G	31-34235-K16	31-38235-K16
120 208V	3P+N+G	31-34237-K16	31-38237-K16
125V	1P+N+G	31-34175-K07	31-38175-K07
125 250V	2P+N+G	31-34176-K07	31-38176-K07
208V	2P+G	31-34232-K16	31-38232-K16
208V	3P+G	31-34233-K16	31-38233-K16
250V	2P+G	31-34172-K07	31-38172-K07
250V	3P+G	31-34173-K07	31-38173-K07
277V	1P+N+G	31-34245-K04	31-38245-K04
277 480V	3P+N+G	31-34247-K04	31-38247-K04
347 600V	3P+N+G	31-34187-K14	31-38187-K14
480V	2P+G	31-34242-K04	31-38242-K04
480V	3P+G	31-34243-K04	31-38243-K04
600V	2P+G	31-34182-K14	31-38182-K14
600V	3P+G	31-34183-K14	31-38183-K14

For international configurations and ratings (IEC, CE) visit meltric.com/international-catalog or contact customer service at 800.433.7642.

Main Options



Auxiliary/Pilot Contacts



Mushroom Pawl



Padlock Pawl



Closed Lid Configuration

Recommended for cord applications to keep lid tucked in to avoid damage.

Receptacle Options

Suffix

Inlet Options

Suffix

With 2 Auxiliary/Pilot Contacts	Recept # - 972	With 2 Auxiliary/Pilot Contacts	Inlet # - 972
With 3 Auxiliary/Pilot Contacts	Recept # - 973	With 3 Auxiliary/Pilot Contacts	Inlet # - 973
With 4 Auxiliary/Pilot Contacts	Recept # - 974	With 4 Auxiliary/Pilot Contacts	Inlet # - 974
Type 4X & closed lid configuration	Recept # - 4X	Type 4X watertightness	Inlet # - 4X
Mushroom Pawl	Recept # - 375	With No Lockout Hole	Inlet # - A155
Padlock Pawl	Recept # - 843	For Auxiliary Switch*	Inlet # - NNF
Padlockable Mushroom Pawl	Recept # - 375-843		
Locking Mushroom Pawl	Recept # - 845		
Metal Pawl (on poly receptacle)	Recept # - 824		
Closed Lid Configuration	Recept # - NC		
With Auxiliary Switch	Recept # - 270+		

Notes: * Order inlet with P+N+G configuration and receptacle with P+G configuration.

Notes: + Not UL/CSA listed.

 See pages 248-257 for detailed information on these options





Order Example: 480V DR50 + 2 auxiliary contacts





DR50 Poly inlet 3P+G = 31-38243-K04-972

INSTALLATION ACCESSORIES – SIZE 3

Unless indicated otherwise, accessories can be used with either poly or metal plugs and receptacles.





HANDLES

HANDLE w/NPT	Part # Poly	Part # Metal
 1/2"	513P0N05	593P0N05
 3/4"	513P0N07	593P0N07
 1"	513P0N10	593P0N10
 1 1/4"	513P0N12	593P0N12

HANDLE w/CORD GRIP Cable Range	Poly	Metal
 .625 - .750"	713P0CP4	793P0CS4
 .770 - .875"	713P0DP2	793P0DS1
 .875 - 1.000"	713P0DP3	793P0DS3
 1.000 - 1.125"	713P0EP2	793P0ES2

NYLON HANDLE w/Cable Range	Part # Poly	Part # Metal
 .39 - 1.18"	513P0D30	

Finger draw plates are recommended for easier connector closure on cord to cord assemblies.





POLY HANDLE W/CLAMP & BUSHING w/Cable Range	Part # Poly	Part # Metal
 .750 - .875"	713P0S14	
 .875 - 1.000"	713P0S16	
 1.000 - 1.125"	713P0S18	
 1.125 - 1.250"	713P0S20	
 1.250 - 1.375"	713P0S22	

POLY HANDLE W/BUILT IN DRAW GRIPS w/Cable Range	Part # Poly	Part # Metal
 .39 - 1.18"	513P0D30473	

Makes connector closures easier



For available cord grips, see pgs 178.
For a guideline of NPT based cable ranges, see DR30 on pg 99.

ANGLES

NYLON ANGLE	Angle	Part # Poly	Part # Metal
 30°	30°	513M3	
METAL ANGLE			
 0°	0°	593M0	
 30°	30°	593M3	
 FS/FD Box 30°	FS/FD Box 30°	793M3FS	
 70°	70°	593M7	

* Base measures approximately 4.2" x 2.7". Due to the variation in sizes of FS boxes, please verify that your FS box matches our dimensions, if not call Customer Service for other solutions.

BOXES

POLY CONDUIT ENTRY w/NPT	Angle	Size	Part # Poly	Part # Metal
 30° 3/4"	30°	3/4"	513B3N07	
 30° 1"	30°	1"	513B3N10	





* 13.5 in³

For poly devices only
* Interior volume with receptacle installed.

POLY WALL BOX w/NPT	Angle	Size	Part # Poly	Part # Metal
 70° 1/2" - 1 1/2"	70°	1/2" - 1 1/2"	513C7000	



* 179.41 in³





70° poly boxes are not drilled. Contact customer service if factory drilling is required.
* Interior volume with receptacle installed.

POLY ANGLE WITH ALUMINUM WALL BOX w/NPT	Angle	Size	Part # Poly	Part # Metal
 70° 1/2"	70°	1/2"	713C7N05	
 70° 3/4"	70°	3/4"	713C7N07	
 70° 1"	70°	1"	713C7N10	
 70° 1 1/4"	70°	1 1/4"	713C7N12	
 70° 1 1/2"	70°	1 1/2"	713C7N15	

* 170.0 in³

* Interior volume with receptacle installed.

METAL BOX w/NPT	Angle	Size	Part # Poly	Part # Metal
 0° 1/2"	0°	1/2"	7T1F0N05	
 0° 3/4"	0°	3/4"	7T1F0N07	
 0° 1"	0°	1"	7T1F0N10	
 0° 1 1/4"	0°	1 1/4"	7T1F0N12	

METAL BOX WITH NYLON ANGLE w/NPT	Angle	Size	Part # Poly	Part # Metal
 30° 1/2"	30°	1/2"	713C3N05	
 30° 3/4"	30°	3/4"	713C3N07	
 30° 1"	30°	1"	713C3N10	
 30° 1 1/4"	30°	1 1/4"	713C3N12	

* 29.6 in³

For metal angle, replace "71" prefix with "79".
* Interior volume with receptacle installed.

NPT on top or bottom (if rotated). For other NPT configurations, contact customer service.

MISCELLANEOUS ACCESSORIES

FINGER DRAWPLATES	Part # Poly	Part # Metal
	61-6A346	

Set of Two (2)
Recommended for cord to cord assembly applications, for easier connector closure.

PROTECTIVE CAP	Part # Poly	Part # Metal
	31-3A426	

For Male Devices Only.

PADLOCKABLE PLUG CAP	Part # Poly	Part # Metal
	DS3PC	

Poly
For Male Devices Only.

INLET SPRING-LOADED CAP	Part # Poly	Part # Metal
	31-3A226	

EASY RETROFIT ADAPTER PLATES	Part # Poly	Part # Metal
	see pg 175	

Mount to existing boxes.

RECEPTACLE LOCKING PIN	Part # Poly	Part # Metal
	LP-843	

Requires Padlockable Pawl option (-843) on receptacle.

DR100 Standard Duty Plugs & Receptacles – 100A

UL/CSA Ratings

- **Max Amperage & Voltage**
100A, 600 VAC
- **Current Interruption Capability**
For current interrupting up to 250 VAC
For Switch-Rated devices, see DS & DSN sections.
- **Short Circuit Rating**
100kA
Testing was performed with RK1 current limiting fuses sized at least 100% of the devices ampacity rating.
- **Environmental Ratings**
Type 3R (Standard)
Type 4X (Optional)
- **Temperature Range**
Min -40°F / Max 140°F
See pg 271 for temps below -15°F.
- **Wiring Capacity**
Min 10 AWG Max 2 AWG
Aux Contacts - Max 14 AWG
Based on THHN wire sizes
- **Certifications**
UL 1682, CSA 182.1

Receptacle (female)



Inlet (male)



! Don't forget to add installation accessories to your order

North American UL/CSA Configurations

Voltage	Polarity	Part #		Part #	
		Poly	Metal	Poly	Metal
120V	1P+N+G	31-64235-K16	39-64235-K16	31-68235-K16	39-68235-K16
120 208V	3P+N+G	31-64237-K16	39-64237-K16	31-68237-K16	39-68237-K16
125V	1P+N+G	31-64175-K07	39-64175-K07	31-68175-K07	39-68175-K07
125 250V	2P+N+G	31-64176-K07	39-64176-K07	31-68176-K07	39-68176-K07
208V	2P+G	31-64232-K16	39-64232-K16	31-68232-K16	39-68232-K16
208V	3P+G	31-64233-K16	39-64233-K16	31-68233-K16	39-68233-K16
250V	2P+G	31-64172-K07	39-64172-K07	31-68172-K07	39-68172-K07
250V	3P+G	31-64173-K07	39-64173-K07	31-68173-K07	39-68173-K07
277V	1P+N+G	31-64245-K04	39-64245-K04	31-68245-K04	39-68245-K04
277 480V	3P+N+G	31-64247-K04	39-64247-K04	31-68247-K04	39-68247-K04
347 600V	3P+N+G	31-64187-K14	39-64187-K14	31-68187-K14	39-68187-K14
480V	2P+G	31-64242-K04	39-64242-K04	31-68242-K04	39-68242-K04
480V	3P+G	31-64243-K04	39-64243-K04	31-68243-K04	39-68243-K04
600V	2P+G	31-64182-K14	39-64182-K14	31-68182-K14	39-68182-K14
600V	3P+G	31-64183-K14	39-64183-K14	31-68183-K14	39-68183-K14

For international configurations and ratings (IEC, CE) visit meltric.com/international-catalog or contact customer service at 800.433.7642.

Main Options



Auxiliary/Pilot Contacts



Mushroom Pawl



Padlock Pawl



Closed Lid Configuration

Recommended for cord applications to keep lid tucked in to avoid damage.

Receptacle Options

Suffix

Inlet Options

Suffix

With 2 Auxiliary/Pilot Contacts	Recept # - 972	With 2 Auxiliary/Pilot Contacts	Inlet # - 972
With 3 Auxiliary/Pilot Contacts	Recept # - 263	With 3 Auxiliary/Pilot Contacts	Inlet # - 263
With 4 Auxiliary/Pilot Contacts	Recept # - 264	With 4 Auxiliary/Pilot Contacts	Inlet # - 264
Type 4X & closed lid configuration	Recept # - 4X	Type 4X watertightness	Inlet # - 4X
Mushroom Pawl	Recept # - 375	With No Lockout Hole	Inlet # - A155
Padlock Pawl	Recept # - 843	For Auxiliary Switch*	Inlet # - NNF
Padlockable Mushroom Pawl	Recept # - 375-843		
Locking Mushroom Pawl	Recept # - 845		
Metal Pawl (on poly receptacle)	Recept # - 824		
180° Opening Lid (metal only)	Recept # - 180++		
Closed Lid Configuration	Recept # - NC		
With Auxiliary Switch	Recept # - 270+		

Notes: * Order inlet with P+N+G configuration and receptacle with P+G configuration.

Notes: + Not UL/CSA listed.
++ Required when mating to rigid mounted male inlet.



Order Example: 480V DR100 + 2 auxiliary contacts
DR100 Poly inlet 3P+G = 31-680243-K04-972

! See pages 248-257 for detailed information on these options

INSTALLATION ACCESSORIES – SIZE 4

Unless indicated otherwise, accessories can be used with either poly or metal plugs and receptacles.

HANDLES

HANDLE w/NPT	Part # Poly	Part # Metal
 1/2"	514P0N05	594P0N05
 3/4"	514P0N07	594P0N07
1"	514P0N10	594P0N10
1 1/4"	514P0N12	594P0N12
For metal devices only 1 1/2"	514P0N15	594P0N15

HANDLE w/CORD GRIP Cable Range	Poly	Metal
 1.000 - 1.125"	714P0EP2	-
1.270 - 1.470"	714P0EP3	-
1.250 - 1.375"	-	794P0ES4
1.438 - 1.562"	-	794P0FS2
For metal devices only 1.562 - 1.688"	-	794P0FS3

NYLON HANDLE w/Cable Range	Part #
 .51 - 1.38"	514P0D35

POLY HANDLE W/CLAMP & BUSHING w/Cable Range	Part #
 1.250 - 1.375"	714P0S22
1.438 - 1.562"	714P0S25
1.562 - 1.688"	714P0S27
1.688 - 1.812"	714P0S29

POLY HANDLE W/BUILT IN DRAW GRIPS w/Cable Range	Part #	Notes
 .51 - 1.38"	514P0D35473	Makes connector closures easier.







For available cord grips, see pg 178.

i

Cable Range	NPT	Cable Range	NPT
.312 - .625	1/2"	.875 - 1.375"	1 1/4"
.438 - .812	3/4"	.890 - 1.812"	1 1/2"
.660 - 1.000	1"		

NPT sizes are determined by the cable diameter and third party cord grip.

ANGLES

NYLON ANGLE	Part #	
 30°	514M3	
METAL ANGLE	Part #	
 0°	594M0	
 30°	594M3	
 30°	794M3L	
 Oversized 30°	794M3	Mounts on oversize box only. Order with 715FDNxx. See pg 48.
 70°	594M7	

BOXES

POLY CONDUIT ENTRY w/NPT	Part #	Notes
 30° 1/2"	514B3N05	For poly devices only
30° 3/4"	514B3N07	
30° 1"	514B3N10	* Interior volume with receptacle installed.
* 27.7 in ³ 30° 1 1/4"	514B3N12	

POLY WALL BOX w/NPT	Part #	Notes
 70° 1/2" - 2"	514C7000	70° poly boxes are not drilled. Contact customer service if factory drilling is required. * Interior volume with receptacle installed.
* 181.24 in ³		

POLY ANGLE WITH ALUMINUM WALL BOX w/NPT	Part #	Notes
 70° 1/2"	714C7N05	
70° 3/4"	714C7N07	
70° 1"	714C7N10	* Interior volume with receptacle installed.
70° 1 1/4"	714C7N12	
* 170.0 in ³ 70° 1 1/2"	714C7N15	

METAL BOX w/NPT	Part #
 0° 1"	7T4F0N10
0° 1 1/4"	7T4F0N12
0° 1 1/2"	7T4F0N15
0° 2"	7T4F0N20



METAL BOX WITH NYLON ANGLE w/NPT	Part #	Notes
 30° 1"	714C3N10	For metal angle, replace "71" prefix with "79".
30° 1 1/4"	714C3N12	
30° 1 1/2"	714C3N15	* Interior volume with receptacle installed.
* 61.0 in ³ Nylon Angle 30° 2"	714C3N20	* 59.4 in ³ Metal Angle

NPT on top or bottom (if rotated). For other NPT configurations, contact customer service.

MISCELLANEOUS ACCESSORIES

FINGER DRAWPLATES	Part #	Notes
 31-6A346	31-6A346	Set of Two (2) Recommended for cord to cord assembly applications, for easier connector closure.

PROTECTIVE CAP	Part #	Notes
 31-6A426	31-6A426	For Male Devices Only.

PADLOCKABLE PLUG CAP	Part #	Notes
 DS6PC	DS6PC	Poly – For Male Devices Only.
 DS6MC	DS6MC	Aluminum – For Male Devices Only.

INLET SPRING-LOADED CAP	Part #
 31-6A226	31-6A226

RECEPTACLE LOCKING PIN	Part #	Notes
 LP-843	LP-843	Requires Padlockable Pawl option (-843) on receptacle.

DR150 Standard Duty Plugs & Receptacles – 150A

UL/CSA Ratings

- **Max Amperage & Voltage**
150A, 600 VAC
- **Current Interruption Capability**
For current interrupting up to 250 VAC
 For Switch-Rated devices, see DS & DSN sections.
- **Short Circuit Rating**
65kA
Testing was performed with RK1 current limiting fuses sized at least 100% of the devices ampacity rating.
- **Environmental Ratings**
Type 4X (Poly Standard)
Type 3R (Metal Standard)
Type 4X (Metal Optional)
- **Temperature Range**
Min -40°F / Max 140°F
See pg 271 for temps below -15°F.
- **Wiring Capacity**
Min 4 AWG Max 2/0 AWG
Aux Contacts - Max 14 AWG
Based on THHN wire sizes
- **Certifications**
UL 1682, CSA 182.1

Receptacle (female)

Inlet (male)



H If you have an existing removable and/or permanently attached drawbar, contact customer service.

! Don't forget to add installation accessories to your order

North American UL/CSA Configurations

Voltage	Polarity	Part #		Part #	
		Poly	Metal	Poly	Metal
120V	1P+N+G	31-94235-K16	39-94235-K16	31-98235-K16	39-98235-K16
120 208V	3P+N+G	31-94237-K16	39-94237-K16	31-98237-K16	39-98237-K16
125V	1P+N+G	31-94175-K07	39-94175-K07	31-98175-K07	39-98175-K07
125 250V	2P+N+G	31-94176-K07	39-94176-K07	31-98176-K07	39-98176-K07
208V	2P+G	31-94232-K16	39-94232-K16	31-98232-K16	39-98232-K16
208V	3P+G	31-94233-K16	39-94233-K16	31-98233-K16	39-98233-K16
250V	2P+G	31-94172-K07	39-94172-K07	31-98172-K07	39-98172-K07
250V	3P+G	31-94173-K07	39-94173-K07	31-98173-K07	39-98173-K07
277V	1P+N+G	31-94245-K04	39-94245-K04	31-98245-K04	39-98245-K04
277 480V	3P+N+G	31-94247-K04	39-94247-K04	31-98247-K04	39-98247-K04
347 600V	3P+N+G	31-94187-K14	39-94187-K14	31-98187-K14	39-98187-K14
480V	2P+G	31-94242-K04	39-94242-K04	31-98242-K04	39-98242-K04
480V	3P+G	31-94243-K04	39-94243-K04	31-98243-K04	39-98243-K04
600V	2P+G	31-94182-K14	39-94182-K14	31-98182-K14	39-98182-K14
600V	3P+G	31-94183-K14	39-94183-K14	31-98183-K14	39-98183-K14

For international configurations and ratings (IEC, CE) visit meltric.com/international-catalog or contact customer service at 800.433.7642.

Main Options

- Auxiliary/Pilot Contacts
- Mushroom Pawl
- Padlock Pawl
- Closed Lid Configuration
Recommended for cord applications to keep lid tucked in to avoid damage.

Receptacle Options

Suffix

Inlet Options

Suffix

With 2 Auxiliary/Pilot Contacts	Recept # - 262	With 2 Auxiliary/Pilot Contacts	Inlet # - 262
With 3 Auxiliary/Pilot Contacts	Recept # - 263	With 3 Auxiliary/Pilot Contacts	Inlet # - 263
With 4 Auxiliary/Pilot Contacts	Recept # - 264	With 4 Auxiliary/Pilot Contacts	Inlet # - 264
With 5 Auxiliary/Pilot Contacts	Recept # - 975	With 5 Auxiliary/Pilot Contacts	Inlet # - 975
With 6 Auxiliary/Pilot Contacts	Recept # - 976	With 6 Auxiliary/Pilot Contacts	Inlet # - 976
Type 4X & closed lid configuration	Recept # - 4X [†]	Type 4X watertightness	Inlet # - 4X [†]
Mushroom Pawl	Recept # - 375	With No Lockout Hole	Inlet # - A155
Padlock Pawl	Recept # - 843	For Auxiliary Switch*	Inlet # - NNF
Padlockable Mushroom Pawl	Recept # - 375-843		
Locking Mushroom Pawl	Recept # - 845		
Metal Pawl (on poly receptacle)	Recept # - 824		
180° Opening Lid	Recept # - 180++ [‡]		
Closed Lid Configuration	Recept # - NC		
With Auxiliary Switch	Recept # - 270+		

Notes: * Order inlet with P+N+G configuration and receptacle with P+G configuration.

! See pages 248-257 for detailed information on these options





Notes: + Not UL/CSA listed.
++ Required when mating to rigid mounted male inlet.
† Metal devices only.





Order Example: 480V DR150 + 2 auxiliary contacts
DR150 Poly inlet 3P+G = 31-982043-K04-972







INSTALLATION ACCESSORIES – SIZE 5



Unless indicated otherwise, accessories can be used with either poly or metal plugs and receptacles.





HANDLES

HANDLE w/NPT	Part # Poly	Part # Metal
 3/4"	515P0N07	595P0N07
 1"	515P0N10	595P0N10
 1 1/4"	515P0N12	595P0N12
 1 1/2"	515P0N15	595P0N15
For metal devices only 2"	515P0N20	595P0N20





HANDLE w/CORD GRIP	Cable Range	Poly	Metal
	1.270 - 1.470"	715P0EP3	-
	1.250 - 1.375"	-	795P0ES4
	1.438 - 1.562"	-	795P0FS2
	1.562 - 1.688"	-	795P0FS3
For metal devices only 1.520 - 1.860"	1.520 - 1.860"	715P0GP2	-

OVERSIZED METAL HANDLE w/NPT	Part # Poly	Part # Metal
 3/4"	795P0N07	-
 1"	795P0N10	-
 1 1/4"	795P0N12	For available cord grips, see pg 178.
 1 1/2"	795P0N15	For metal devices only.
 2"	795P0N20	-
 2 1/2"	795P0N25	-



SANTOPRENE HANDLE w/Cable Range	Cable Range	Part # Poly	Part # Metal
	.70 - 1.00"	555P0D25	-
	1.00 - 1.375"	555P0D35	-
IP66/IP67 1.375 - 1.771"	1.375 - 1.771"	555P0D45	-

POLY HANDLE W/CLAMP & BUSHING w/Cable Range	Cable Range	Part # Poly	Part # Metal
	1.250 - 1.375"	715P0S22	-
	1.438 - 1.562"	715P0S25	-
	1.562 - 1.688"	715P0S27	-
	1.688 - 1.812"	715P0S29	-



ANGLES

NYLON ANGLE	Angle	Part # Poly	Part # Metal
 30°	30°	515M3	-
METAL ANGLE			
 0°	0°	595M0	-
 30°	30°	595M3	-
 Oversized 30°	Oversized 30°	795M3	Mounts on oversize metal box only. Order with 7T6F0N25XL. See pg 107.
 70°	70°	595M7	-

BOXES

NYLON ANGLE WITH METAL BOX w/NPT	Angle	Box Size	Part # Poly	Part # Metal
 30°	30°	1 1/4"	715C3N12	-
 30°	30°	1 1/2"	715C3N15	-
 30°	30°	2"	715C3N20	-
* 108.7 in ³ 30°	30°	2 1/2"	715C3N25	-

* Interior volume with receptacle installed.

METAL ANGLE WITH METAL BOX w/NPT	Angle	Box Size	Part # Poly	Part # Metal
 30°	30°	1 1/4"	795C3N12	-
 30°	30°	1 1/2"	795C3N15	-
 30°	30°	2"	795C3N20	-
* 111.8 in ³ 30°	30°	2 1/2"	795C3N25	-

* Interior volume with receptacle installed.

METAL BOX w/NPT	Angle	Box Size	Part # Poly	Part # Metal
 0°	0°	1 1/4"	7T5F0N12	-
 0°	0°	1 1/2"	7T5F0N15	-
 0°	0°	2"	7T5F0N20	-
 0°	0°	2 1/2"	7T5F0N25	-

NPT on top or bottom (if rotated). For other NPT configurations, contact customer service.

i

Cable Range	NPT	Cable Range	NPT
.438 - .812	3/4"	.890 - 1.812"	1 1/2"
.660 - 1.000	1"	1.190 - 2.438"	2"
.875 - 1.375"	1 1/4"		

NPT sizes are determined by the cable diameter and third party cord grip.

MISCELLANEOUS ACCESSORIES

PROTECTIVE CAP	Part # Poly	Part # Metal
	35-9A126	For watertight seal, the male inlet must also be ordered with the 'No Lockout Hole' option (-A155). For Male Devices Only.

PADLOCKABLE PLUG CAP	Part # Poly	Part # Metal
	DS9MC	Aluminum - For Male Devices Only.

CORD GRIP with MESH	Part # Poly	Part # Metal
	see pg 178	-

EASY RETROFIT ADAPTER PLATES	Part # Poly	Part # Metal
	see pg 175	Mount to existing boxes.

RECEPTACLE LOCKING PIN	Part # Poly	Part # Metal
	LP-843	Requires Padlockable Pawl option (-843) on receptacle.

DR250 Standard Duty Plugs & Receptacles – 250A

UL/CSA Ratings

- **Max Amperage & Voltage**
250A, 600 VAC
- **Current Interruption Capability**
Not for current interrupting
For Switch-Rated devices, see DS & DSN sections.
- **Short Circuit Rating**
10kA
Testing was performed with RK1 current limiting fuses sized at least 100% of the devices ampacity rating.
- **Environmental Ratings**
Type 3R (Standard)
Type 4X (Optional)
- **Temperature Range**
Min -40°F / Max 140°F
See pg 271 for temps below -15°F.
- **Wiring Capacity**
Min 4 AWG Max 4/0 AWG
Aux Contacts - Max 14 AWG
Based on THHN wire sizes
- **Certifications**
UL 1682, CSA 182.1

Receptacle (female)

Easy Closing Mechanism



Standard DR250 lid opens to 90°

Inlet (male)



Tabs for latching to closing mechanism

H If you have an existing removable and/or permanently attached drawbar, contact customer service.

! Don't forget to add installation accessories to your order

North American UL/CSA Configurations

Voltage	Polarity	Part # Metal	Part # Metal
120V	1P+N+G	39-24235-K16	39-28235-K16
120 208V	3P+N+G	39-24237-K16	39-28237-K16
125V	1P+N+G	39-24035-K07	39-28035-K07
125 250V	2P+N+G	39-24036-K07	39-28036-K07
208V	2P+G	39-24232-K16	39-28232-K16
208V	3P+G	39-24233-K16	39-28233-K16
250V	2P+G	39-24032-K07	39-28032-K07
250V	3P+G	39-24033-K07	39-28033-K07
277V	1P+N+G	39-24245-K04	39-28245-K04
277 480V	3P+N+G	39-24247-K04	39-28247-K04
347 600V	3P+N+G	39-24027-K14	39-28027-K14
480V	2P+G	39-24242-K04	39-28242-K04
480V	3P+G	39-24243-K04	39-28243-K04
600V	2P+G	39-24022-K14	39-28022-K14
600V	3P+G	39-24023-K14	39-28023-K14

For international configurations and ratings (IEC, CE) visit meltric.com/international-catalog or contact customer service at 800.433.7642.

Main Options



Auxiliary/Pilot Contacts



Mushroom Pawl



Padlock Pawl



Closed Lid Configuration
Recommended for cord applications to keep lid tucked in to avoid damage.

Receptacle Options

Suffix

Inlet Options

Suffix

With 2 Auxiliary/Pilot Contacts	Recept # - 972*	With 2 Auxiliary/Pilot Contacts	Inlet # - 972*
With 4 Auxiliary/Pilot Contacts	Recept # - 174+	With 4 Auxiliary/Pilot Contacts	Inlet # - 174+
With 6 Auxiliary/Pilot Contacts	Recept # - 976+	With 6 Auxiliary/Pilot Contacts	Inlet # - 976+
Type 4X & closed lid configuration	Recept # - 4X	Type 4X watertightness	Inlet # - 4X
Mushroom Pawl	Recept # - 375	For Auxiliary Switch*	Inlet # - NNF
Padlock Pawl	Recept # - 843	With No Lockout Hole	Inlet # - A155
Padlockable Mushroom Pawl	Recept # - 375-843		
Locking Mushroom Pawl	Recept # - 845		
180° Opening Lid	Recept # - 180++		
Closed Lid Configuration	Recept # - NC		
With Auxiliary Switch	Recept # - 270+++		

Notes: * Order inlet with P+N+G configuration and receptacle with P+G configuration.

- Notes:**
- * Customers needing to maintain compatibility with old style -172 auxiliary contacts should use a -172 suffix.
 - + This option not available with N contact.
 - ++ Required when mating to rigid mounted male inlet.
 - +++ Not UL/CSA listed.

Order Example: 480V DR250 + 2 auxiliary contacts
DR250 Metal inlet 3P+G = 39-28243-K04-972

! See pages 248-257 for detailed information on these options

INSTALLATION ACCESSORIES – SIZE 6

Unless indicated otherwise, accessories can be used with either poly or metal plugs and receptacles.

HANDLES

HANDLE w/NPT	Part # Poly	Part # Metal
 1"	-	596P0N10
1 1/4"	-	596P0N12
1 1/2"	516P0N15	596P0N15
2"	516P0N20	596P0N20
2 1/2"	516P0N25	596P0N25
For metal devices only 3"	-	596P0N30



HANDLE w/CORD GRIP	Cable Range	Poly	Metal
	1.688 - 1.812"	-	796P0GS1
	1.812 - 1.938"	-	796P0GS2
	1.850 - 2.190"	716P0GP3	-
	1.938 - 2.062"	-	796P0GS3
	2.062 - 2.188"	-	796P0GS4
	2.188 - 2.312"	-	796P0GS5
	2.312 - 2.438"	-	796P0GS6
	2.437 - 2.625"	-	796P0KS1
	2.625 - 2.812"	-	796P0KS2

OVERSIZED METAL HANDLE w/NPT	Part # Poly	Part # Metal
 1 1/4"	597P0N12	
1 1/2"	597P0N15	
2"	597P0N20	For Metal Devices Only.
2 1/2"	597P0N25	
3"	597P0N30	

SANTOPRENE HANDLE w/Cable Range	Part # Poly	Part # Metal
 1.000 - 1.375"	556P0D35	
1.375 - 1.750"	556P0D45	
IP66/IP67 1.750 - 1.900"	556P0D49	

For available cord grips, see pg 178.

ANGLES

METAL ANGLE	Part # Poly	Part # Metal
 0°	596M0	
 Oversized 45°	796M4	Mounts on oversize metal box only. Order with 7T6F0N25XL.
 60°	596M6	
 Extended 60°	597M6	

BOXES

BOX ANGLE WITH METAL BOX w/NPT	Part # Poly	Part # Metal
 60° 1 1/2"	796C6N15	
60° 2"	796C6N20	
* 248.4 in ³ 60° 2 1/2"	796C6N25	

* Interior volume with receptacle installed.

METAL BOX w/NPT	Part # Poly	Part # Metal
 0° 1 1/2"	7T6F0N15	
0° 2"	7T6F0N20	
0° 2 1/2"	7T6F0N25	

* Interior volume with receptacle installed.

OVERSIZED METAL BOX w/NPT	Part # Poly	Part # Metal
 0° 2 1/2"	7T6F0N25XL	

NPT on top or bottom (if rotated). For other NPT configurations, contact customer service.

Cable Range	NPT	Cable Range	NPT
.660 - 1.000"	1"	1.190 - 2.438"	2"
.875 - 1.375"	1 1/4"	2.062 - 2.438"	2 1/2"
.890 - 1.812"	1 1/2"	2.438 - 2.812"	3"

NPT sizes are determined by the cable diameter and third party cord grip.

MISCELLANEOUS ACCESSORIES

PROTECTIVE CAP	Part # Poly	Part # Metal
	35-2A126	For watertight seal, the male inlet must also be ordered with the 'No Lockout Hole' option (-A155). For Male Devices Only.

PADLOCKABLE PLUG CAP	Part # Poly	Part # Metal
	DS2MC	Aluminum – For Male Devices Only.

CORD GRIP with MESH	Part # Poly	Part # Metal
	see pg 178	

RECEPTACLE LOCKING PIN	Part # Poly	Part # Metal
	LP-843	Requires Padlockable Pawl option (-843) on receptacle.

DR400 Standard Duty Plugs & Receptacles – 400A

UL/CSA Ratings

- Max Amperage & Voltage**
 400A Max to 480 VAC
 350A Max to 600 VAC
- Current Interruption Capability**
 Not for current interrupting
- Short Circuit Rating**
 18kA
 A withstand test was performed with RK1 current limiting fuses sized at at least 100% of the devices ampacity rating.
- Environmental Ratings**
 IP54/IP55*
 *IP54 when the plug & receptacle are mated. IP55 on the receptacle alone when the lid is latched closed.
- Temperature Range**
 Min -40°F / Max 140°F
- Wiring Capacity**
 Min 2 AWG Max 350 MCM*
 Aux Contacts – 14 AWG (prewired)
 * Wire size to 500 MCM can be accommodated through use of Cable Reducing Adapters. See Accessory Spotlight.
- Certifications**
 UL 1682
 CSA 182.1

Receptacle (female)



Inlet (male)

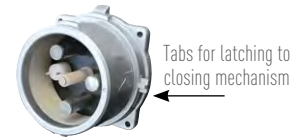

! Don't forget to add installation accessories to your order

North American UL/CSA Configurations

Voltage	Polarity	Part # Metal	Part # Metal
208V	3P+G+2PIL	39-44163-172	39-48163-172
250V	3P+G+2PIL	39-44073-172	39-48073-172
480V	3P+G+2PIL	39-44043-172	39-48043-172
600V	3P+G+2PIL	39-44143-172	39-48143-172

* 350A only for 600V models
 Other voltage configurations are available - contact customer service at 800.433.7642

For international configurations and ratings (IEC,CE) visit meltric.com/international-catalog or contact customer service at 800.433.7642.

Key Feature

Standard Locking Pawl



DR400 receptacles are provided with a screw-type locking pawl that prevents accidental disconnections under load.

Receptacle Options	Suffix #	Inlet Options	Suffix #
IP66/IP67	Recept # - 4X	IP66/IP67	Inlet # - 4X
Closed Lid Configuration	Recept # - NC	With No Lockout Hole	Inlet # - A155

Order Example: DR400 with Cable Reducing Adapters

To accommodate 500 MCM cable, cable reducing adapters and an extended angle with spacer accessory is required.

Typical order: 480V 3P+G+2PIL



! See pages 248-257 for detailed information on these options

INSTALLATION ACCESSORIES – SIZE 7

Unless indicated otherwise, accessories can be used with either poly or metal plugs and receptacles.

HANDLES

LARGE HANDLE w/NPT	Part #
2"	5T7P0N20
2 1/2"	5T7P0N25
3"	5T7P0N30

LARGE HANDLE w/CORD GRIP Cable Range	Part #
2.062 - 2.188"	5T7P0JT1
2.188 - 2.312"	5T7P0JT2
2.312 - 2.438"	5T7P0JT3
2.437 - 2.625"	5T7P0KT1
2.625 - 2.812"	5T7P0KT2

STRAIGHT HANDLE W/BUSHING w/Cable Range	Part #
2.09 - 2.25"	5T7P0D57
2.25 - 2.44"	5T7P0D62
2.44 - 2.67"	5T7P0D68
2.67 - 2.87"	5T7P0D73

ANGLES

METAL ANGLE	Part #	Description
0°	5T7M0	
Extended 60°	5T7M6	
Extended 60° with 68 mm spacer.	5T7M6-68	Provides space for Cable Reducing Adapters.

BOXES

BOX ANGLE WITH METAL BOX w/NPT	Part #
0° 2"	7T7F0N20
0° 2 1/2"	7T7F0N25
0° 3"	7T7F0N30
0° 3 1/2"	7T7F0N35
0° 4"	7T7F0N40

MISCELLANEOUS ACCESSORIES

PROTECTIVE CAP	Part #	Description
	35-2A126	For Male Devices Only.
CABLE REDUCING ADAPTERS		
	PT535FX350-3	Reducer for 500 MCM Fine Stranded or Flexible Wire.
	PT500R350-3	Reducer for 500 MCM Coarse Stranded or Building Wire.
	PT400R350-3	Reducer for 400 MCM Wire.
SPACER		
	5T7M0-68	68mm [2.68"] spacer is used [included] with metal 60° angle.
	5T7M0-115	115mm can be used when mounting to a panel - though the metal straight adapter is preferred.
PADLOCKABLE PLUG CAP		
	DS2MC	Aluminum - For Male Devices Only.
RECEPTACLE LOCKING PIN		
	LP-843	Requires Padlockable Pawl option (-843) on receptacle.

DR / PN

DIMENSIONS – Provided in inches

Dimensions are for reference only and may change depending on accessories used. For precise dimensions contact MELTRIC Engineering.

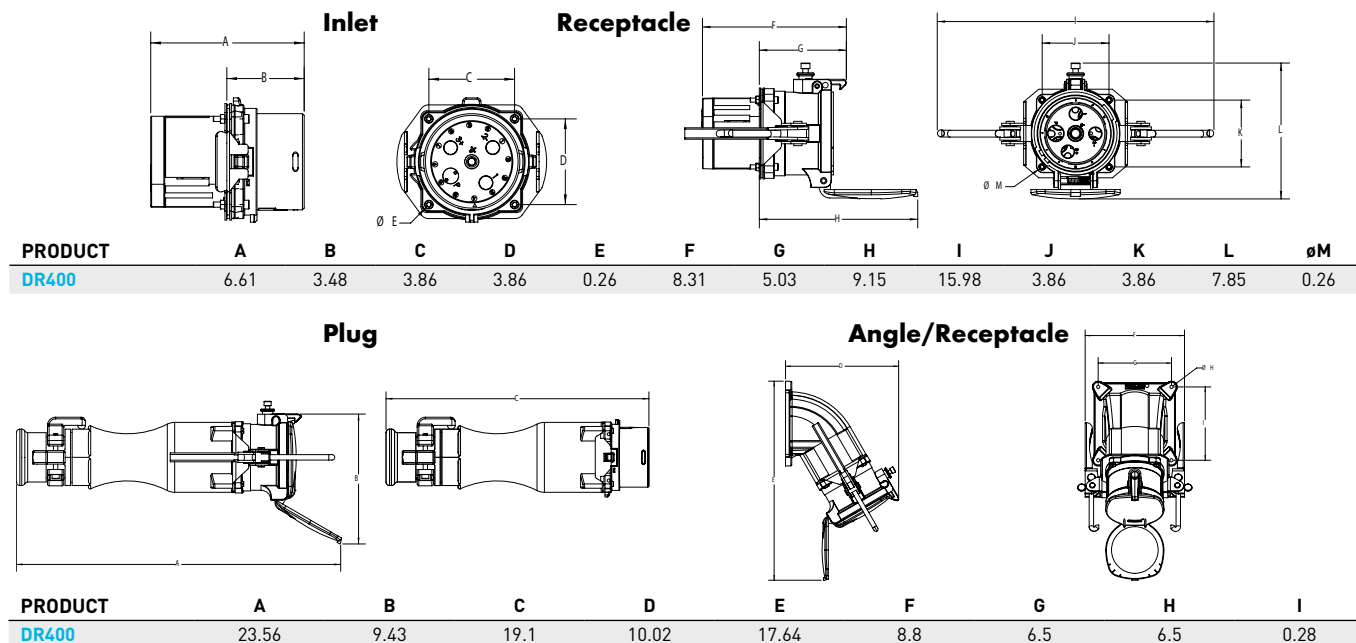

DR SPARE PARTS Male Configuration

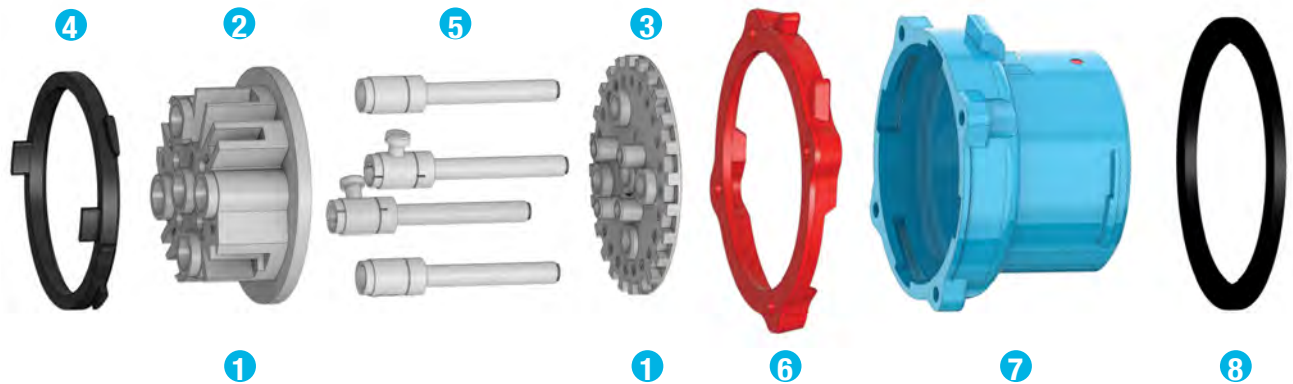

	DR30 POLY	DR50 POLY	DR100 POLY	DR100 METAL	DR150 POLY	DR150 METAL	DR250 METAL	DR400 METAL	
1 Plug Interior***	31-1A010*	31-3A010*	31-6A010*	31-6A010*	61-9A010*	69-9A010*	39-2A010-A06*	-	
1 Plug Interior w/Ground Contacts***	-	-	-	39-6A110*	-	69-9A110*	39-2A110-A06*	-	
1 Plug Interior with 2 Pilots+	31-1A310-972*	31-3A310-972*	31-6A310-972*	31-6A310-972*	61-9A310-262*	61-9A310-262*	39-2A310-172-A06*	39-4A310-172*	
2 Interior Bottom***	31-1A010-B	31-3A010-B	31-6A010-B	31-6A010-B	61-9A551	69-9A551	39-2A010-B-A06	39-4A010-B	
3 Interior Top***	31-1A010-T*	31-3A010-T*	31-6A010-T*	31-6A010-T*	61-9A010-T*	69-9A010-T*	39-2A010-T*	39-4A010-T*	
4 Polyester Locking Ring	31-1A583	31-3A583	31-6A583	-	31-9A583	-	-	-	
4 Metal Locking Ring	-	-	-	39-6A583	-	39-9A583	39-2A583	39-4A583	
5 Plug Phase Contact (If no aux. contacts)	31-1A011-380	31-3A011-380	31-6A011	31-6A011	61-9A011	61-9A011	39-2A011-A06	-	
5 Plug Phase Contact (If plug has aux. contacts)	31-1A011	31-3A011-380	31-6A011	31-6A011	61-9A011	61-9A011	39-2A011-A06	39-4A011	
5 Plug Ground Contact	31-1A019	31-3A019	31-6A019	39-6A019	61-9A019	69-9A019	39-2A019-A06	39-4A019	
6 Color-Coded Voltage Gasket	125V	31-1AC26	31-3AC26	31-6AC26	31-6AC26	31-9AC26	31-9AC26	39-2AC26	-
	208V	31-1AB26	31-3AB26	31-6AB26	31-6AB26	31-9AB26	31-9AB26	39-2AB26	-
	250V	31-1AC26	31-3AC26	31-6AC26	31-6AC26	31-9AC26	31-9AC26	39-2AC26	-
	480V	31-1AR26	31-3AR26	31-6AR26	31-6AR26	31-9AR26	31-9AR26	39-2AR26	-
	600V	31-1AN26	31-3AN26	31-6AN26	31-6AN26	31-9AN26	31-9AN26	39-2AN26	-
7 Plug Polyester Casing w/Plug Gasket	31-1A014**	31-3A014**	31-6A014**	-	61-9A014**	-	-	-	
7 Plug Metal Casing w/Plug Gasket	-	-	-	39-6A014**	-	39-9A014**	39-2A014**	39-4A014**	
8 Type 4X Gasket	31-1A056	31-3A056	31-6A066	39-6A066	-	31-9A066	39-2A056	-	

* Voltage and phasing positions must be specified (5th, 6th & 7th digit of Part #) to duplicate your shutter and alignment notches.

** For appropriate labeling on a device, please specify voltage, phasing, and product type.

*** For interiors with pilot contacts, contact Customer Service for part numbers.

+ For interiors with more than 2 pilot contacts, contact Customer Service for part numbers.

DR SPARE PARTS Female Configuration

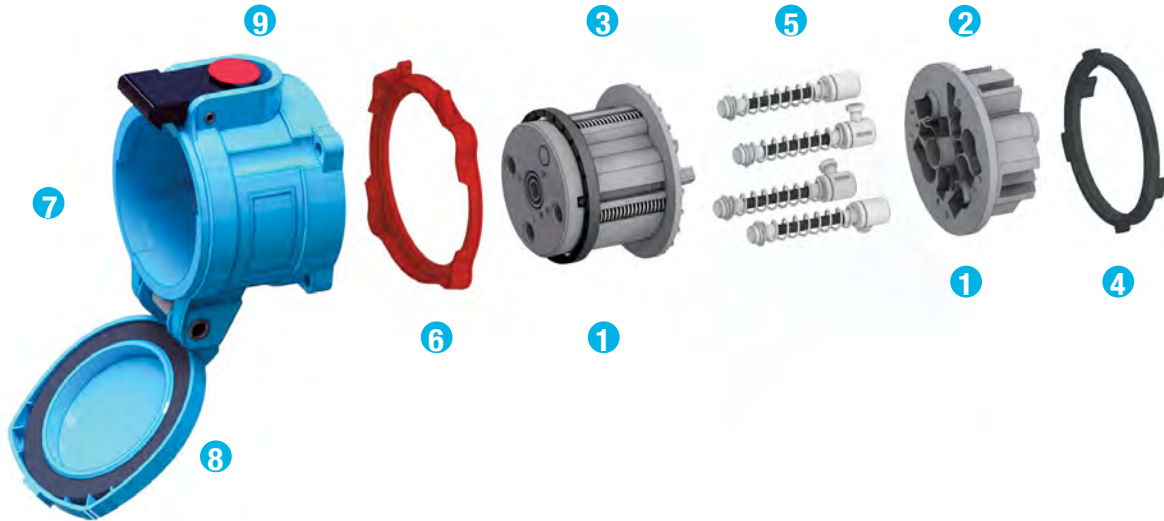

	DR30 POLY	DR50 POLY	DR100 POLY	DR100 METAL	DR150 POLY	DR150 METAL	DR250 METAL	DR400 METAL
1 Receptacle Interior***	31-1A020*	31-3A020*	31-6A020*	31-6A020*	61-9A020*	69-9A020*	39-2A020-A06*	
1 Recept Interior w/Ground Contacts***	-	-	-	39-6A220*	-	69-9A220*	39-2A220-A06*	
1 Receptacle Interior with 2 Pilots+	31-1A320-972*	31-3A320-972*	31-6A320-972*	31-6A320-972*	61-9A320-262*	61-9A320-262*	39-2A320-172-A06*	39-4A320-172*
2 Interior Bottom***	31-1A020-B	31-3A020-B	31-6A020-B	31-6A020-B	61-9A552	69-9A552	39-2A020-B-A06	39-4A020-B
3 Interior Top***	31-1A020-T*	31-3A020-T*	31-6A020-T*	31-6A020-T*	61-9A020-T*	69-9A020-T*	39-2A020-T*	39-4A020-T*
4 Polyester Locking Ring	31-1A583	31-3A583	31-6A583	-	31-9A583	-	-	
4 Metal Locking Ring	-	-	-	39-6A583	-	39-9A583	39-2A583	39-4A583
5 Recept Phase Contact (If no aux. contacts)	31-1A021-380	31-3A021-380	31-6A021	31-6A021	61-9A021	61-9A021	39-2A021-A06	
5 Recept Phase Contact (If plug has aux. contacts)	31-1A021	31-3A021-380	31-6A021	31-6A021	61-9A021	61-9A021	39-2A021-A06	39-4A021
5 Recept Ground Contact	31-1A029	31-3A029	31-6A029	39-6A029	61-9A029	69-9A029	39-2A029-A06	39-4A029
6 Color-Coded Voltage Gasket	125V	31-1AC26	31-3AC26	31-6AC26	31-6AC26	31-9AC26	31-9AC26	39-2AC26
	208V	31-1AB26	31-3AB26	31-6AB26	31-6AB26	31-9AB26	31-9AB26	39-2AB26
	250V	31-1AC26	31-3AC26	31-6AC26	31-6AC26	31-9AC26	31-9AC26	39-2AC26
	480V	31-1AR26	31-3AR26	31-6AR26	31-6AR26	31-9AR26	31-9AR26	39-2AR26
	600V	31-1AN26	31-3AN26	31-6AN26	31-6AN26	31-9AN26	31-9AN26	39-2AN26
7 Receptacle Polyester Casing w/Lid	31-1A024**	31-3A024**	31-6A024**	-	61-9A024**	-	-	
7 Receptacle Metal Casing with Lid	-	-	-	39-6A024**	-	39-9A024**	39-2A024**	39-4A024** ++
8 Lid Replacement Kit Polyester	31-1A125	31-3A125	31-6A425	-	61-9A125	-	-	
8 Lid Replacement Kit Metal	-	-	-	39-6A925	-	39-9A925	39-2A925	
9 Pawl Replacement Kit Polyester	31-1A824	31-3A824	31-6A824	-	61-9A824	-	-	
9 Pawl Replacement Kit Metal	39-1A824	39-3A824	39-6A824	39-6A824	69-9A924	39-9A824	39-2A824	

* Voltage and phasing positions must be specified (5th, 6th & 7th digit of Part #) to duplicate your shutter and alignment notches.

** For appropriate labeling on a device, please specify voltage, phasing, and product type.

*** For interiors with 2 pilot contacts, contact Customer Service for part numbers.

+ For interiors with more than 2 pilot contacts, contact Customer Service for part numbers.

++ For DR 400 Drawbar Accessory contact Customer Service.

For replacement parts contact customer service at 800.433.7642

DR DIMENSIONS – Provided in inches

Dimensions are for reference only and may change depending on accessories used. For precise dimensions contact MELTRIC Engineering.

Plug

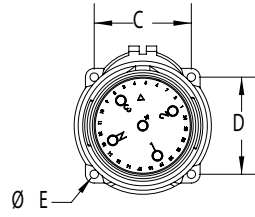
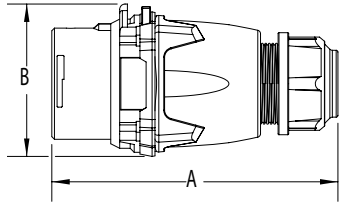

Inlet

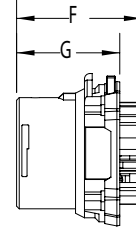

PRODUCT	A	B	C	D	øE	F	G
DR30	5.72	2.79	1.89	1.89	0.2	2.28	1.86
DR50	6.15	3.23	2.17	2.17	0.2	2.93	2.07
DR100/DR7c	6.7	3.77	2.59	2.59	0.24	3.42	2.38
DR150	8.33	4.59	3.2	3.2	0.24	4.14	3.04
DR250	10.3	5.67	3.86	3.86	0.26	4.66	3.2

Connector

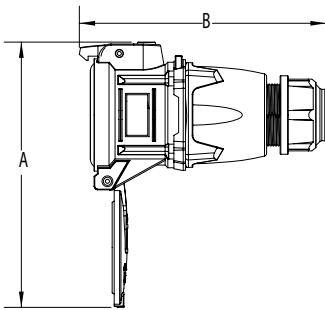

Receptacle

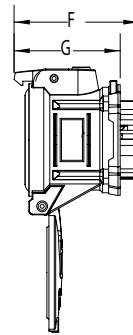
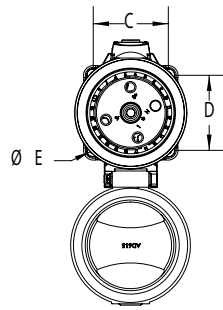

Extended Draw bars

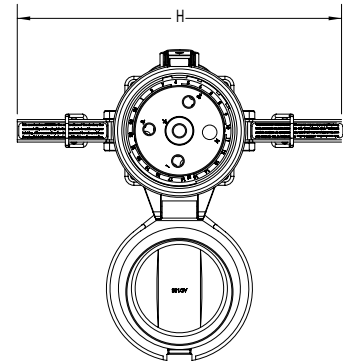

PRODUCT	A	B	C	D	øE	F	G	H
DR30	6.32	6.38	1.89	1.89	0.2	3.3	2.6	N/A
DR50	7.16	6.93	2.17	2.17	0.2	3.73	2.87	N/A
DR100/DR7c	8.46	7.75	2.59	2.59	0.22	4.53	3.37	N/A
DR150	11.04	10.02	3.2	3.2	0.23	5.71	4.74	11.52
DR250	11.54	10.87	3.86	3.86	0.26	6.21	4.75	12.07

Box/30° Angle/ Receptacle/Plug

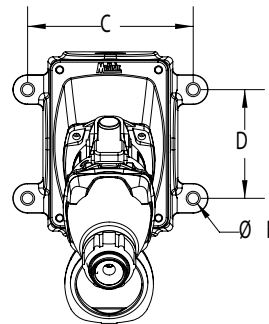
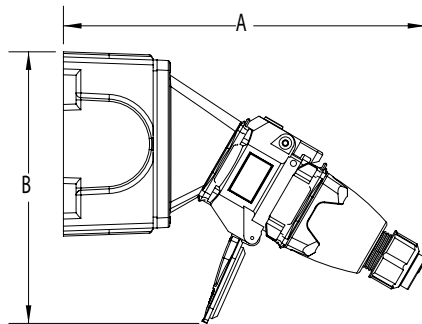

PRODUCT	A	B	C	D	øE
DR30	9.84	7.29	4.19	2.75	0.27
DR50	10.3	8.39	4.19	2.75	0.27
DR100/DR7c	11.87	10.45	5	3.81	0.33
DR150	16.06	11.77	6.75	4.25	0.31
DR250	15.76	11.54	8.13	6.38	0.31



30° Angle/Receptacle/Plug

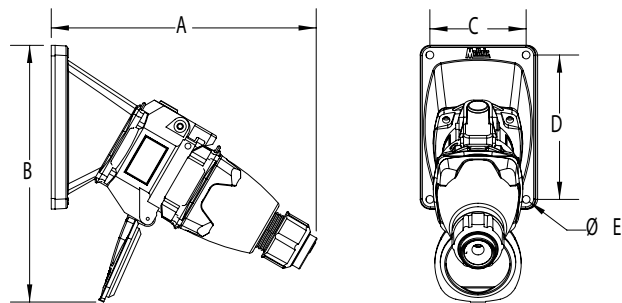

PRODUCT	A	B	C	D	ØE
DR30	7.60	7.87	2.50	3.75	0.22
DR50	8.19	8.44	2.50	3.75	0.22
DR100/DR7c	9.17	10.16	3.43	4.83	0.26
DR150	14.09	12.05	4.83	4.83	0.28
DR250	11.61	15.03	6.50	6.50	0.25

70° Wall Box/ Receptacle

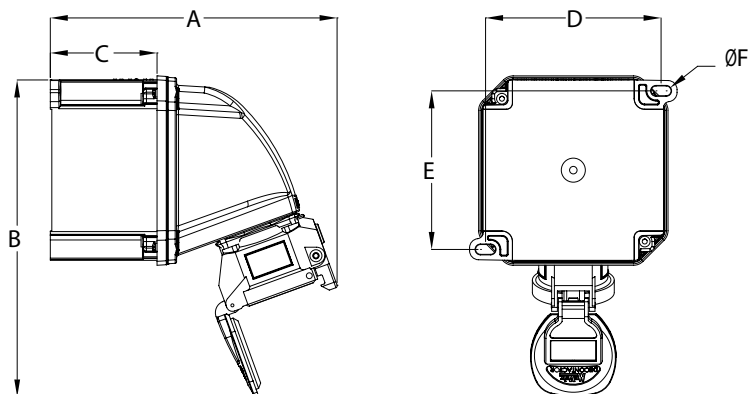

PRODUCT	A	B	C	D	E	ØF
DR30	7.51	8.30	2.80	4.60	4.15	0.26
DR50	7.93	9.51	2.80	4.60	4.15	0.26
DR100/DR7c*	8.91	11.55	2.80	6.17	5.73	0.26

* Box has 4 mounting feet

Plug/Connector

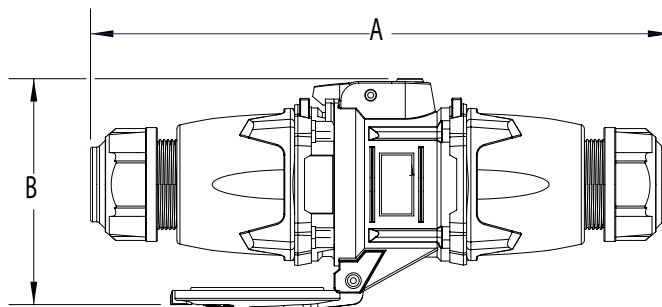

PRODUCT	A	B
DR30	10.2	4.61
DR50	10.91	5.71
DR100/DR7c	12.17	6.57
DR150	19.53	8.03
DR250	23.15	8



PN Standard Duty plug and receptacle

Main Advantages

- ▶ Compact yet durable device
- ▶ Spring-loaded silver-nickel devices
- ▶ Spring-assisted terminals are unaffected by vibrations and thermal cycling

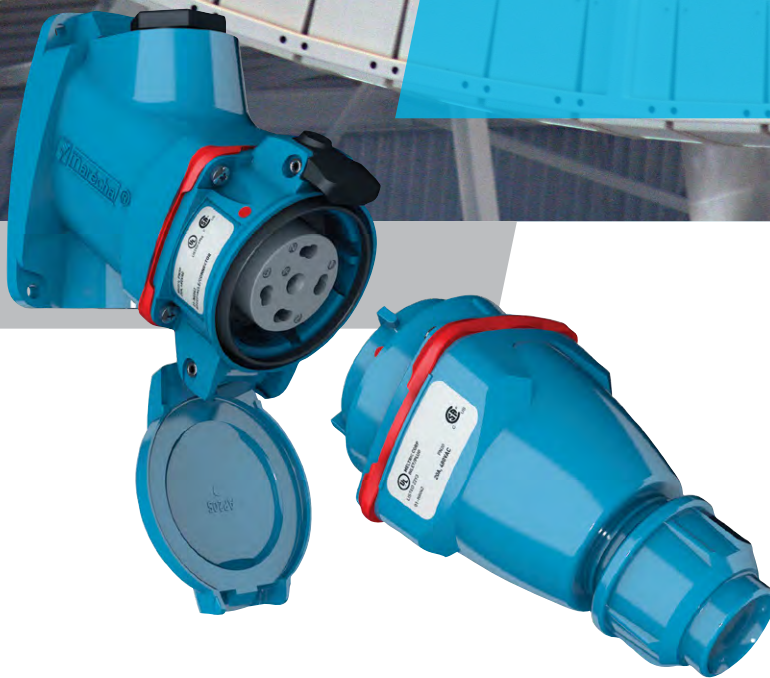

- ▶ **Features and Ratings** p. 115
- ▶ **PN20** p. 116
- ▶ **Spare parts** p. 118
- ▶ **Dimensions** p. 120

PRODUCT FEATURES

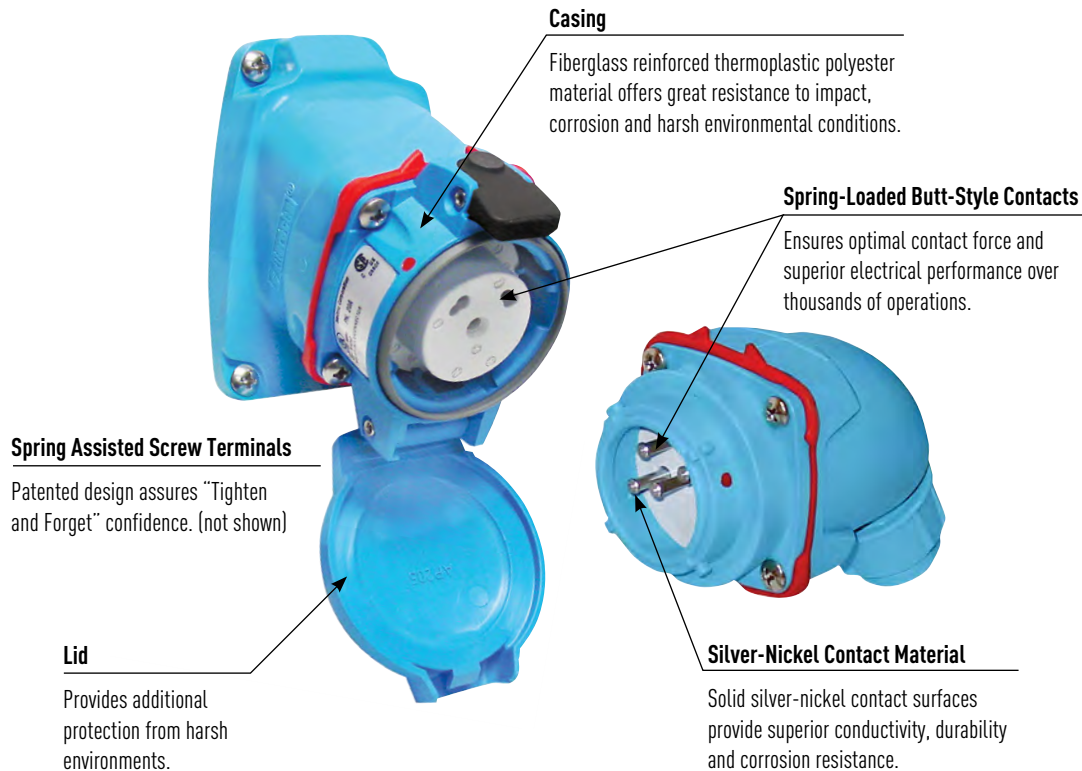

General Ratings

Amperage	20A
Voltage	600 VAC Max
Frequency	50-400 Hz
Environmental	IP66/IP67
Temperature	min -40°F/max 140°F (465° high temp model)

Current Interruption Listings

Model	Current Interruption Capabilities
PN20	For current interrupting

Highlighted Feature

PN Contact



PN devices feature silver-nickel, spring-loaded, butt-style contacts for superior durability and electrical performance.

Operating Instructions



To break the circuit and remove the plug, press the pawl, apply inward force and rotate the plug clockwise.



The plug can be safely withdrawn from the receptacle. The plug contacts remain shrouded until after the circuit is broken.



To reconnect, align the red dots on the plug and receptacle bodies, insert plug into the receptacle, apply insertion force and rotate the plug 20° counterclockwise.

Listings

Category	UL	CSA	IEC
Plugs and Receptacles	UL 1682*	C22.2 No. 182.1*	60309-1

* PN 20A devices are UL and CSA listed for current interrupting. PNHT devices are not UL/CSA listed.

PN20 Compact Plugs & Receptacles – 20A or 15A (600V)

UL/CSA Ratings

- **Max Amperage & Voltage**
20A, 600 VAC
- **Current Interruption Capability**
20A Current Interrupting (up to 480 VAC)
15A Current Interrupting (600 VAC)
- **Environmental Ratings**
Type 3R, Type 4X
- **Temperature Range**
Min -40°F/Max 140°F
See pg 271 for temps below -15°F.
- **Wiring Capacity**
Min 14 AWG Max 8 AWG
- **Certifications**
UL 1682, CSA 182.01

IEC/CE Ratings

- **Environmental Ratings**
IP66/IP67*, IP54/IP55**
* IP66/IP67 provides advanced watertightness for washdown duty applications.
** IP55 provides rainproof watertightness with ease of connection convenience.
- **Applicable Standards**
CE

Notes: • 600V devices are rated for current interrupting up to 15A only.

Receptacle female



! Don't forget to add installation accessories to your order

H IP55 receptacle comes without a pawl.

Inlet male



H The same male inlet is used for IP66/IP67 or IP55 watertight ratings.

North American UL/CSA Configurations

Voltage	Polarity	Part # IP66/IP67		Part # IP55		Part #	
		Poly	Metal	Poly	Metal	Poly	Metal
120V	1P+N+G	01-N4165	09-N4165	01-S4165	09-S4165	01-N8165	09-N8165
120 208V	3P+N+G	01-N4167	09-N4167	01-S4167	09-S4167	01-N8167	09-N8167
125V	1P+N+G	01-N4075	09-N4075	01-S4075	09-S4075	01-N8075	09-N8075
125 250V	2P+N+G	01-N4076	09-N4076	01-S4076	09-S4076	01-N8076	09-N8076
208V	2P+G	01-N4162	09-N4162	01-S4162	09-S4162	01-N8162	09-N8162
208V	3P+G	01-N4163	09-N4163	01-S4163	09-S4163	01-N8163	09-N8163
250V	2P+G	01-N4072	09-N4072	01-S4072	09-S4072	01-N8072	09-N8072
250V	3P+G	01-N4073	09-N4073	01-S4073	09-S4073	01-N8073	09-N8073
277V	1P+N+G	01-N4045	09-N4045	01-S4045	09-S4045	01-N8045	09-N8045
277 480V	3P+N+G	01-N4047	09-N4047	01-S4047	09-S4047	01-N8047	09-N8047
347 600V	3P+N+G	01-N4147	09-N4147	01-S4147	09-S4147	01-N8147	09-N8147
480V	2P+G	01-N4042	09-N4042	01-S4042	09-S4042	01-N8042	09-N8042
480V	3P+G	01-N4043	09-N4043	01-S4043	09-S4043	01-N8043	09-N8043
600V	2P+G	01-N4142	09-N4142	01-S4142	09-S4142	01-N8142	09-N8142
600V	3P+G	01-N4143	09-N4143	01-S4143	09-S4143	01-N8143	09-N8143

For international configurations and ratings (IEC,CE) visit meltric.com/international-catalog or contact customer service at 800.433.7642.

Main Options



Reverse Interiors



Flush Mount
(replaces female casing)



Locking Pawl

Receptacle Options

Suffix

Inlet Options

Suffix

Reverse Interiors

Recept # - 001

Reverse Interiors

Inlet # - 001

With Flush Mount (poly only)

Recept # - 142*

Locking Pawl

Recept # - 824-300

* IP55 rating with Flush Mount casing



! See pages 248-257 for detailed information on these options





Order Example: 480V PN20 IP66/IP67 + reverse interiors
PN20 Receptacle 3P+G = 01-N4043-001



INSTALLATION ACCESSORIES – SIZE 1

Unless indicated otherwise, accessories can be used with either poly or metal plugs and receptacles.

HANDLES

HANDLE w/NPT	Part # Poly	Part # Metal
 1/2"	511P0N05	591P0N05
 3/4"	511P0N07	591P0N07
 1"	511P0N10	591P0N10

HANDLE w/CORD GRIP	Cable Range	Poly	Metal
	.438 - .500"	711P0BP3	791P0BS3
	.500 - .562"	711P0BP4	791P0BS4
	.562 - .625"	711P0BP5	791P0BS5
	.625 - .750"	711P0CP4	791P0CS4

90° NYLON HANDLE Threaded Opening w/NPT	Part # Poly	Part # Metal
 1/2"	751P9N05	
 3/4"	751P9N07	
 1"	751P9N10	

NYLON HANDLE w/Cable Range	Part # Poly	Part # Metal
 .35 - .69"	511P0D18	

ANGLED NYLON HANDLE w/Cable Range	Part # Poly	Part # Metal
 .35 - .69"	511P6D18	

For available cord grips, see pg 178

Cable Range	NPT	NPT sizes are determined by the cable diameter and third party cord grip.
.312 - .625	1/2"	
.438 - .812	3/4"	
.660 - 1.000	1"	

ANGLES

NYLON ANGLE	Part # Poly	Part # Metal
 30° for MB Box	511M3	



METAL ANGLE	Part # Poly	Part # Metal
 0°	591M0	



FS/FD Box 30°	Part # Poly	Part # Metal
 FS/FD Box 30°	791M3FS	

* Base measures approximately 4.2" x 2.7". Due to the variation in sizes of FS boxes, please verify that your FS box matches our dimensions, if not call Customer Service for other solutions.

45°	Part # Poly	Part # Metal
	591M4	

BOXES

POLY CONDUIT ENTRY w/NPT	Part # Poly	Part # Metal
 30° 1/2"	511B3N05	
 30° 3/4"	511B3N07	



POLY WALL BOX w/NPT	Part # Poly	Part # Metal
 0° 1/2"	511B0N05	
 0° 3/4"	511B0N07	





METAL WALL BOX w/NPT	Part # Poly	Part # Metal
 0° 1/2"	591B0N05	
 0° 3/4"	591B0N07	





POLY WALL BOX w/NPT	Part # Poly	Part # Metal
 70° 1/2" - 1 1/4"	511C7000	

* 82.0 in³

70° poly boxes are not drilled. Contact customer service if factory drilling is required.

METAL BOX w/NPT	Part # Poly	Part # Metal
 0° 1/2"	7T1F0N05	
 0° 3/4"	7T1F0N07	
 0° 1"	7T1F0N10	
 0° 1 1/4"	7T1F0N12	

METAL BOX WITH NYLON ANGLE w/NPT	Part # Poly	Part # Metal
 30° 1/2"	711C3N05	
 30° 3/4"	711C3N07	
 30° 1"	711C3N10	
 30° 1 1/4"	711C3N12	

METAL BOX WITH METAL ANGLE w/NPT	Part # Poly	Part # Metal
 45° 1/2"	791C4N05	
 45° 3/4"	791C4N07	
 45° 1"	791C4N10	
 45° 1 1/4"	791C4N12	

NPT on top or bottom (if rotated). For other NPT configurations, contact customer service.

MISCELLANEOUS ACCESSORIES

PROTECTIVE CAP	Part # Poly	Part # Metal
 01-2A126	01-2A126	

For Male Devices Only.
Will not fit devices with reverse interiors.

FLUSH MOUNT	Part # Poly	Part # Metal
 01-2A142	01-2A142	

PN SPARE PARTS Male Configuration

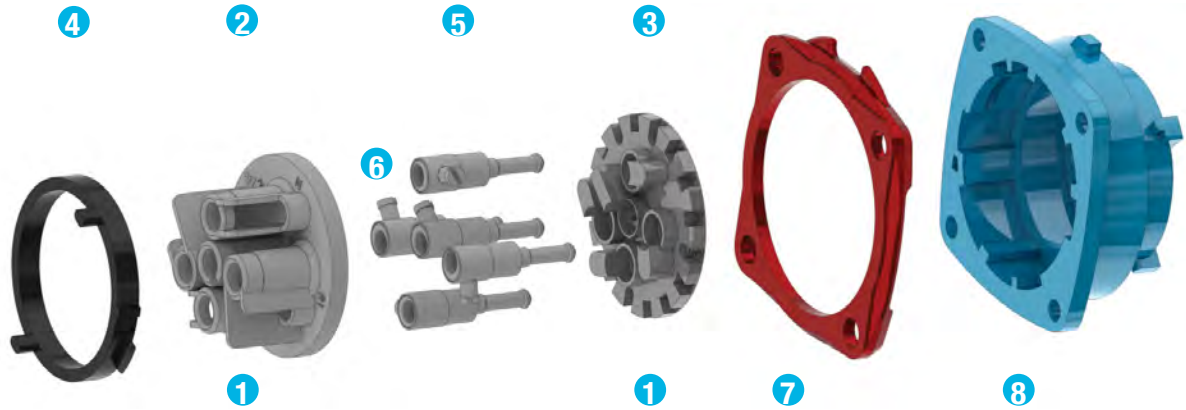

		PN20 POLY	PN20 METAL	PNHT HT METAL
1	Plug Interior**	01-2A010*	01-2A010*	01-2A010-185*
2	Interior Bottom**	01-2A010-B	01-2A010-B	01-2A010-185-B
3	Interior Top**	01-2A010-T*	01-2A010-T*	01-2A010-185-T*
4	Locking Ring	01-NA583	09-2A583	09-2A583-185
4	Plug Contact	01-2A011	01-2A011	01-2A011-185
5	Ground Contact	01-2A019	01-2A019	01-2A019-185
6	Color-Coded Voltage Gasket	125V	61-1AC26	-
		208V	61-1AB26	-
		250V	61-1AC26	-
		480V	61-1AR26	-
7	Plug Casing	01-NA014**	09-NA014**	09-2A014-185**

* Voltage and phasing positions must be specified (5th, 6th & 7th digit of Part #) to duplicate your shutter and alignment notches.

** For appropriate labeling on a device, please specify voltage, phasing, and product type.

PN SPARE PARTS Female Configuration

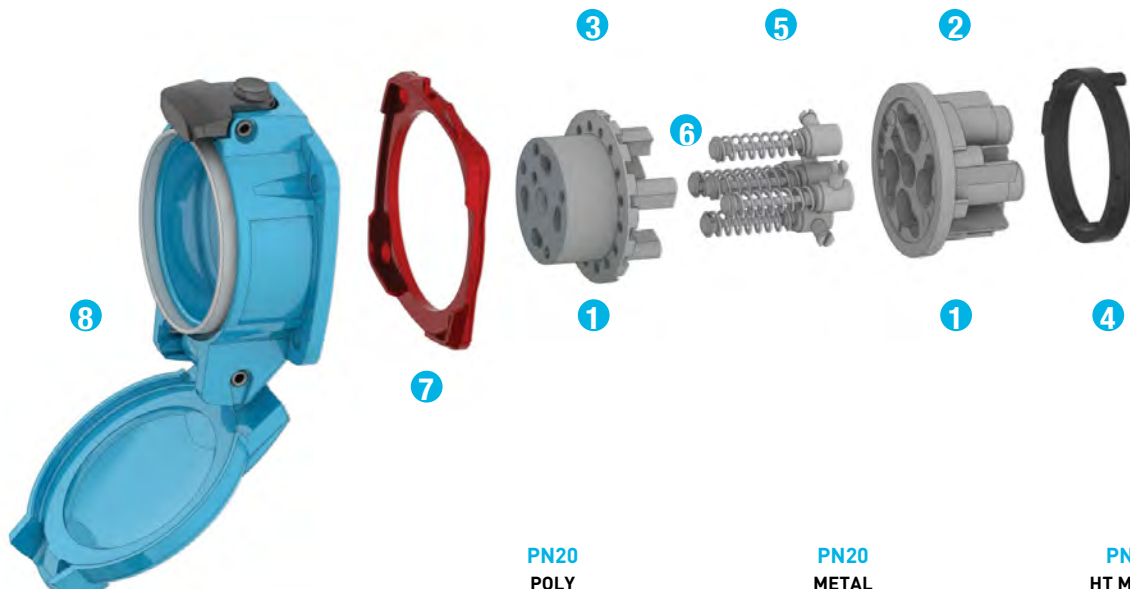

		PN20 POLY	PN20 METAL	PNHT HT METAL
1	Receptacle Interior	01-2A020*	01-2A020*	01-2A020-185*
2	Interior Bottom	01-2A020-B	01-2A020-B	01-2A020-185-B
3	Interior Top	01-2A020-T*	01-2A020-T*	01-2A020-185-T*
4	Locking Ring	01-NA583	09-2A583	09-2A583-185
5	Receptacle Contact	01-2A021	01-2A021	01-2A021-185
5	Ground Contact	01-2A029	01-2A029	01-2A029-185
6	Color-Coded Voltage Gasket	125V	61-1AC26	-
		208V	61-1AB26	-
		250V	61-1AC26	-
		480V	61-1AR26	-
7	Receptacle Casing w/Lid IP54/IP55	01-SA024**	09-SA024**	09-2A024-185**
7	Receptacle Casing w/Lid IP66/IP67	01-NA024**	09-NA024**	-

* Voltage and phasing positions must be specified (5th, 6th & 7th digit of Part #) to duplicate your shutter and alignment notches.

** For appropriate labeling on a device, please specify voltage, phasing, and product type.

PN DIMENSIONS – Provided in inches

Dimensions are for reference only and may change depending on accessories used. For precise dimensions contact MELTRIC Engineering.

Plug

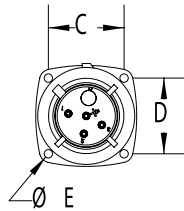
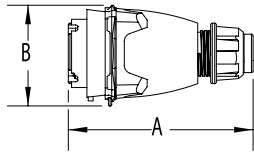

Inlet

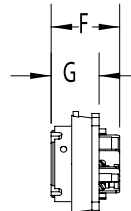

Plug Angled Handle

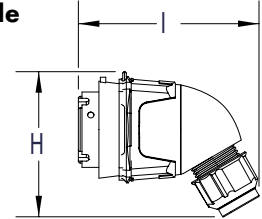

PRODUCT	A	B	C	D	ØE	F	G	H	I
PN	4.33	2.4	16.5	1.65	0.18	1.5	1.14	3.9	3.17

Connector

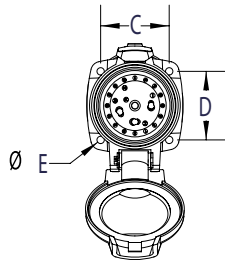
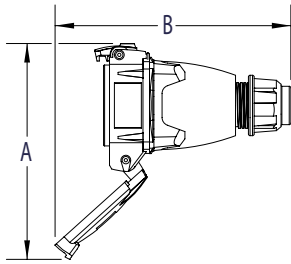

Receptacle

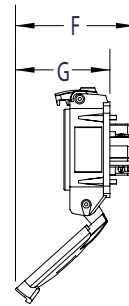

Connector Angled Handle

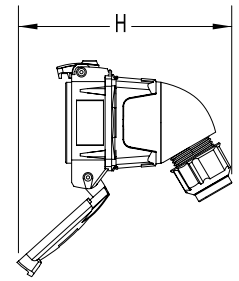

PRODUCT	A	B	C	D	E	F	G	H
PN	5.51	5.69	1.65	1.65	0.18	1.93	1.38	4.17

Box/30° Angle/Receptacle/Plug

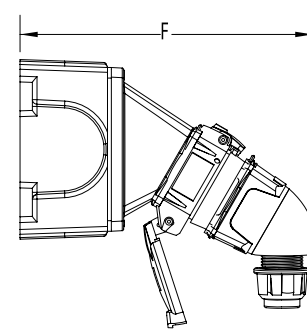
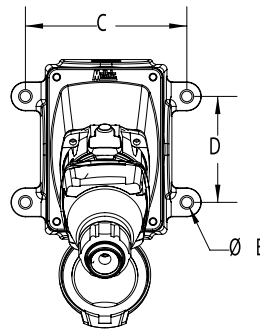
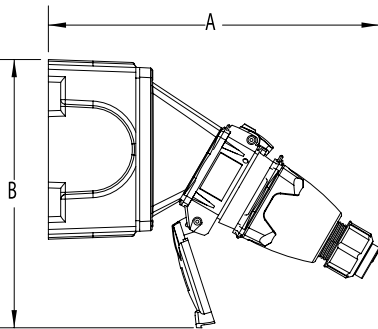

PRODUCT	A	B	C	D	E	F
PN	8.59	6.96	4.19	2.75	0.27	7.6

30° Angle/Receptacle/Plug

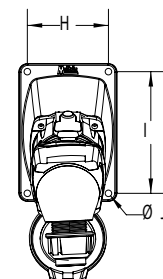
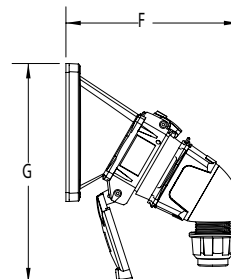
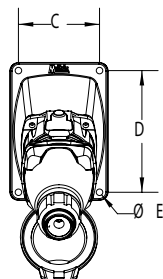
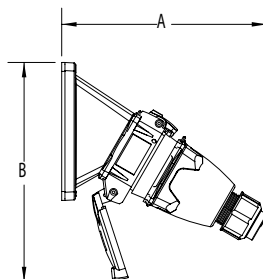

PRODUCT	A	B	C	D	ØE	F	G	H	I	ØJ
PN	6.32	6.76	2.5	3.75	0.2	5.33	6.76	2.5	3.75	0.2



70° Wall Box/ Receptacle

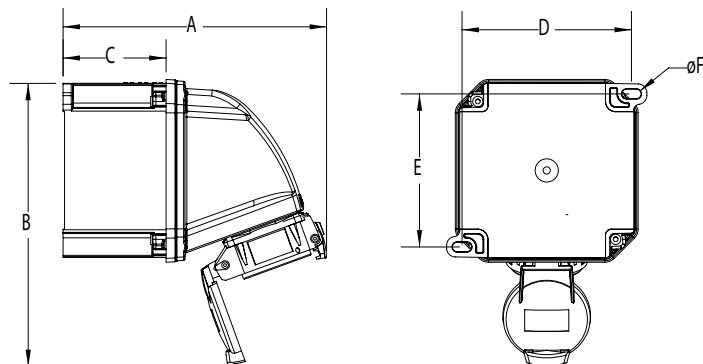

PRODUCT	A	B	C	D	E	ØF
PN	7.15	7.68	2.80	4.60	4.15	0.26

Straight Wall Box/Receptacle/Plug

Straight Wall Box/Receptacle/ Plug/Angled Handle

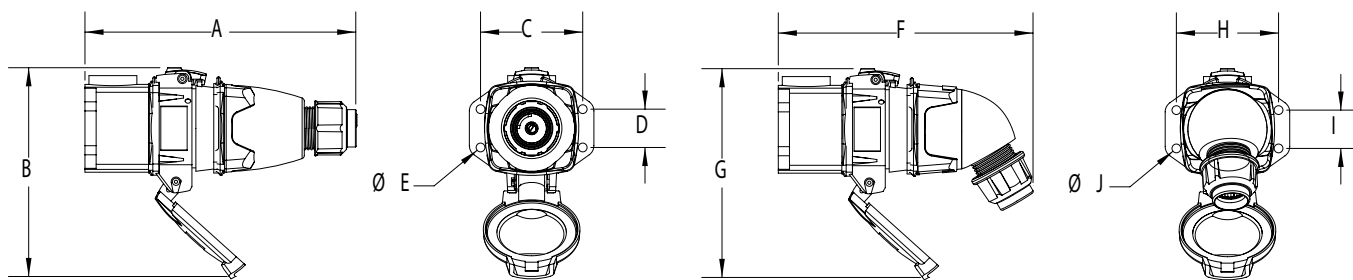

PRODUCT	A	B	C	D	ØE	F	G	H	I	ØJ
PN	6.68	5.15	2.52	0.95	0.22	6.28	5.15	2.52	0.95	0.22

Connector/Plug

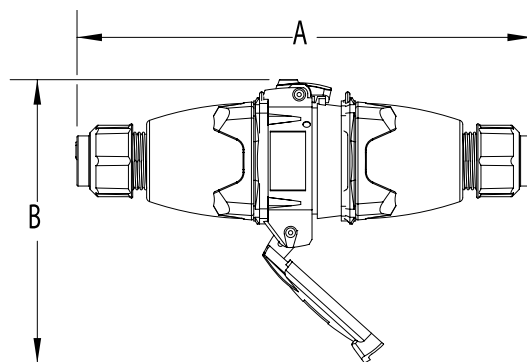

PRODUCT	A	B
PN	8.37	5.21



PNHT High Temperature plug and receptacle



Main Advantages

- ▶ Compact yet durable device
- ▶ Spring-loaded silver-nickel devices
- ▶ Spring-assisted terminals resist vibrations and thermal cycling



- ▶ **Features and Ratings** p. 123
- ▶ **PNHT** p. 124

PRODUCT FEATURES



Operating Instructions

Connection



Ensure that the circuit is deenergized before removing the plug from the receptacle.



To remove the plug, apply slight inward force and rotate the plug counterclockwise.

Disconnection



To reconnect open lid, align grooves in inlet with notches in the receptacle casing.



Insert and twist clockwise until plug is engaged.

General Ratings

Amperage	30A
Voltage	480 VAC Max
Environmental	IP44
Temperature	max 465°F (240°C)

This high-temperature version of the PN is approved for use in temperatures up to 465°F / 240°C.

Therefore, you can supply power to electrical equipment located next to heat sources: machines, industrial facilities, steel works, metallurgy, etc.

PNHT High Temperature Plugs & Receptacles – 30A

UL/CSA Ratings

- **Max Amperage & Voltage**
30A, 480 VAC, 130 VDC
 - **Not for Current Interruption**
Not for current interrupting
 - **Environmental Ratings**
IP44
 - **Temperature Range**
Min -40°F / Max 465°F
 - **Wiring Capacity**
Min 14 AWG Max 8 AWG
 - **Certifications**
IEC, CE*
- *Contact Customer Service

Receptacle (female)



Inlet (male)



! Don't forget to add installation accessories to your order

North American UL/CSA Configurations

Voltage	Polarity	Part # Metal	Part # Metal
125V	1P+N+G	09-24075-185	09-28075-185
250V	2P+G	09-24072-185	09-28072-185
125 250V	2P+N+G	09-24076-185	09-28076-185
250V	3P+G	09-24073-185	09-28073-185
125 250V	3P+N+G	09-24077-185	09-28077-185
277V	1P+N+G	09-24045-185	09-28045-185
480V	2P+G	09-24042-185	09-28042-185
480V	3P+G	09-24043-185	09-28043-185
277 480V	3P+N+G	09-24047-185	09-28047-185

For international configurations and ratings (IEC,CE) visit meltric.com/international-catalog or contact customer service at 800.433.7642.

! See pages 248-257 for detailed information on these options

INSTALLATION ACCESSORIES – SIZE 1

Unless indicated otherwise, accessories can be used with either poly or metal plugs and receptacles.

HANDLES

METAL HANDLE w/Threaded Opening w/NPT	Part #
 1/2"	571P0N05185
3/4"	571P0N07185
1"	571P0N10185

HANDLE w/CORD GRIP	Cable Range	Part #
	.28 - .51"	571P020M185
	.31 - .63"	571P025M185
	.71 - 1.10"	571P032M185

For available cord grips, see pg 178

BOXES



METAL WALL BOX w/NPT	Part #
 0° 1/2"	571B0N05185
0° 3/4"	571B0N07185

METAL BOX w/NPT	Part #
 0° 1/2"	771F0N05
0° 3/4"	771F0N07
0° 1"	771F0N10
0° 1 1/4"	771F0N12

METAL BOX WITH METAL ANGLE w/NPT	Part #
 45° 1/2"	771C4N05185
45° 3/4"	771C4N07185
45° 1"	771C4N10185
45° 1 1/4"	771C4N12185

NPT on top or bottom (if rotated). For other NPT configurations, contact customer service.

ANGLES

METAL ANGLE	Part #
 0°	571M0
 45°	571M4185

i

Cable Range	NPT	
.312 - .625	1/2"	NPT sizes are determined by the cable diameter and third party cord grip.
.438 - .812	3/4"	
.660 - 1.000	1"	



DSDC

DC rated
plug and receptacle

Main Advantages

- ▶ Rated for Direct Currents
- ▶ Standard locking feature enables locking in the connected and disconnected mode
- ▶ Robust Metal or Poly construction



- ▶ **Features and Ratings** p. 127
- ▶ **DSDC** p. 128

PRODUCT FEATURES

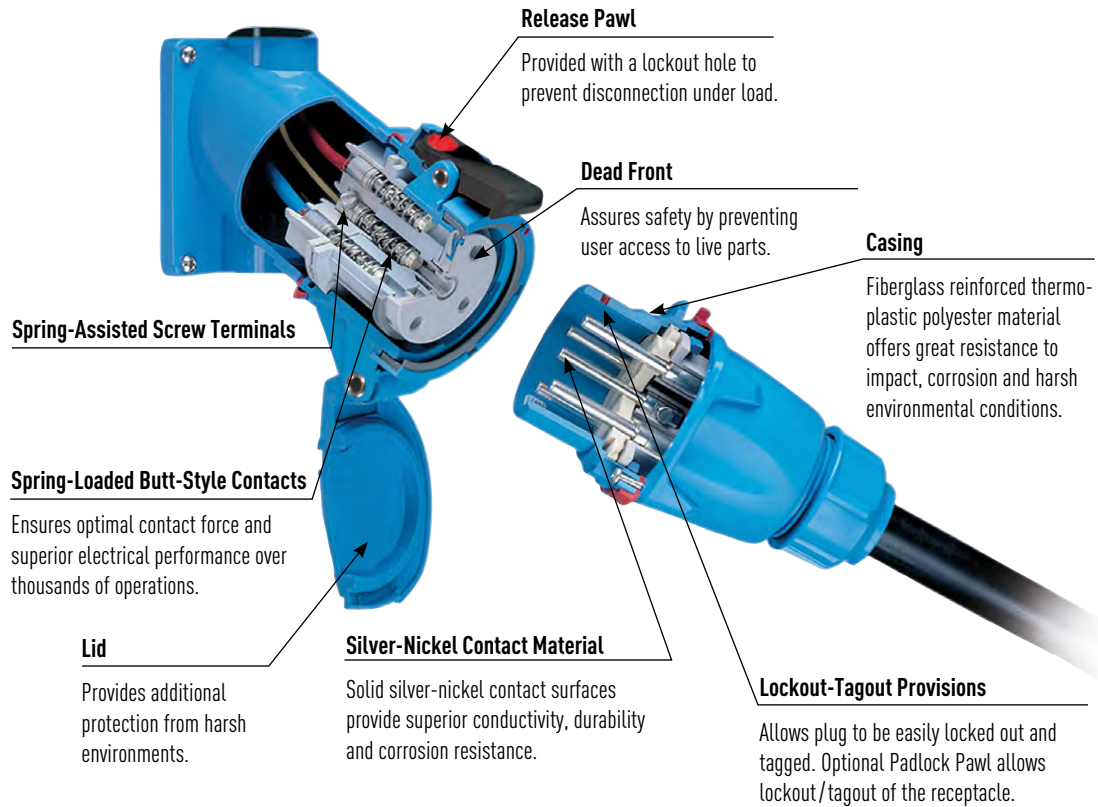

General Ratings

Amperage	130 VDC: 20 to 200A
	250 VDC: 20 to 200A
	600 VDC: 15 to 100A
	750 VDC: 10 to 30A
Voltage	130 VDC, 250 VDC, 600 VDC or 750 VDC
Environmental	Type 3R, IP54/IP55**, Type 4X optional
Temperature	min -40°F/max 140°F

** IP54 rated when receptacle and plug are mated, when not mated receptacle alone is IP55 rated provided that the lid is latched closed.

Highlighted Feature

Receptacle Lockout Hole



All DSDC models are provided with a lockout hole in the pawl. This feature allows locking of the receptacle to prevent accidental disconnection of the plug under load.

Operating Instructions

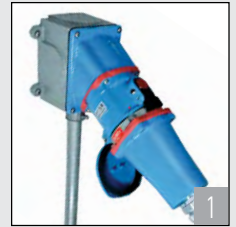

When a DSDC is under load the receptacle should be locked to prevent disconnection.



If the DSDC is NOT under load, it can be disconnected by pressing the pawl.



A quarter turn of the plug allows it to be totally withdrawn from the receptacle. This is done in complete safety as the circuit is already dead.



The plug and the receptacle are separated. The safety shutter prevents access to live parts.

5 To reconnect, insert plug into receptacle, rotate 30° clockwise, and apply insertion force.

Listings

Category	UL	CSA
Plugs and Receptacles	UL 1682	C22.2 No. 182.1

CE ratings available upon request.

Standard Duty Plugs & Receptacles 130V, 250V, 600V, 750V

UL/CSA Ratings

- **Max Amperage & Voltage**
200A, 750 VDC
- **Current Interruption Capability**
Not for current interrupting
- **Environmental Ratings**
Type 3R, IP54/IP55*
* IP54 when the plug & receptacle are mated. IP55 on the receptacle alone when the lid is latched closed.
- **Temperature Range**
Min -40°F/Max 140°F
See pg 271 for temps below -15°F.
- **Wiring Capacity**
DSDC1 Min 14 AWG Max 8 AWG
DSDC3 Min 14 AWG Max 6 AWG
DSDC6 Min 10 AWG Max 2 AWG
DSDC9 Min 6 AWG Max 2/0 AWG
DSDC2 Min 4 AWG Max 4/0 AWG
- **Certifications**
UL 1682 (130, 250 & 600 VDC)
CSA 182.1 listed up to 250 VDC
750 VDC devices pass UL testing, but are outside the scope of the standard so they cannot be listed.

**Receptacle
(female)**



**Inlet
(male)**



! Don't forget to add installation accessories to your order

North American UL/CSA Configurations

Voltage	Polarity	Part #		Part #		
		Poly	Metal	Poly	Metal	
DSDC1	130V/20A	2P+G	33-14109	-	33-18109	-
DSDC3	130V/30A	2P+G	33-34109	-	33-38109	-
DSDC6	130V/60A	2P+G	33-64109	37-64109	33-68109	37-68109
DSDC9	130V/100A	2P+G	33-94109*	37-94109*	33-98109*	37-98109*
DSDC2	130V/200A	2P+G	-	37-24109	-	37-28109
DSDC1	250V/20A	2P+G	33-14209	-	33-18209	-
DSDC3	250V/30A	2P+G	33-34209	-	33-38209	-
DSDC6	250V/60A	2P+G	33-64209	37-64209	33-68209	37-68209
DSDC9	250V/100A	2P+G	33-94209*	37-94209	33-98209*	37-98209*
DSDC2	250V/200A	2P+G	-	37-24209	-	37-28209
DSDC1	600V/15A	2P+G*	33-14058-S82	-	33-18058-S82	-
DSDC3	600V/30A	2P+G*	33-34058-S82	-	33-38058-S82	-
DSDC6	600V/50A	2P+G*	33-64058-S82	37-64058-S82	33-68058-S82	37-68058-S82
DSDC9	600V/60A	2P+G*	33-94058-S82*	-	33-98058-S82*	-
DSDC2	600V/100A	2P+G*	-	37-24058-S82	-	37-28058-S82
DSDC1	750V/10A	2P+G*	33-14158-S69	-	33-18158-S69	-
DSDC3	750V/20A	2P+G*	33-34158-S69	-	33-38158-S69	-
DSDC6	750V/30A	2P+G*	33-64158-S69	37-64158-S69	33-68158-S69	37-68158-S69

Notes: * Type 4x as standard
* Polarity for connection purposes. Devices have additional contacts used for load splitting. See information below.

For international configurations and ratings (IEC,CE) visit meltric.com/international-catalog or contact customer service at 800.433.7642.

Receptacle Options Part

- Type 4X Watertightness **Recept # - 4X**
- Metal Pawl (on poly receptacle) **Recept # - 824**
- Closed Lid Configuration **Recept # - NC**

DSDC2 models are also provided with a screw locking pawl to provide an alternative means of preventing accidental disconnection under load.

Inlet Options Part

- Type 4X Watertightness **Inlet # - 4X**
- With no Lockout Hole **Inlet # - A155**

! See pages 248-257 for detailed information on these options

Jumpers provided on 600 VDC and 750 VDC models

Jumpers are required on all 600 VDC and 750 VDC models as a safety precaution to split the arc in case of accidental disconnection under load. Plugs and receptacles are provided with jumpers installed. Receptacles utilize a jumper between N and L3 poles. Plugs utilize a jumper between L2 and N poles.

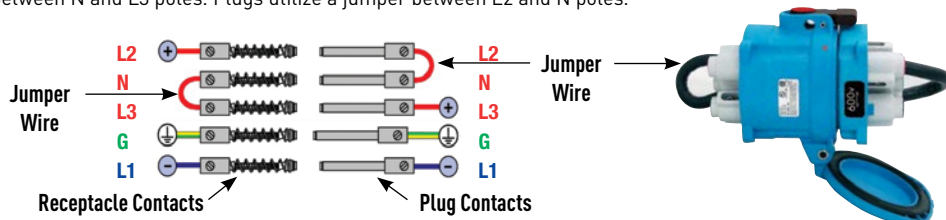

INSTALLATION ACCESSORIES

Unless indicated otherwise, accessories can be used with either poly or metal plugs and receptacles.

HANDLES



Nylon Handle



Poly Handle



Poly Handle

DSDC1, 3, 6 shown

DSDC9, 2 shown

	Cable Range	Nylon Handle	1/2" NPT	3/4" NPT	1" NPT	1 1/4" NPT	1 1/2" NPT	2" NPT	2 1/2" NPT
DSDC1	.20 - .83	512P0D21	512P0N05	512P0N07	512P0N10	512P0N12	-	-	-
DSDC3	.39 - 1.18	513P0D30	513P0N05	513P0N07	513P0N10	513P0N12	-	-	-
DSDC6	.51 - 1.38	514P0D35	514P0N05	514P0N07	514P0N10	514P0N12	514P0N15	-	-
DSDC9	-	-	-	515P0N07	515P0N10	515P0N12	515P0N15	515P0N20	-
DSDC2	-	-	-	-	-	-	516P0N15	516P0N20	516P0N25

- Notes:**
- Finger draw plates are recommended for easier connector closure on cord to cord assemblies.
 - For available cord grips, see pgs 178.

BOXES



Metal Box

DSDC1, 3, 6 shown



Metal Box

DSDC9, 2 shown

	1/2" NPT	3/4" NPT	1" NPT	1 1/4" NPT	1 1/2" NPT	2" NPT	2 1/2" NPT
DSDC1	7T1F0N05	7T1F0N07	7T1F0N10	7T1F0N12	-	-	-
DSDC3	7T1F0N05	7T1F0N07	7T1F0N10	7T1F0N12	-	-	-
DSDC6	-	-	7T4F0N10	7T4F0N12	7T4F0N15	7T4F0N20	-
DSDC9	-	-	-	7T5F0N12	7T5F0N15	7T5F0N20	7T5F0N25
DSDC2	-	-	-	-	7T6F0N15	7T6F0N20	7T6F0N25

NPT on top or bottom (if rotated).
For other NPT configurations, contact customer service.



Poly Conduit Box For poly devices only

	1/2" NPT	3/4" NPT	1" NPT	1 1/4" NPT
DSDC1	512B3N05	512B3N07	-	-
DSDC3	513B3N05	513B3N07	513B3N10	-
DSDC6	514B3N05	514B3N07	514B3N10	514B3N12

For DSDC dimensions use the cross reference chart below and refer to DS dimensions on pgs 54-55.

Dimensions	
DSDC1	same as DS20
DSDC3	same as DS30
DSDC6	same as DS60
DSDC9	same as DS100
DSDC2	same as DS200

ANGLES



	Nylon 30° Angle	Metal 30° Angle	Metal Angle FS/FD Box 30°	Metal Straight Adapter	Poly 70°*** Wall Box
DSDC1	512M3	592M3	792M3FS*	592M0	512C7000
DSDC3	513M3	593M3	793M3FS*	593M0	513C7000
DSDC6	514M3	594M3	-	594M0	514C7000
DSDC9	515M3	595M3	-	595M0	-
DSDC2	-	596M6 (60°)	-	596M0	-



* Set of Two (2)



For Male Devices Only



For Male Devices Only



MISC. ACCESSORIES

	Finger Drawplates	Protective Cap	Padlockable Cap Poly	Inlet Spring-loaded Cap
DSDC1	61-3A346	31-1A426	DS1PC	31-1A226
DSDC3	61-6A346	31-3A426	DS3PC	31-3A226
DSDC6	31-6A346	31-6A426	DS6PC	31-6A226
DSDC9	**	35-9A126	DS9MC***	-
DSDC2	**	35-2A126	DS2MC***	-

* MAFS2 and MAFS3 base measures approximately 4.2" x 2.7". Due to the variation in sizes of FS boxes, please verify that your FS box matches our dimensions, if not call Customer Service for other solutions.
** 70° boxes are not drilled. Contact customer service if factory drilling is required.

* Recommended for cord to cord assembly applications, for easier connector closure.
** An easy closing mechanism is standard on DSDC9 and DSDC2.
*** Padlockable Cap Aluminum – Not pictured.

HIGH AMPACITY

Plugs & Receptacles



High Amperage plugs and receptacles from MELTRIC offer superior safety and performance in harsh environments. Each high amperage product line features MELTRIC's exclusive contact technology along with advanced safety features and relatively easy plug insertion and removal.



PF/PFQ P. 132

THREE PHASE, TWIST TO CONNECT

- 300A to 600A
- Silver pressure contacts
- Mechanical locking system



DR400 P. 140

THREE PHASE, EASY PLUG INSERTION

- 400A, 480V or 350A, 600V
- Silver nickel, Spring-loaded, butt-style contacts
- Easy closing mechanism



SP P. 144

SINGLE POLE, EXCLUSIVE SAFETY FEATURES

- 600A (CSA), 700A, (IEC)
- Silver, butt-style contacts
- Integral pilot circuit



CS1000 P. 148

SINGLE POLE, EASY TO OPERATE

- 400A, 600V
- Silver nickel, Spring-loaded, butt-style contacts
- Locking pin prevents accidental disconnects

PF/PFQ High Amperage plug and receptacle



Main Advantages

- ▶ Durable in harsh environments
- ▶ Safety features provide maximum protection
- ▶ Easy plug insertion and removal



Watch the PF video and other product videos at meltric.com/video

- ▶ Features and Ratings p. 133
- ▶ PF/PFQ 300-600A p. 134
- ▶ PF/PFQ Lugs p. 136
- ▶ Spare parts p. 138
- ▶ Dimensions p. 139

 **PFQ300** devices are differentiated from similarly rated **PF300** devices in their smaller size, lighter weight and additional pilot contacts.

PRODUCT FEATURES

Auxiliary Pilot Contacts

Provided for use with control circuits. They close after and open before the phase contacts.

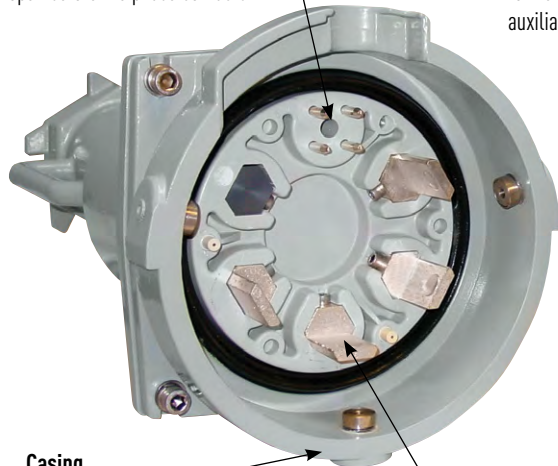

Mechanical Locking System

Ensures safety and watertightness. Mechanical lock secures the inlet to the receptacle and engages the auxiliary/pilot contacts.



Casing

Epoxy/powder coated aluminum material offers great resistance to harsh environments.

Silver Pressure Contacts

Silver material and self-cleaning action provides maximum conductivity and performance in dirty and corrosive conditions.

Safety Shutter

Protects recessed female contacts and inhibits user access to live parts.

Operating Instructions



PF devices are preferred for the ease of operation relative to pin and sleeve devices.

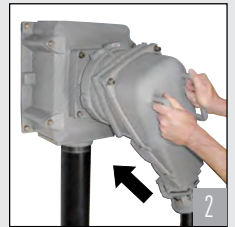

Insert the plug into the receptacle – this is done with little resistance relative to competitive devices.



Twist plug approximately 30° clockwise to engage the phase contacts and make unit watertight.



Turning the mechanical lock secures the inlet to the receptacle and engages the pilot contacts which energize the circuit.

5 To disconnect, turn mechanical lock to disengage pilot contacts and de-energize the circuit. Twist plug 30° counterclockwise to disengage the phase contacts, withdraw plug.

HIGH AMPACITY

General Ratings

Amperage	300 to 600A
Voltage*	1000 VAC*, 1000 VDC Max
Frequency	50-400 Hz (not UL at 50 Hz)
Environmental	IP66/IP67
Temperature	min -40°F/max 140°F

* 600 VAC max for PFQ devices

* IUL listings do not apply above 600 VAC and 250 VDC.

Listings

Category	UL	CSA
Plugs and Receptacles	UL 1682	C22.2 No. 182.1

* Listings only apply to 300A and 400A devices at 600v or less.

Highlighted Feature

Pilot Contacts

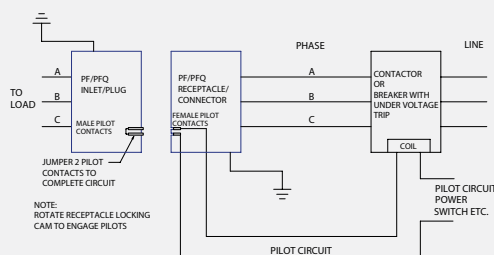

Line diagram of typical PF pilot control circuit

For multiple devices in a parallel circuit, contact factory for example control circuit diagrams.

Category	PF	PFQ
# Contacts	4	8
Pilot Amperage	10A standard duty	5A @ 240VAC
Interlocking Type	Mechanical	Mechanical
Terminal Type	Screw	Solder/crimp

- Notes:**
- The mechanical locking of the plug to the receptacle via the rotation of a cam, closes the pilot contacts.
 - Failure to use a pilot/relay system can create an electrical shock hazard.

PF/PFQ High Ampacity Plugs & Receptacles

300A-600A

UL/CSA Ratings

- **Max Amperage & Voltage**
PF = 600A, 1000 VAC*, 250 VDC
PFQ = 300A, 600 VAC, 250 VDC
- **Current Interruption Capability**
Not for current interrupting
- **Environmental Ratings**
IP66/IP67
- **Temperature Range**
Min -40°F / Max 140°F
See pg 271 for temps below -15°F.
- **Wiring Capacity**
PFQ = 2 AWG to 600 MCM
PF = 2 AWG to 600 MCM
- **Certifications**
UL 1682*, CSA 182.1*
* Listings apply only to 300A & 400A devices at 600V or less

! PF/PFQ devices are not intended for connection or disconnection under load. To prevent live making or breaking electrical interlocking is required.

Receptacle/Cap 300A (female)



Inlet/Cap 300A (male)



! Don't forget to add installation accessories to your order

North American UL/CSA Configurations

Voltage	Polarity	Part #		Part #	
		PFQ 300**	PF300	PFQ 300**	PF300
277V	1P+N+G	47-34045	49-34045	47-38045	49-38045
347V	1P+N+G	47-34145	49-34145	47-38145	49-38145
480V	2P+G	47-34042	49-34042	47-38042	49-38042
480V	2P+N+G	47-34046	49-34046	47-38046	49-38046
480V	3P+G	47-34043	49-34043	47-38043	49-38043
480V	3P+N+G	47-34047	49-34047	47-38047	49-38047
600V	2P+G	47-34142	49-34142	47-38142	49-38142
600V	2P+N+G	47-34146	49-34146	47-38146	49-38146
600V	3P+G	47-34143	49-34143	47-38143	49-38143
600V	3P+N+G	47-34147	49-34147	47-38147	49-38147

** PFQ300 devices are differentiated from similarly rated PF300 devices in their smaller size, lighter weight and different pilot contacts.

For international configurations and ratings (IEC,CE) visit meltric.com/international-catalog or contact customer service at 800.433.7642.

Main Options Part

Receptacle with no cap	Recept # - 48
Receptacle with lockout hole	Recept # - 843
Inlet with no cap	Inlet # - 48
Inlet with lockout hole	Inlet # - 843

Notes: • Metal caps are provided as standard with male and female devices.

- Heat shrink wrap is provided with each inlet and receptacle to provide insulation between terminals.
- **Lugs are not included.** The PF and PFQ contacts utilize bolt-on lug type wire terminals, which require a compression lug with a 9/16" or 5/8" hole. The angled handle requires straight lugs; the straight handle requires 90° lugs.

! See pages 248-257 for detailed information on these options

Receptacle/Cap 400A/600A (female)



Inlet/Cap 400A/600A (male)







North American UL/CSA Configurations

Voltage	Polarity	Part #		Part #	
		PF400	PF600	PF400	PF600
277V	1P+N+G	49-44045	49-64045	49-48045	49-68045
347V	1P+N+G	49-44145	49-64145	49-48145	49-68145
480V	2P+G	49-44042	49-64042	49-48042	49-68042
480V	2P+N+G	49-44046	49-64046	49-48046	49-68046
480V	3P+G	49-44043	49-64043	49-48043	49-68043
480V	3P+N+G	49-44047	49-64047	49-48047	49-68047
600V	2P+G	49-44142	49-64142	49-48142	49-68142
600V	2P+N+G	49-44146	49-64146	49-48146	49-68146
600V	3P+G	49-44143	49-64143	49-48143	49-68143
600V	3P+N+G	49-44147	49-64147	49-48147	49-68147

For international configurations and ratings (IEC,CE) visit meltric.com/international-catalog or contact customer service at 800.433.7642.

INSTALLATION ACCESSORIES – SIZE C & F

HANDLES

METAL STRAIGHT HANDLE			Part #
PF shown	PFQ300	0°	47-3A013-XXX
	PF300	0°	49-3A013-XXX
	PF400	0°	49-4A013-XXX
	PF600	0°	49-6A013-XXX
Metal Angled Handle			
PF shown	PFQ300	90°	47-3A913-XXX
	PF300	90°	49-3A913-XXX
	PF400	90°	49-4A913-XXX
	PF600	90°	49-6A913-XXX
NPT Adapter	NPT Size	XXX (Suffix #)	
	2.0"	-N20	For available cord grips, see pg 178.
	2.5"	-N25	
	3.0"	-N30	
Standard Clamp w/Cable Range			
	2.000 - 2.125"	-200	
	2.125 - 2.250"	-225	
	2.250 - 2.375"	-237	
	2.375 - 2.500"	-250	
	2.500 - 2.750"	-275	
	2.750 - 3.000"	-300	
	3.000 - 3.125"	-312	
	3.125 - 3.350"	-335	
	3.350 - 3.577"	-350	

Accessory Spotlight

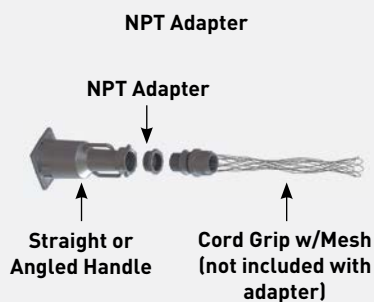

A NPT adapter accessory allows the user to connect a third party cord grip to the PF/PFQ handle.

BOXES

METAL JUNCTION BOX			Part #	
	PFQ300	See table	MB40PFQ-XX	This box is a heavy duty powder coated Aluminum back box with removable cover. Conduit entry hub up to 4" NPT can be ordered on one or both ends or even on the back of the enclosure. Multiple hubs and sizes can be ordered for installs with parallel entry's on one end of the box.
	PF300	See table	MB40-XX	
	PF400	See table	MB40-XX	
	PF600	See table	MB40-XX	

Hub Sizes	Fitting Size	XX (Suffix #)
	2.0"	-20
	2.5"	-25
	3.0"	-30
	3.5"	-35
	4.0"	-40

STAINLESS STEEL JUNCTION BOX		PFQ	PF	
	2.0"	47-4A023-N020	49-6A023-N020	These enclosures offer additional interior volume for extra wiring space. Both size enclosures have two removable covers and a one piece back pan installed for customer convenience. Conduit entry up to 4" NPT is limited to the bottom of the enclosure.
	2.5"	47-4A023-N025	49-6A023-N025	
	3.0"	47-4A023-N030	49-6A023-N030	
	4.0"	47-4A023-N040	49-6A023-N040	

STAINLESS STEEL JUNCTION BOX		PFQ	PF	
	2.0"	47-4A023-N520	49-6A023-N520	These enclosures offer additional interior volume for extra wiring space. Both size enclosures have two removable covers and a one piece back pan installed for customer convenience. Conduit entry up to 4" NPT is limited to the bottom of the enclosure.
	2.5"	47-4A023-N525	49-6A023-N525	
	3.0"	47-4A023-N530	49-6A023-N530	
	4.0"	47-4A023-N540	49-6A023-N540	

MISCELLANEOUS ACCESSORIES

INLET METAL CAP		
	PFQ300	47-3A126
	PF300	49-3A126
	PF400	49-4A126
PF shown	PF600	49-6A126

RECEPTACLE METAL CAP		
	PFQ300	47-3A925
	PF300	49-3A925
	PF400	49-4A925
	PF600	49-6A925

WEIGHTS

PART	PF	PFQ
Inlet	15 lbs	9 lbs
Receptacle	25 lbs	12 lbs
Angled Handle	15 lbs	12 lbs
Straight Handle	10 lbs	10 lbs
Junction Box	45 lbs	45 lbs
Cap	3 lbs	3 lbs
Stainless Steel Box	85 lbs	55 lbs

PF/PFQ High Ampacity Plugs & Receptacles

300A-600A

Straight Barrel Lugs

! MELTRIC recommends using lugs with tangs that do not exceed 1 3/4".



! Lugs are not included with PF/PFQ devices - order separately

Part #	Wire Size
PFLUG4	4 AWG
PFLUG3	3 AWG
PFLUG2	2 AWG
PFLUG1	1 AWG
PFLUG10	1/0 AWG
PFLUG20	2/0 AWG
PFLUG30	3/0 AWG
PFLUG40	4/0 AWG
PFLUG250	250kcmil
PFLUG300	300kcmil
PFLUG350	350kcmil
PFLUG400	400kcmil
PFLUG500	500kcmil
PFLUG600	600kcmil
PFLUG650	650kcmil

Application Note

Installation Accessory: Angled Handle



Straight Barrel Lugs are utilized on PF/PFQ devices along with angled handles.



Typical wiring of a PF male inlet for angled handle applications.

H Apply heat shrink over lugs at terminals (supplied but not shown).

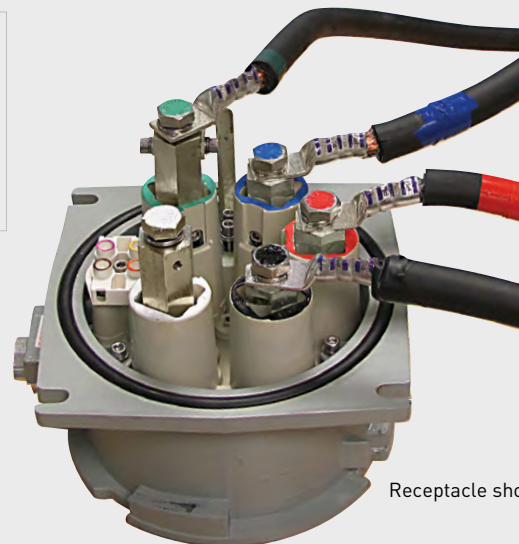

Receptacle shown

90° Bent/Angle Lugs



! Lugs are not included with PF/PFQ devices - order separately

! MELTRIC recommends using lugs with tangs that do not exceed 1 3/4".

Part #	Wire Size
PFLUG4-90	4 AWG
PFLUG3-90	3 AWG
PFLUG2-90	2 AWG
PFLUG1-90	1 AWG
PFLUG10-90	1/0 AWG
PFLUG20-90	2/0 AWG
PFLUG30-90	3/0 AWG
PFLUG40-90	4/0 AWG
PFLUG250-90	250kcmil
PFLUG300-90	300kcmil
PFLUG350-90	350kcmil
PFLUG400-90	400kcmil
PFLUG500-90	500kcmil
PFLUG600-90	600kcmil

Application Note

Installation Accessory: Straight Handle



90° Bent Lugs are utilized on PF/PFQ devices along with straight handles.

HIGH AMPACITY



Typical wiring of a PF male inlet for straight handle applications.

H Apply heat shrink over lugs at terminals (supplied but not shown).



Inlet shown



PF/PFQ SPARE PARTS

Male Configuration

PFQ pictured

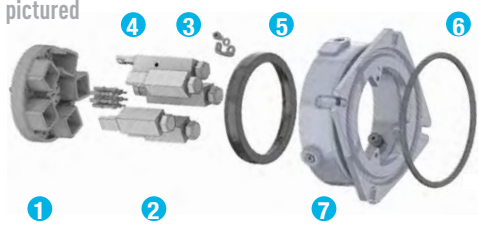

PF pictured



	PFQ300 METAL	PF300 METAL	PF400 METAL	PF600 METAL
1 Plug Interior*	47-3A010 ⁺	49-3A010	49-4A010	49-6A010
Plug Interior with contacts** (Pilot & Ground only)	47-3A110	49-3A110	49-4A110	49-6A110
2 Phase Contact	47-4A011	49-3A011	49-4A011	49-6A011
3 Neutral Contact	47-3A011N	49-3A011N	49-4A011N	49-6A011N
4 Ground Contact	47-3A019	49-3A019	49-4A019	49-6A019
5 Inside Gasket	CPF403PFQ	CPF403	CPF403	CPF403
6 Outside Gasket	CPF405PFQ	CPF405	CPF405	CPF405
7 Plug Metal Casing*	47-3A014	49-3A014	49-4A014	49-6A014

Female Configuration

PFQ pictured

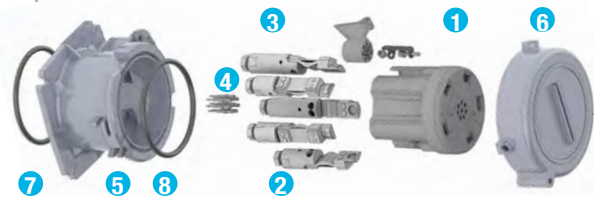

PF pictured

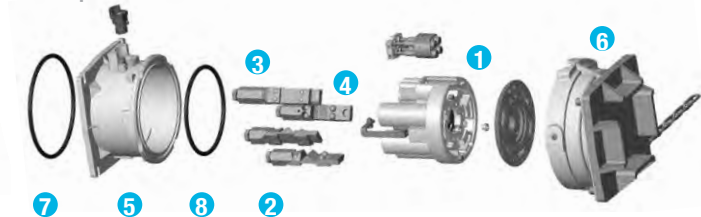

	PFQ300 METAL	PF300 METAL	PF400 METAL	PF600 METAL
1 Receptacle Interior*	47-3A020 ⁺	49-3A020	49-4A020	49-6A020
Receptacles Interior with contacts** (Pilot & Ground only)	47-3A220	49-3A220	49-4A220	49-6A220
2 Phase Contact	47-4A021	49-3A021	49-4A021	49-6A021
3 Neutral Contact	47-3A021N	49-3A021N	49-4A021N	49-6A021N
4 Ground Contact	47-3A029	49-3A029	49-4A029	49-6A029
5 Receptacle Metal Casing*	47-3A024	49-3A024	49-4A024	49-6A024
6 Cap (Receptacle)	47-3A925	49-3A925	49-3A925	49-3A925
7 Inside Gasket	CPF403PFQ	CPF403	CPF403	CPF403
8 Outside Gasket	CPF405PFQ	CPF405	CPF405	CPF405

* Voltage and phasing positions must be specified (5th, 6th & 7th digit of Part #) to duplicate your shutter and alignment notches.

** Includes ground and pilot contacts only.

+ Includes pilot contacts only.

PF/PFQ DIMENSIONS – Provided in inches

Dimensions are for reference only and may change depending on accessories used. For precise dimensions contact MELTRIC Engineering.

angled plug

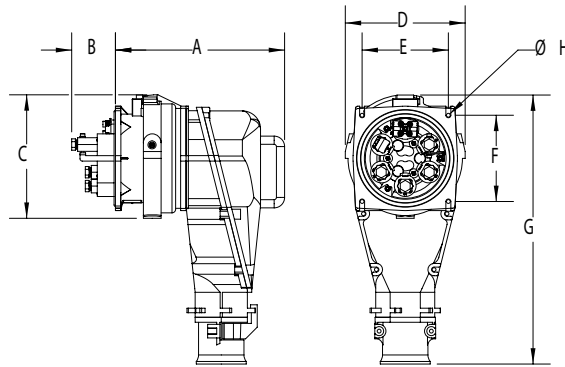

PRODUCT	A	B	C	D	E	F	G	H
PFQ	13.94	2.72	9.61	7.95	5.71	5.71	18.54	0.43
PF	14.67	3.79	10.71	10.39	7.48	7.48	23.33	0.43

straight plug

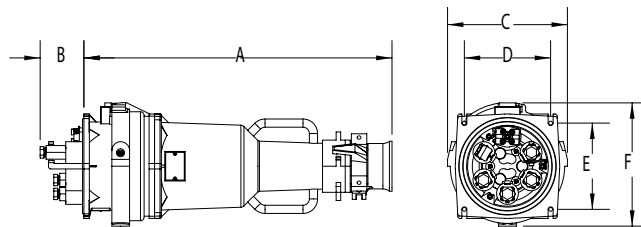

PRODUCT	A	B	C	D	E	F
PFQ	25.4	2.72	7.95	5.71	5.71	9.61
PF	26.72	3.79	10.39	7.48	7.48	10.69

SS Wall Boxes

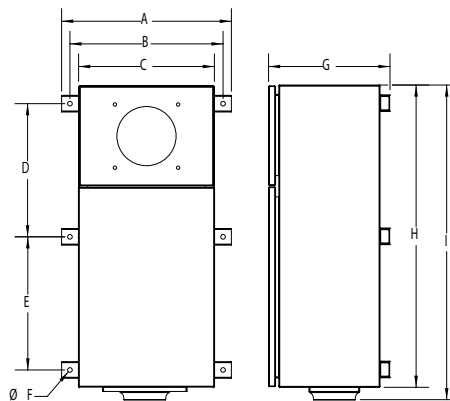

PRODUCT	A	B	C	D	E	F	G	H	I
PFQ	20.08	18.11	16.06	18.03	N/A	0.55	10.55	23.94	25.42
PF	20.08	18.11	16.06	15.75	15.75	0.55	14.36	35.75	37.21

Connector/Plug

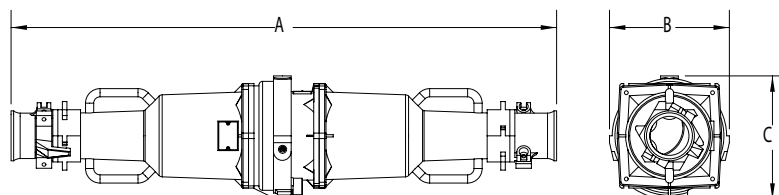

PRODUCT	A	B	C
PFQ	46.5	9.61	7.95
PF	47.31	10.39	10.69



DR400

High Amperage
plug and receptacle



Main Advantages

- ▶ Exclusive contact technology maximizes performance and durability
- ▶ Safety features protect workers
- ▶ Easy plug insertion and removal



Watch the DR400 video
and other product videos
at meltric.com/video

- ▶ Features and Ratings p. 141
- ▶ DR400 p. 142
- ▶ Dimensions p. 143

PRODUCT FEATURES

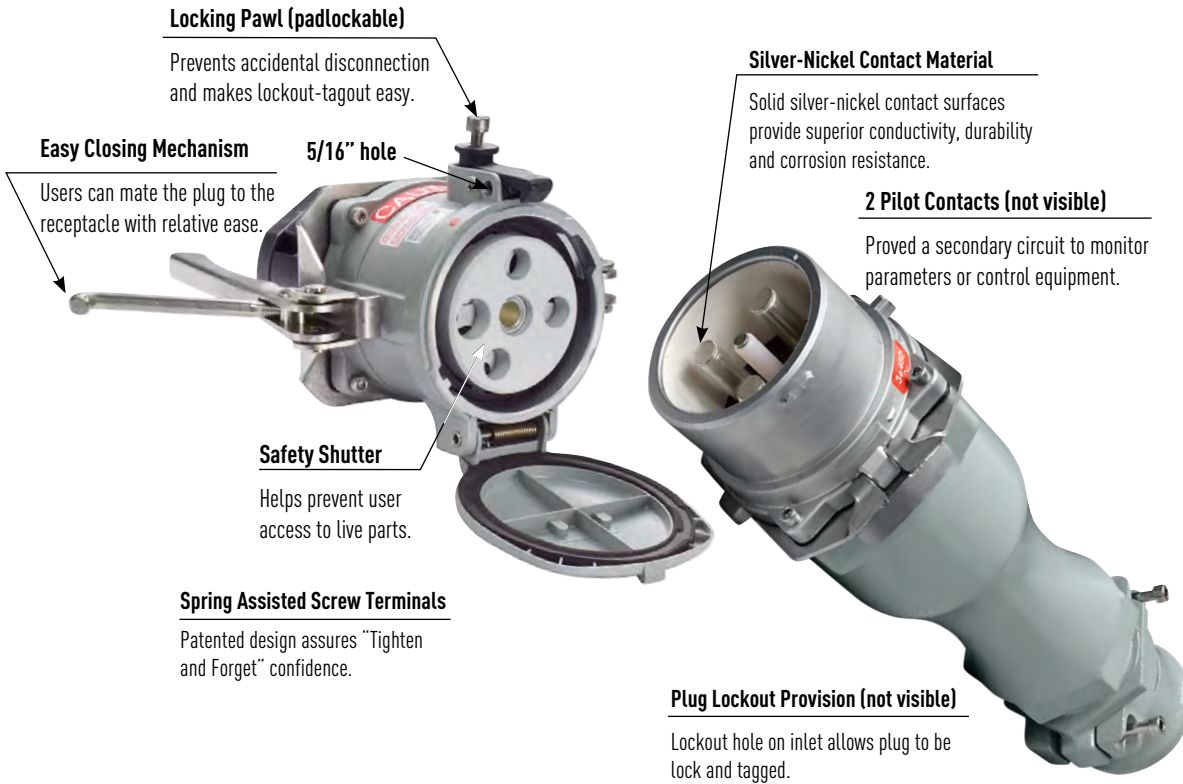

Locking Pawl (padlockable)

Prevents accidental disconnection and makes lockout-tagout easy.

Easy Closing Mechanism

Users can mate the plug to the receptacle with relative ease.

5/16" hole

Safety Shutter

Helps prevent user access to live parts.

Spring Assisted Screw Terminals

Patented design assures "Tighten and Forget" confidence.

Silver-Nickel Contact Material

Solid silver-nickel contact surfaces provide superior conductivity, durability and corrosion resistance.

2 Pilot Contacts (not visible)

Provide a secondary circuit to monitor parameters or control equipment.

Plug Lockout Provision (not visible)

Lockout hole on inlet allows plug to be lock and tagged.

Operating Instructions

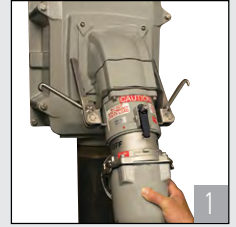

Partially insert the plug.

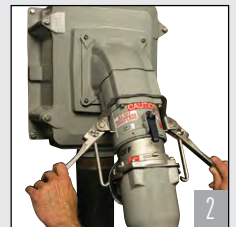

Place the closing mechanism around tabs on inlet.



Push the handles up, the plug is fully drawn into the receptacle.



Use the locking tool and turn clockwise to tighten screw.

General Ratings

Amperage	400A to 480 VAC 350A to 600 VAC
Environmental	IP54 (IP66/IP67 optional)
Temperature	min -40°F/max 140°F

Listings

Category	UL	CSA
Plugs and Receptacles	UL 1682	C22.2 No. 182.1

Highlighted Feature

Silver-Nickel, Spring-Loaded Butt-Style Contacts



Solid Silver-Nickel, Spring-Loaded Butt Style Contacts maintain optimal contact pressure and superior conductivity even in dirty, corrosive environments.

HIGH AMPACITY

DR400 Standard Duty Plugs & Receptacles – 400A

UL/CSA Ratings

- Max Amperage & Voltage**
 400A Max to 480 VAC
 350A Max to 600 VAC
- Current Interruption Capability**
 Not for current interrupting
- Short Circuit Rating**
 18kA
 A withstand test was performed with RK1 current limiting fuses sized at at least 100% of the devices ampacity rating.
- Environmental Ratings**
 IP54/IP55*
 *IP54 when the plug & receptacle are mated. IP55 on the receptacle alone when the lid is latched closed.
- Temperature Range**
 Min -40°F / Max 140°F
- Wiring Capacity**
 Min 2 AWG Max 350 MCM*
 Aux Contacts – 14 AWG (prewired)
 * Wire size to 500 MCM can be accommodated through use of Cable Reducing Adapters. See Accessory Spotlight.
- Certifications**
 UL 1682
 CSA 182.1

Receptacle (female)



Inlet (male)



! Don't forget to add installation accessories to your order

North American UL/CSA Configurations

Voltage	Polarity	Part # Metal	Part # Metal
208V	3P+G+2PIL	39-44163-172	39-48163-172
250V	3P+G+2PIL	39-44073-172	39-48073-172
480V	3P+G+2PIL	39-44043-172	39-48043-172
600V	3P+G+2PIL	39-44143-172	39-48143-172

* 350A only for 600V models
 Other voltage configurations are available - contact customer service at 800.433.7642

For international configurations and ratings (IEC,CE) visit meltric.com/international-catalog or contact customer service at 800.433.7642.

Key Feature

Standard Locking Pawl



DR400 receptacles are provided with a screw-type locking pawl that prevents accidental disconnections under load.

Receptacle Options	Suffix #	Inlet Options	Suffix #
IP66/IP67	Recept # - 4X	IP66/IP67	Inlet # - 4X
Closed Lid Configuration	Recept # - NC	With No Lockout Hole	Inlet # - A155

Order Example: DR400 with Cable Reducing Adapters

To accommodate 500 MCM cable, cable reducing adapters and an extended angle with spacer accessory is required.

Typical order: 480V 3P+G+2PIL



! See pages 248-257 for detailed information on these options

INSTALLATION ACCESSORIES – SIZE 7

Unless indicated otherwise, accessories can be used with either poly or metal plugs and receptacles.

HANDLES

LARGE HANDLE w/NPT	Part #
2"	5T7P0N20
2 1/2"	5T7P0N25
3"	5T7P0N30

LARGE HANDLE w/CORD GRIP Cable Range	Part #
2.062 - 2.188"	5T7P0JT1
2.188 - 2.312"	5T7P0JT2
2.312 - 2.438"	5T7P0JT3
2.437 - 2.625"	5T7P0KT1
2.625 - 2.812"	5T7P0KT2

STRAIGHT HANDLE W/BUSHING w/Cable Range	Part #
2.09 - 2.25"	5T7P0D57
2.25 - 2.44"	5T7P0D62
2.44 - 2.67"	5T7P0D68
2.67 - 2.87"	5T7P0D73

ANGLES

METAL ANGLE	Part #	Description
0°	5T7M0	
Extended 60°	5T7M6	
Extended 60° with 68 mm spacer.	5T7M6-68	Provides space for Cable Reducing Adapters.

BOXES

BOX ANGLE WITH METAL BOX w/NPT	Part #
0° 2"	7T7F0N20
0° 2 1/2"	7T7F0N25
0° 3"	7T7F0N30
0° 3 1/2"	7T7F0N35
0° 4"	7T7F0N40

MISCELLANEOUS ACCESSORIES

PROTECTIVE CAP	Part #	Description
	35-2A126	For Male Devices Only
CABLE REDUCING ADAPTERS		
	PT535FX350-3	Reducer for 500 MCM Fine Stranded or Flexible Wire
	PT500R350-3	Reducer for 500 MCM Coarse Stranded or Building Wire
	PT400R350-3	Reducer for 400 MCM Wire
SPACER		
	5T7M0-68	68mm (2.68») spacer is used (included) with metal 60° angle
	5T7M0-115	115mm can be used when mounting to a panel - though the metal straight adapter is preferred.
PADLOCKABLE PLUG CAP		
	DS2MC	Aluminum - For Male Devices Only.
RECEPTACLE LOCKING PIN		
	LP-843	Requires Padlockable Pawl option (-843) on receptacle.

DIMENSIONS – Provided in inches

Dimensions are for reference only and may change depending on accessories used. For precise dimensions contact MELTRIC Engineering.

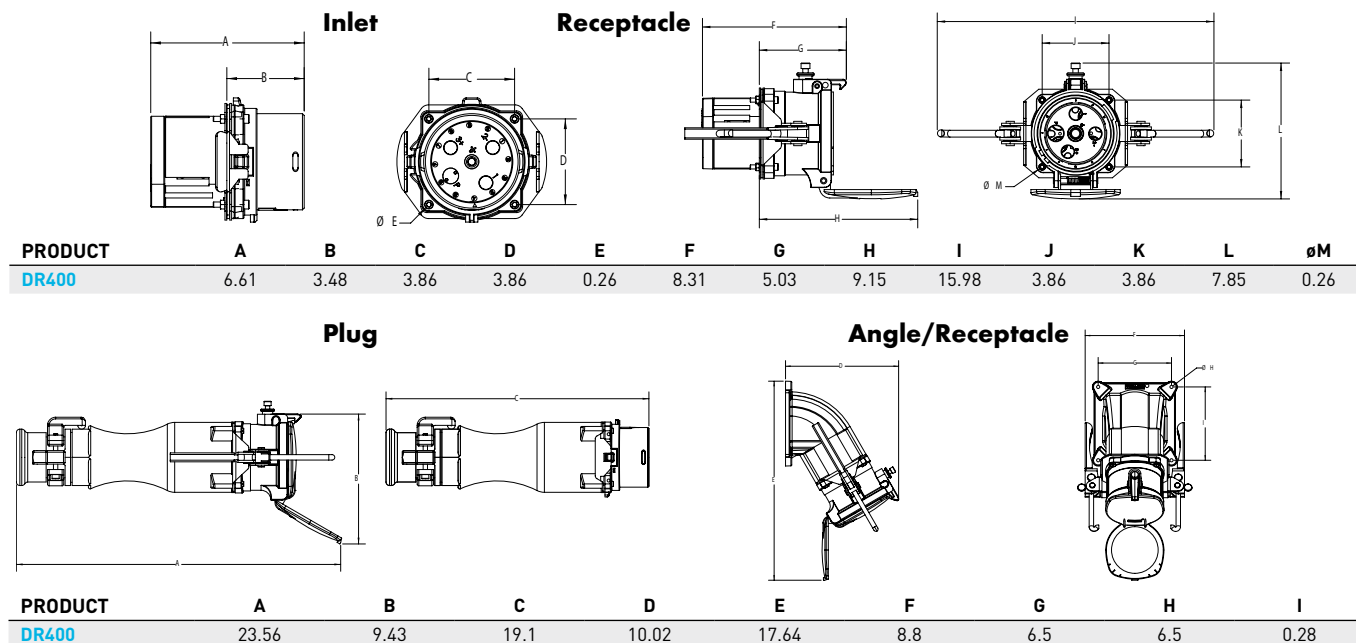

SP High Amperage plug and receptacle



Main Advantages

- ▶ Safety features provide maximum protection
- ▶ Silver, butt-style contact technology maximizes durability
- ▶ IP66/IP67 environmental protection when mated
- ▶ Mechanical coding prevents intermating of phases.



- ▶ **Features and Ratings** p. 145
- ▶ **SP** p. 146
- ▶ **Dimensions** p. 147

PRODUCT FEATURES

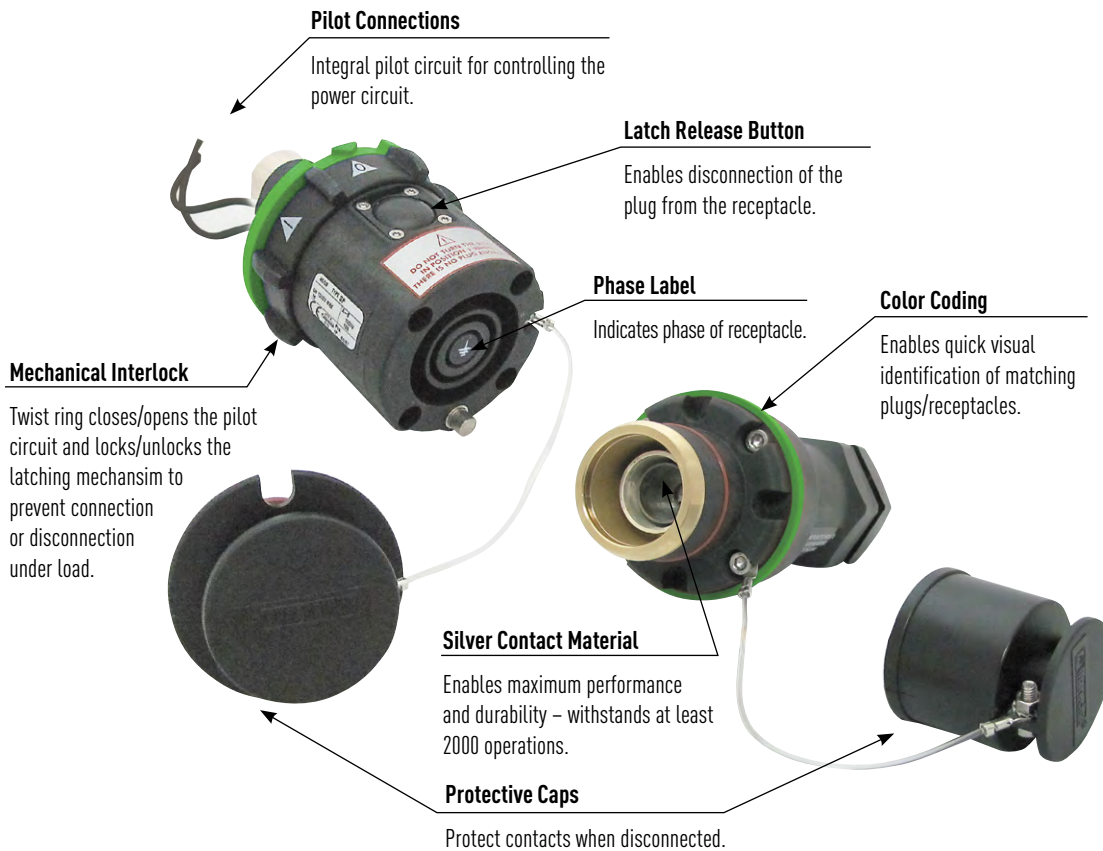

Operating Instructions



To connect, insert the plug into the receptacle until a click is heard. Rotation of the plug in either direction engages a locking finger, which prevents further rotation.



To close the pilot circuit and mechanically lock the plug into the receptacle, turn the ring on the receptacle until the "1" lines up with the arrow. This turns the power on.



To disconnect, open the pilot circuit and unlock the plug by turning the ring until the "0" is aligned with the arrow. The power is now off.



Press firmly on the latch release button and simultaneously pull on the inlet. A slight rotation of the plug may also be required.

HIGH AMPACITY

General Ratings

Listing	CSA	IEC
Amperage	600A	700A
Voltage	600 VAC	1000 VAC / 1500 VDC Max
Frequency	50-400 Hz	50-400 Hz
Horsepower	500 hp	-
Environmental	IP66/IP67	IP66/IP67
Temperature	min -15°F/max 140°F	min -15°F/max 140°F

Highlighted Feature

Pilot Circuit



SP plugs and connectors are designed with safety and durability in mind. Each device is mechanically interlocked with an integral pilot circuit switch for controlling the power circuit in order to prevent connection and disconnection under load.

A typical pilot circuit wiring diagram

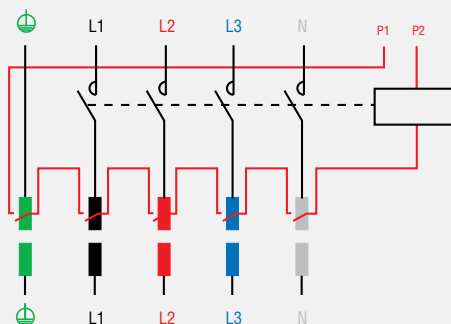

SP Single Pole Plugs & Receptacles – 600A

CSA Ratings

- Max Amperage & Voltage**
 600A, 600 VAC
 Contact customer service to order devices for international applications and for IEC listings up to 700A, 1000 VAC/1500 VDC.
- Current Interruption Capability**
 Non-Load break
- Horsepower Ratings**

480V	3Ø	500 hp
600V	3Ø	500 hp

 CSA HP rated when auxiliary pilots are wired to control motor control circuit.
- Environmental Ratings**
 IP66/IP67
- Temperature Range**
 Min -15°F/Max 140°F
- Wiring Capacity**
 Min 2/0 Max 777 MCM
 Aux Contacts 12-14 AWG
- Applicable Standards**
 CSA 182.1
- Pilot Contact Amperage**
 1A, 240 VAC

Receptacle (female) without lug Inlet (male) without lug



! Don't forget to add installation accessories to your order

North American Configurations

North American Color Code	Polarity	Part # without lug	Part # without lug
	L1	45-44001-P80	45-48001-P80
	L2	45-44002-P80	45-48002-P80
	L3	45-44003-P80	45-48003-P80
	NEUTRAL	45-4400N-P80	45-4800N-P80
	GROUND	45-4400T-P80	45-4800T-P80
	POSITIVE	45-4400P	45-4800P
	NEGATIVE	45-4400M	45-4800M
	GROUND	45-4400T	45-4800T

Notes:

- Not CSA listed. CE rated up to 700A, 1000 VAC/1500 DC.
- Pilot contacts are AC/DC rated for 6A and 250V.

IEC/CE Configurations

CSA Ratings

- Amperage**
 700A
- Voltage**
 1000 VAC, 1500 VDC
- Environmental Ratings**
 IP66/IP67
- Temperature Range**
 Min -40°C/Max 60°C
- Wiring Capacity**
 50 - 400 mm²
- Applicable Standards**
 CE

European Color Code	Polarity	Part # Poly	Part # Poly
	L1	45-44001	45-48001
	L2	45-44002	45-48002
	L3	45-44003	45-48003
	NEUTRAL	45-4400N	45-4800N
	GROUND	45-4400T	45-4800T
	POSITIVE	45-4400P	45-4800P
	NEGATIVE	45-4400M	45-4800M

Notes:

- Not CSA listed. CE rated up to 700A, 1000 VAC/1500 DC.
- Pilot contacts are AC/DC rated for 6A and 250V.

INSTALLATION ACCESSORIES – SIZE S

HANDLES

HANDLE	Cable Outside Diameter	Part #
	.750 - .875	45-4A753-A
	.875 - 1.000	45-4A753-B
	1.000 - 1.125	45-4A753-C
	1.125 - 1.250	45-4A753-D
	1.250 - 1.375	45-4A753-E
	1.250 - 1.375	45-4A783-A
	1.312 - 1.437	45-4A783-B
	1.438 - 1.562	45-4A783-C
	1.562 - 1.688	45-4A783-D

CRIMPING LUGS

CRIMPING LUG – Straight w/terminal	Flexible MCM+ Wire Size	Part #
 (Bolt Included)	1	45-4A50C
	2/0	45-4A70C
	3/0	45-4A95C
	250	45-4A12C
	300	45-4A15C
	350	45-4A18C
	450	45-4A24C
	600	45-4A30C
777	45-4A40C	

ANGLES

METAL ANGLE	Part #
 45°	45-4A027

CRIMPING LUG – Straight Threaded**	Flexible MCM+ Wire Size	Part #
	1	45-4A50D
	2/0	45-4A70D
	3/0	45-4A95D
	250	45-4A12D
	300	45-4A15D
	350	45-4A18D
	450	45-4A24D
	600	45-4A30D
777	45-4A40D	

+ Based on flexible type copper cables. See appropriate NEC tables for applicable ampacities
 ** Conductor sizes are approximations based on metric wire size conversions.
 * Use the straight threaded lug when cord mounting with handle accessory.

Dimensions Inlet/Receptacle – Provided in inches

Dimensions are for reference only and may change depending on accessories used. For precise dimensions contact MELTRIC Engineering.

inlet

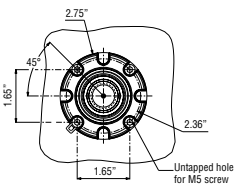

receptacle

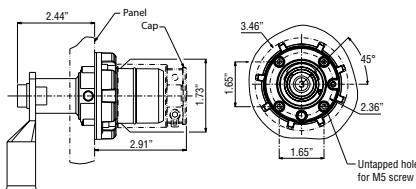

plug

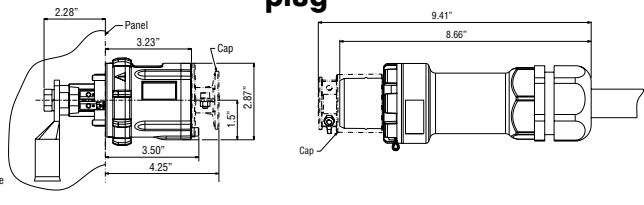

connector

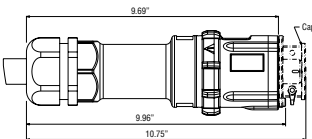

plug/connector

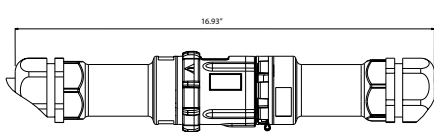

plug with connector on/off

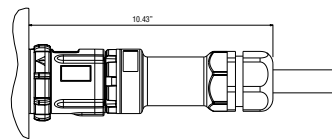

connector with plug on/off

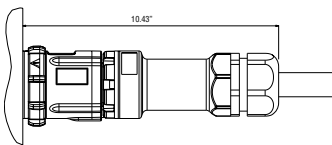

45° inclined receptacle/angle with plug

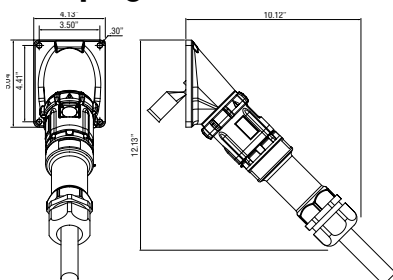

45° inclined inlet/angle with connector

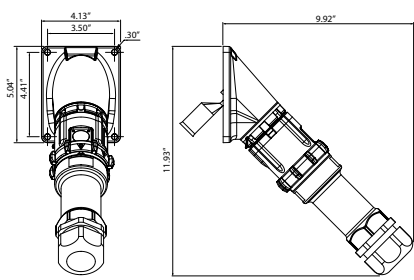

CS1000

High Amperage
plug and receptacle



Main Advantages

- ▶ High Amperage Capacity up to 400A at 600VAC, 600VDC (in North America) or 1000VAC, 1500VDC (in Europe - CE rated).
- ▶ Safety features protect users from live parts and prevent unwanted disconnection.
- ▶ Silver-nickel butt contacts provide superior performance and corrosion resistance.

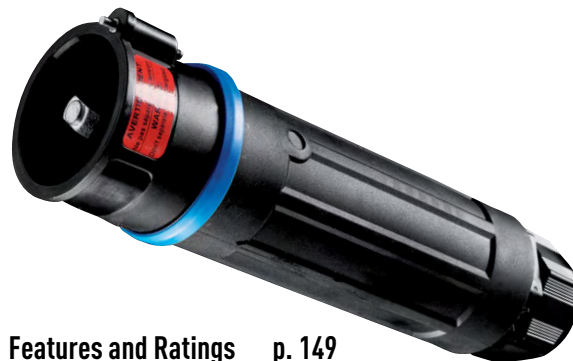

- ▶ Features and Ratings p. 149
- ▶ CS1000 p. 150
- ▶ Dimensions p. 151

PRODUCT FEATURES

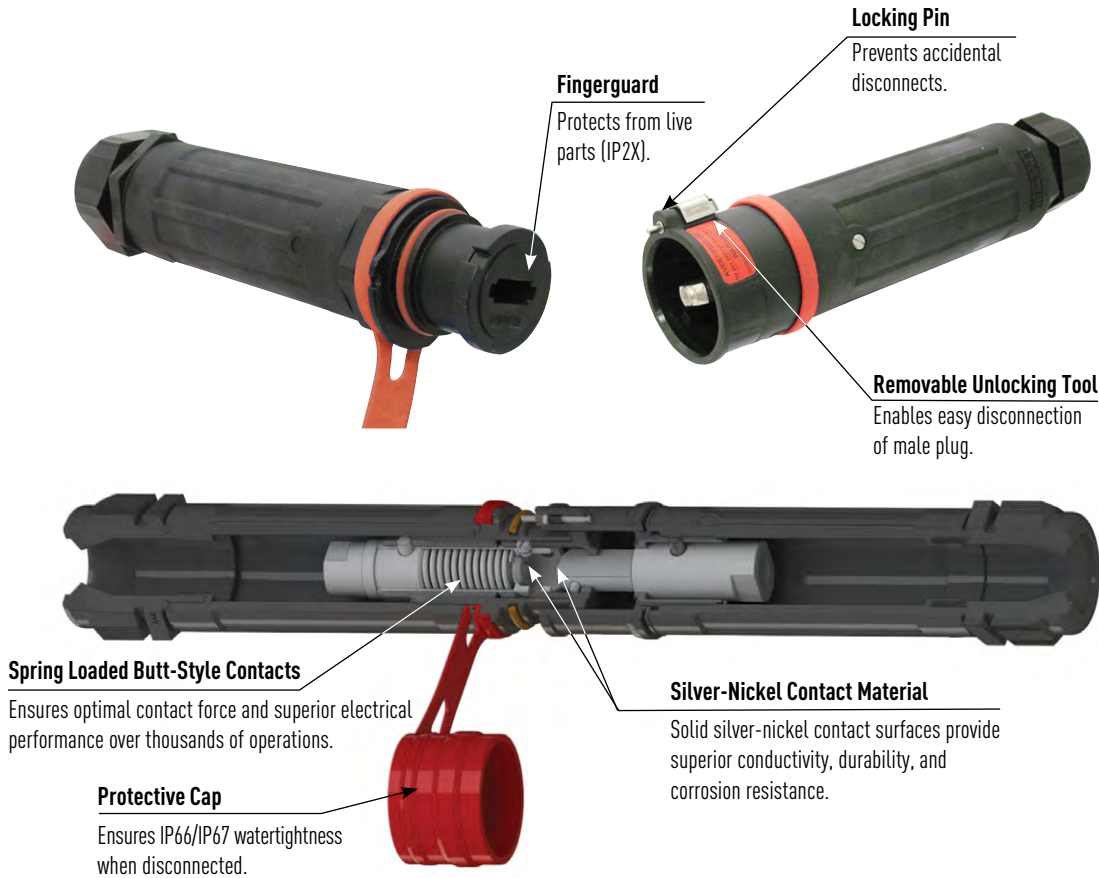

Operating Instructions

Connection



Disconnection



General Ratings

Amperage	400A
Voltage	1000 VAC, 1500 VDC
Frequency	50-400 Hz
Environmental	IP66/IP67
Temperature	min -40°F/max 140°F

* CS1000 plugs and receptacles are UL listed in accordance with UL 1691. CS1000 devices are for use in non-load break applications up to 400A at 600VAC, 600VDC (in North America) or 1000VAC, 1500VDC (in Europe - CE rated).

Listings

Category	UL	CSA	IEC
Receptacles for Plugs and Attachment Plugs	UL 1691	CSA 1691-12	60309-1

Highlighted Feature

5 Mechanical Keying Postions (North America color codes shown.)



CS1000 Standard Duty Plugs & Receptacles

400A-1000 VAC

Receptacle (female) without lug **Inlet** (male) without lug



! Don't forget to add installation accessories to your order

UL/CSA Ratings

- Amperage**
400A
Not for Current Interrupting
- Voltage**
600 VAC, 600 VDC
- Short Circuit Rating**
10kA Withstand
Testing was performed with RK1 current limiting fuses sized at at least 100% of the devices ampacity rating.
- Environmental Ratings**
IP66/IP67
- Temperature Range**
Min -40°F / Max 140°F
- Wiring Capacity**
Min 1/0 AWG / Max 450 MCM
90°C rated wire must be used
- Applicable Standards**
UL 1691
CSA 1691-12

North American Configurations

North American Color Code	Polarity	Part # without lug	Part # without lug
	L1	45-34001-P80	45-38001-P80
	L2	45-34002-P80	45-38002-P80
	L3	45-34003-P80	45-38003-P80
	NEUTRAL	45-3400N-P80	45-3800N-P80
	GROUND	45-3400T-P80	45-3800T-P80
	POSITIVE	45-3400P-P80	45-3800P-P80
	NEGATIVE	45-3400M-P80	45-3800M-P80

IEC/CE Configurations

European Color Code	Polarity	Part # Poly	Part # Poly
	L1	45-34001	45-38001
	L2	45-34002	45-38002
	L3	45-34003	45-38003
	NEUTRAL	45-3400N	45-3800N
	GROUND	45-3400T	45-3800T
	POSITIVE	45-3400P	45-3800P
	NEGATIVE	45-3400M	45-3800M

IEC/CE Ratings

- Amperage**
400A
Not for Current Interrupting
- Voltage**
1000 VAC, 1500 VDC
- Environmental Ratings**
IP66/IP67
- Temperature Range**
Min -40°F / Max 140°F
- Wiring Capacity**
Min 1/0 AWG / Max 450 MCM
- Applicable Standards**
CE

INSTALLATION ACCESSORIES – SIZE M

ANGLES



POLY ANGLE	
	0° 45-3A540 Required for mounting on panels, walls, etc.
	30° 45-3A027 With Adapter Plate

ACCESSORIES



	INLET CAP 45-3A126
	UNLOCKING TOOL 45-3A396 One unlocking tool on a "valet" style separable key ring is included with each male inlet.
	PADLOCKING TOOL 45-3A843

INSTALLATION ACCESSORIES – SIZE M

HANDLES

HANDLE	Cable Outside Diameter	Part #	
	.550 - 1.000	45-3A753	Normal Duty 100 lb grip
	.700 - 1.260	45-3A783	
HANDLE w/Cord Grip (Mesh) Cable			
	Outside Diameter		
	.500 - .625	45-3A753-A	Heavy Duty 300 lb grip
	.562 - .688	45-3A753-B	
	.625 - .750	45-3A753-C	
	.688 - .812	45-3A753-D	
	.750 - .875	45-3A753-E	
	.875 - 1.000	45-3A783-A	
	1.000 - 1.125	45-3A783-B	
	1.125 - 1.250	45-3A783-C	
	1.250 - 1.375	45-3A783-D	

CRIMPING LUGS

STRAIGHT w/TERMINAL	Conductor Size	Allowable Current (A)	Internal Diameter (in)	Part #
	1/0 ²	200	.43	45-4A50C
	2/0	250	.52	45-4A70C
	3/0	275		
	4/0	300	.58	45-4A95C
	250	325	.63	45-4A12C
	350	350	.80	45-4A18C
	450	400	.90	45-4A24C
	Use with angle 30° or direct mount			
STRAIGHT THREADED	Conductor Size	Allowable Current (A)	Internal Diameter (in)	Part #
	1/0 ²	200	.43	45-4A50D
	2/0	250	.52	45-4A70D
	3/0	275		
	4/0	300	.58	45-4A95D
	250	325	.63	45-4A12D
	350	350	.80	45-4A18D
	450	400	.90	45-4A24D

- 1 Lugs to be crimped with Greenlee EK6/DL11 Crimping Tool Dieless 120V CHR.G.
- 2 The ground conductor for the CS1000 series devices shall be limited to a maximum size of 1/0 AWG.

Dimensions Inlet/Receptacle – Provided in inches

Dimensions are for reference only and may change depending on accessories used. For precise dimensions contact MELTRIC Engineering.

receptacle

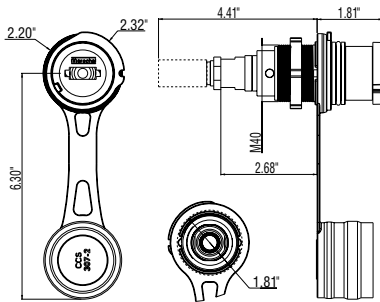

plug/receptacle

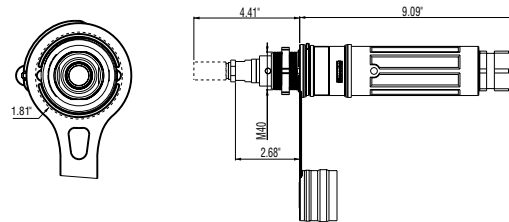

inline connector

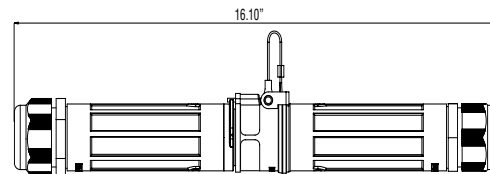

30° inclined receptacle / angle

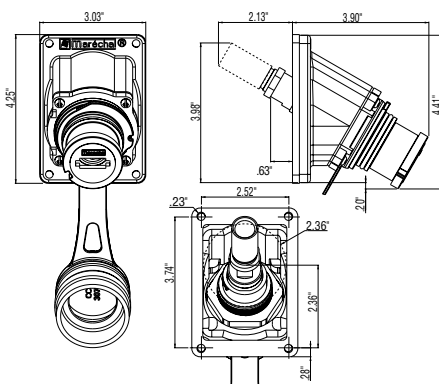

30° receptacle / angle with plug

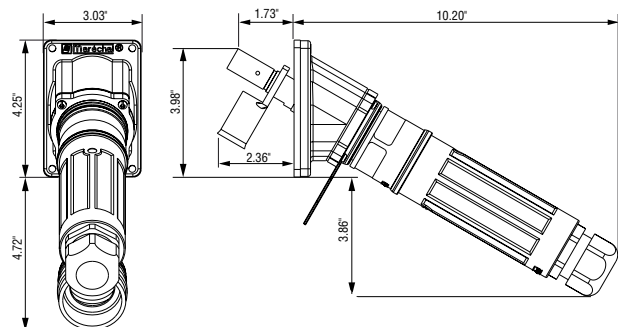

POWER DISTRIBUTION



MELTRIC manufactures a wide variety of specialty products to fit specific application needs and to help users benefit from the advantages of MELTRIC's Switch-Rated plugs and receptacles where ever connections may need to be made and broken.

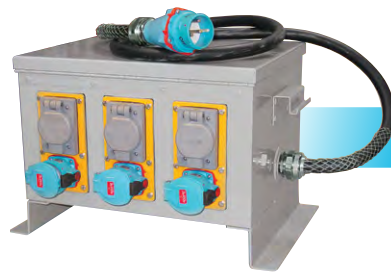

CUSTOM P. 154

WIDE VARIETY OF PLATFORMS AND FEATURES

- Custom engineered
- Featuring Switch-Rated plugs & receptacles



RUBBER BOX P. 156

PORTABLE RUBBER BOX PLATFORM

- Standard or custom configurations
- One, two, or three tier rubber boxes
- Featuring Switch-Rated plugs & receptacles

CUSTOM

Power Distribution



Custom power solutions from MELTRIC provide the switch-rated safety and durability of MELTRIC Switch-Rated plugs and receptacles in a power distribution package built specifically to customer needs. Whether you require power distribution in a vertical stand configuration, a low profile horizontal configuration, a custom configuration, or as a cordset; MELTRIC's engineering team can build a package to meet your needs.



Available Features

- ▶ GFCI Protection
- ▶ Color-coded Enclosures
- ▶ Phase Indication
- ▶ Stainless Steel Enclosures
- ▶ 120V Convenience Outlet
- ▶ Rain Hoods
- ▶ Timers
- ▶ Pilot Circuits
- ▶ Wheel Kits
- ▶ Shunt Trips
- ▶ Under Voltage Trips
- ▶ Lifting Provisions
- ▶ Power Transformers

COMMON PLATFORMS



Power/Transformer Assembly



Vertical Power

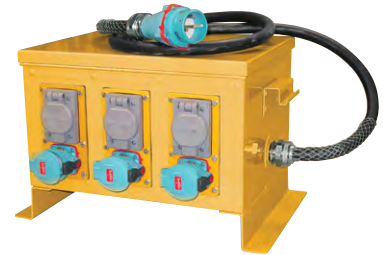

Horizontal Multigang



SB Enclosures



Rubber Box



Portable Panel Assembly



Wall Mounted Panel Assembly



Cable Assembly

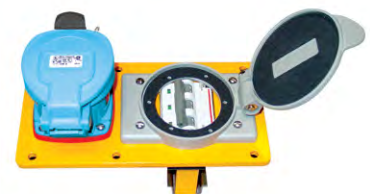

Breaker Plate Assembly

Rubber Boxes Power Distribution

UL Type 3R Enclosures



1 Tier

3 Tier

2 Tier

Choose from standard configurations on pages 157-159 or contact MELTRIC at 800.433.7642 for customized configurations.

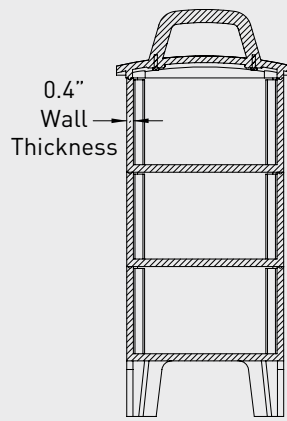
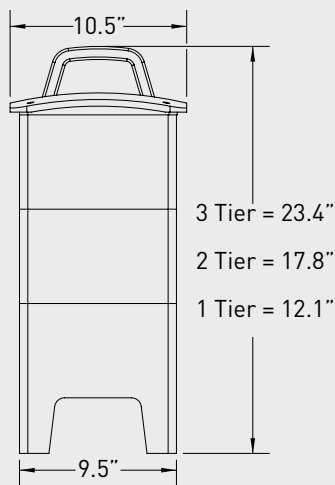

Cross-Section of Enclosure

Power Input up to 100A, 480 VAC.
Choose a mounted inlet or a cord & plug.



Mounted Inlet



Cord & Plug

Power Receptacles



Room for (2) DSN60 (or smaller) receptacles per side per tier.

Circuit Protection



Room for up to (10) poles of standard MCB's (mini circuit breakers) per tier.

Convenience Outlets



Room for (2) Type 5-20R duplex receptacles per side per tier or choose other convenience outlets.

1 TIER RUBBER POWER DISTRIBUTION BOXES

Configuration T1-C1

Notes: Two receptacles share a 3P breaker.



Side 1

(2) DSN Receptacles



Side 2

(2) 3 Pole MCB's



Side 3

(2) DSN Receptacles



Side 4

(1) Inlet

Voltage		Contacts	Part #: Configuration T1-C1-20A 20A DSN Recepts & 30A DSN Inlet	Part #: Configuration T1-C1-30A 30A DSN Recepts & 60A DSN Inlet	Part #: Configuration T1-C1-60A 60A DSN Recepts & 100A DSC100C Inlet
120	208V	3P+N+G	RBT1-C1-167-20A	RBT1-C1-167-30A	RBT1-C1-167-60A
125	250V	3P+N+G	RBT1-C1-077-20A	RBT1-C1-077-30A	RBT1-C1-077-60A
480V		3P+G	RBT1-C1-043-20A	RBT1-C1-043-30A	RBT1-C1-043-60A

Configuration T1-C2



Side 1

(1) DSN Receptacles
(1) 20A Type 5-20 Duplex GFCI



Side 2

(2) 3 Pole MCB's
(2) 20A 1 Pole MCB's



Side 3

(1) DSN Receptacles
(1) 20A Type 5-20 Duplex GFCI



Side 4

(1) Inlet

Voltage		Contacts	Part #: Configuration T1-C2-20A 20A DSN Recepts & 30A DSN Inlet	Part #: Configuration T1-C2-30A 30A DSN Recepts & 60A DSN Inlet	Part #: Configuration T1-C2-60A 60A DSN Recepts & 100A DSC100C Inlet
120	208V	3P+N+G	RBT1-C2-167-20A	RBT1-C2-167-30A	RBT1-C2-167-60A
125	250V	3P+N+G	RBT1-C2-077-20A	RBT1-C2-077-30A	RBT1-C2-077-60A

Configuration T1-C3



Side 1

(1) DSN 30A Receptacle
(1) DSN 20A Receptacle



Side 2

(2) 30A 3 Pole MCB
(2) 20A 3 Pole MCB



Side 3

(1) DSN 30A Receptacle
(1) DSN 20A Receptacle



Side 4

(1) DSN 60A Inlet

Voltage		Contacts	Part #: Configuration T1-C3 20/30A DSN Recepts & 60A DSN Inlet
120	208V	3P+N+G	RBT1-C3-167
125	250V	3P+N+G	RBT1-C3-077A
480V		3P+G	RBT1-C3-043

Notes: 30A receptacles are protected by individual 30A breakers. 20A receptacles share a 20A breaker.

* Ampacity ratings of MCB's match the receptacles they protect.

2 TIER RUBBER POWER DISTRIBUTION BOXES

Configuration T2-C1

Notes: Two receptacles share a 3P breaker.



Side 1

- (1) DSN 30A Receptacle
- (1) DSN 20A Receptacle
- (1) DSN 60A Receptacle



Side 2

- (2) 30A 3 Pole MCB's
- (2) 20A 3 Pole MCB's
- (2) 60A 3 Pole MCB's
- (2) 20A 1 Pole MCB's



Side 3

- (1) DSN 30A Receptacle
- (1) DSN 20A Receptacle
- (1) DSN 60A Receptacle



Side 4

- (2) 20A Type 5-20 Duplex GFCI
- (1) DS100C 100A Inlet

Voltage		Contacts	Part #: Configuration T2-C1 20/30/60A DSN Recepts & 100A DS100C Inlet
120	208V	3P+N+G	RBT2-C1-167
125	250V	3P+N+G	RBT2-C1-077

Configuration T2-C2



Side 1

- (4) DSN Receptacles



Side 2

- (4) 3 Pole MCB's
- (2) 20A 1 Pole MCB's



Side 3

- (4) DSN Receptacles



Side 4

- (2) 20A Type 5-20 Duplex GFCI
- (1) DS100C 100A Inlet

Voltage	Contacts	Part #: Configuration T2-C2-20A 20A DSN Recepts & 100A DS100C Inlet	Part #: Configuration T2-C2-30A 30A DSN Recepts & 100A DS100C Inlet
		120	208V
125	250V	RBT2-C2-077-20A	RBT2-C2-077-30A

* Ampacity ratings of MCB's match the receptacles they protect.

3 TIER RUBBER POWER DISTRIBUTION BOXES

Configuration T3-C1

Notes: Two receptacles share a 3P breaker.



Side 1

- (1) 20A Type 5-20 Duplex GFCI
- (2) DSN 20A Receptacle
- (2) DSN 30A Receptacle



Side 2

- (6) 20A 1 Pole MCB's
- (4) 20A 3 Pole MCB's
- (4) 30A 3 Pole MCB's



Side 3

- (1) 20A Type 5-20 Duplex GFCI
- (2) DSN 20A Receptacle
- (2) DSN 30A Receptacle



Side 4

- (1) 20A Type 5-20 Duplex GFCI
- (1) DS100C 100A Inlet

Voltage		Contacts	Part #: Configuration T3-C1 20 & 30A DSN Recepts & 100A DS100C Inlet
120	208V	3P+N+G	RBT3-C1-167
125	250V	3P+N+G	RBT3-C1-077

Configuration T3-C2



Side 1

- (1) DSN Receptacles
- (1) 20A Type 5-20 Duplex GFCI



Side 2

- (2) 3 Pole MCB's
- (2) 20A 1 Pole MCB's



Side 3

- (1) DSN Receptacles
- (1) 20A Type 5-20 Duplex GFCI



Side 4

- (1) Inlet

Voltage		Contacts	Part #: Configuration T3-C2-20A 20A & 60A DSN Recepts & 100A DS100C Inlet	Part #: Configuration T3-C2-30A 30A & 60A DSN Recepts & 100A DS100C Inlet
120	208V	3P+N+G	RBT3-C2-167-20A	RBT3-C2-167-30A
125	250V	3P+N+G	RBT3-C2-077-20A	RBT3-C2-077-30A

* Ampacity ratings of MCB's match the receptacles they protect.

CIRCUIT PROTECTED

Receptacles



MELTRIC manufactures a variety of specialty products that allow facilities to benefit from switch-rated receptacles in combination with other devices including circuit protected receptacles, receptacles with GFCI protections, and receptacles mounted on safety switches. Standard and custom configurations can be ordered.



CPR P. 162

LOCAL CIRCUIT PROTECTION

- 20A, 30A, of 60A sizes
- Switch-rated receptacles mounted and wired to circuit protection device
- Fuseholder or mini-circuit breaker options.



GFCI P. 168

GFCI PROTECTION

- 20A, 30A, of 60A sizes All industries
- DSN receptacles mounted and wired to GFCI
- Detects AC and DC ground faults



SAFETY SWITCHES P. 170

FOR ADDED PROTECTION

- 30A to 100A sizes
- Heavy duty, single throw, fusible safety switch.
- Switch-Rated receptacles mounted and wired to disconnect switch

Receptacles & Wall Boxes

with Integral Circuit Protection



MELTRIC's receptacle/wall box combinations with integral circuit protection combine the safety of a MELTRIC DSN series switch-rated receptacle with the convenience of local circuit protection in a compact package. The receptacle is premounted to the box and wired to the circuit protection device for easy installation.

Models are available with or without a viewing window and in either painted mild steel or stainless steel enclosures. The 20A and 30A models are available and equipped with fuse holders or mini-circuit breakers and the 60A models are available with fuseholders or supplementary protectors.

Fuseholder Equipped Models



MELTRIC's DSN Series switch-rated plugs and receptacles are UL rated to withstand and close-into short circuit currents up to 100kA in circuits protected by RK1 current limiting fuses or other fuses with lower let through energy like Class CC and Class J fuses. This allows users to take advantage of the DSN's capabilities in applications where higher fault currents are not already protected with the required fusing.

Fuseholder models feature Ferraz Shawmut Ultra-Safe Fuse Holders (UL 512 / IEC 269). The fuseholders have a blown fuse indicator light for each pole and pivot open for easy and finger safe fuse replacement. Fuses are not provided. They should be selected for the specific application.

Circuit Breaker Equipped Models



Circuit-breaker equipped models allow users to provide overload protection in a convenient location near the application. The 20A & 30A models feature Eaton WMZT miniature circuit breakers (UL 489) and the 60A models use Eaton WMZS supplementary protectors (UL 1077). All are provided standard with a 'C' trip curve. A 'D' trip curve for the 20A and 30A breakers, and a 'B' trip curve for the 60A supplementary protectors are also available as options.

Trip Curve Characteristics

- "B" Curve: The protective device will instantaneously trip @ 3X to 5X its rated current
- "C" Curve: The protective device will instantaneously trip @ 5X to 10X its rated current
- "D" Curve: The protective device will instantaneously trip @ 10X to 20X its rated current

Enclosures

The wall boxes are Hoffman Inline® series enclosures.

- Dimensions:** **20A/30A Fuse Holder/Circuit Breaker**
Box exteriors = 9.84" x 7.87" x 5.91" (250mm x 200mm x 150mm).
Mounting footprint = 12.5" x 8" including the pre-installed mounting brackets.
- 60A Supplementary Circuit Breaker**
Box exteriors = 9.84" x 7.87" x 5.91" (250mm x 200mm x 150mm).
Mounting footprint = 12.5" x 8" including the pre-installed mounting brackets.
- 60A Fuse Holder**
Box exteriors = 11.81" x 9.84" x 5.91" (300mm x 250mm x 150mm).
Mounting footprint = 14.4" x 9.8" including the pre-installed mounting brackets.
- Box Materials:** Mild steel boxes are 16 gauge, stainless steel boxes are 14 gauge type 304.
Available door windows are 3/16" clear polycarbonate.
- Latch:** Quarter turn slotted stainless steel design for easy operation and durability.
- Finish:** Mild steel boxes are painted with a light gray textured polyester powdercoat.
Stainless Steel boxes have a #4 brushed finish.
- Environmental:** Mild steel boxes are NEMA Type 4 and 12 .
Stainless steel boxes are NEMA Type 4, 4X and 12.



MILD STEEL BOXES with Ultra-Safe Fuse Holders

UL/CSA Ratings

- Voltage**
 20A: 600 VAC
 30A: 600 VAC
 60A: 600 VAC
- Environmental Ratings**
 Overall: NEMA Type 4
 Box: NEMA Type 4, 12
 Receptacle: NEMA Type 4X
- Temperature Range**
 Min -40°F / Max 140°F
- Listings**
 Box: UL 508A

 Receptacle: UL 2682,
 UL 1682, CSA 22.2 No. 182.1,
 IEC 60309-1

 Fuseholder: UL 512, IEC 269

Standard Box



Box with Viewing Window



North American UL/CSA Configurations

Voltage	Polarity	Part #			Part #		
		20A	30A	60A	20A	30A	60A
120V	1P+N+G	FB-63-14165	FB-63-34165	FB-63-64165	FBW-63-14165	FBW-63-34165	FBW-63-64165
120 208V	3P+N+G	FB-63-14167	FB-63-34167	FB-63-64167	FBW-63-14167	FBW-63-34167	FBW-63-64167
125V	1P+N+G	FB-63-14075	FB-63-34075	FB-63-64075	FBW-63-14075	FBW-63-34075	FBW-63-64075
125 250V	2P+N+G	FB-63-14076	FB-63-34076	FB-63-64076	FBW-63-14076	FBW-63-34076	FBW-63-64076
208V	2P+G	FB-63-14162	FB-63-34162	FB-63-64162	FBW-63-14162	FBW-63-34162	FBW-63-64162
208V	3P+G	FB-63-14163	FB-63-34163	FB-63-64163	FBW-63-14163	FBW-63-34163	FBW-63-64163
250V	2P+G	FB-63-14072	FB-63-34072	FB-63-64072	FBW-63-14072	FBW-63-34072	FBW-63-64072
250V	3P+G	FB-63-14073	FB-63-34073	FB-63-64073	FBW-63-14073	FBW-63-34073	FBW-63-64073
277V	1P+N+G	FB-63-14045	FB-63-34045	FB-63-64045	FBW-63-14045	FBW-63-34045	FBW-63-64045
277 480V	3P+N+G	FB-63-14047	FB-63-34047	FB-63-64047	FBW-63-14047	FBW-63-34047	FBW-63-64047
347 600V	3P+N+G	FB-63-14147	FB-63-34147	FB-63-64147	FBW-63-14147	FBW-63-34147	FBW-63-64147
480V	2P+G	FB-63-14042	FB-63-34042	FB-63-64042	FBW-63-14042	FBW-63-34042	FBW-63-64042
480V	3P+G	FB-63-14043	FB-63-34043	FB-63-64043	FBW-63-14043	FBW-63-34043	FBW-63-64043
600V	2P+G	FB-63-14142	FB-63-34142	FB-63-64142	FBW-63-14142	FBW-63-34142	FBW-63-64142
600V	3P+G	FB-63-14143	FB-63-34143	FB-63-64143	FBW-63-14143	FBW-63-34143	FBW-63-64143

For international configurations and ratings (IEC, CE) visit meltric.com/international-catalog or contact customer service at 800.433.7642.

Main Options



Auxiliary/Pilot Contacts



Mushroom Pawl



Padlock Pawl



Closed Lid Configuration

Recommended for cord applications to keep lid tucked in to avoid damage.

Receptacle Options

Suffix

- With 2 Auxiliary/Pilot Contacts **Recept # - 972**
- Mushroom Pawl **Recept # - 375**
- Padlock Pawl **Recept # - 843**
- Closed Lid Configuration **Recept # - NC**



Ferraz Shawmut 30A, 600V Ultra-Safe Fuse Holders for Class CC fuses are standard. They include a blown fuse indicator for each pole. Fuses are not included.

! See pages 248-257 for detailed information on these options

SS BOXES with Ultra-Safe Fuse Holders

Standard Box



Box with Viewing Window



North American UL/CSA Configurations

Voltage	Polarity	Part #			Part #		
		20A	30A	60A	20A	30A	60A
120V	1P+N+G	FBSS-63-14165	FBSS-63-34165	FBSS-63-64165	FBWSS-63-14165	FBWSS-63-34165	FBWSS-63-64165
120 208	3P+N+G	FBSS-63-14167	FBSS-63-34167	FBSS-63-64167	FBWSS-63-14167	FBWSS-63-34167	FBWSS-63-64167
125V	1P+N+G	FBSS-63-14075	FBSS-63-34075	FBSS-63-64075	FBWSS-63-14075	FBWSS-63-34075	FBWSS-63-64075
125 250	2P+N+G	FBSS-63-14076	FBSS-63-34076	FBSS-63-64076	FBWSS-63-14076	FBWSS-63-34076	FBWSS-63-64076
208V	2P+G	FBSS-63-14162	FBSS-63-34162	FBSS-63-64162	FBWSS-63-14162	FBWSS-63-34162	FBWSS-63-64162
208V	3P+G	FBSS-63-14163	FBSS-63-34163	FBSS-63-64163	FBWSS-63-14163	FBWSS-63-34163	FBWSS-63-64163
250V	2P+G	FBSS-63-14072	FBSS-63-34072	FBSS-63-64072	FBWSS-63-14072	FBWSS-63-34072	FBWSS-63-64072
250V	3P+G	FBSS-63-14073	FBSS-63-34073	FBSS-63-64073	FBWSS-63-14073	FBWSS-63-34073	FBWSS-63-64073
277V	1P+N+G	FBSS-63-14045	FBSS-63-34045	FBSS-63-64045	FBWSS-63-14045	FBWSS-63-34045	FBWSS-63-64045
277 480	3P+N+G	FBSS-63-14047	FBSS-63-34047	FBSS-63-64047	FBWSS-63-14047	FBWSS-63-34047	FBWSS-63-64047
347 600	3P+N+G	FBSS-63-14147	FBSS-63-34147	FBSS-63-64147	FBWSS-63-14147	FBWSS-63-34147	FBWSS-63-64147
480V	2P+G	FBSS-63-14042	FBSS-63-34042	FBSS-63-64042	FBWSS-63-14042	FBWSS-63-34042	FBWSS-63-64042
480V	3P+G	FBSS-63-14043	FBSS-63-34043	FBSS-63-64043	FBWSS-63-14043	FBWSS-63-34043	FBWSS-63-64043
600V	2P+G	FBSS-63-14142	FBSS-63-34142	FBSS-63-64142	FBWSS-63-14142	FBWSS-63-34142	FBWSS-63-64142
600V	3P+G	FBSS-63-14143	FBSS-63-34143	FBSS-63-64143	FBWSS-63-14143	FBWSS-63-34143	FBWSS-63-64143

For international configurations and ratings (IEC,CE) visit meltric.com/international-catalog or contact customer service at 800.433.7642.

UL/CSA Ratings

- **Voltage**
20A: 600 VAC
30A: 600 VAC
60A: 600 VAC
- **Environmental Ratings**
Overall: NEMA Type 4X
Box: NEMA Type 4X, 12
Receptacle: NEMA Type 4X
- **Temperature Range**
Min -40°F/Max 140°F
- **Listings**
Box: UL 508A
Receptacle: UL 2682, UL 1682, CSA 22.2 No. 182.1, IEC 60309-1
Fuseholder: UL 512, IEC 269

Receptacle Options

Suffix

With 2 Auxiliary/Pilot Contacts	Recept # - 972
Mushroom Pawl	Recept # - 375
Padlock Pawl	Recept # - 843
Closed Lid Configuration	Recept # - NC



Ferraz Shawmut 30A, 600V Ultra-Safe Fuse Holders for Class CC fuses are standard. They include a blown fuse indicator for each pole. Fuses are not included.

Main Options



**Auxiliary/Pilot
Contacts**



**Mushroom
Pawl**



Padlock Pawl



**Closed Lid
Configuration**

Recommended for cord applications to keep lid tucked in to avoid damage.

! See pages 248-257 for detailed information on these options

MILD STEEL BOXES with Circuit Breakers

UL/CSA Ratings

- Voltage**
 20A: 480 VAC
 30A: 480 VAC
 60A: 480 VAC
- Environmental Ratings**
 Overall: NEMA Type 4
 Box: NEMA Type 4, 12
 Receptacle: NEMA Type 4X
- Temperature Range**
 Min -40°F/Max 140°F for 20A & 30A
 Min 23°F/Max 104°F for 60A
- Listings**
 Box: UL 508A
 Receptacle: UL 2682,
 UL 1682, CSA 22.2 No. 182.1,
 IEC 60309-1
 Breaker: UL 489 for 20A & 30A,
 UL 1077 for 60A

Standard Box



Box with Viewing Window



! Don't forget to add installation accessories to your order

North American UL/CSA Configurations

Voltage	Polarity	Part #			Part #		
		20A	30A	60A	20A	30A	60A
120V	1P+N+G	CB-63-14165	CB-63-34165	CB-63-64165	CBW-63-14165	CBW-63-34165	CBW-63-64165
120 208V	3P+N+G	CB-63-14167	CB-63-34167	CB-63-64167	CBW-63-14167	CBW-63-34167	CBW-63-64167
125V	1P+N+G	CB-63-14075	CB-63-34075	CB-63-64075	CBW-63-14075	CBW-63-34075	CBW-63-64075
125 250V	2P+N+G	CB-63-14076	CB-63-34076	CB-63-64076	CBW-63-14076	CBW-63-34076	CBW-63-64076
208V	2P+G	CB-63-14162	CB-63-34162	CB-63-64162	CBW-63-14162	CBW-63-34162	CBW-63-64162
208V	3P+G	CB-63-14163	CB-63-34163	CB-63-64163	CBW-63-14163	CBW-63-34163	CBW-63-64163
250V	2P+G	CB-63-14072	CB-63-34072	CB-63-64072	CBW-63-14072	CBW-63-34072	CBW-63-64072
250V	3P+G	CB-63-14073	CB-63-34073	CB-63-64073	CBW-63-14073	CBW-63-34073	CBW-63-64073
277V	1P+N+G	CB-63-14045	CB-63-34045	CB-63-64045	CBW-63-14045	CBW-63-34045	CBW-63-64045
277 480V	3P+N+G	CB-63-14047	CB-63-34047	CB-63-64047	CBW-63-14047	CBW-63-34047	CBW-63-64047
480V	2P+G	CB-63-14042	CB-63-34042	CB-63-64042	CBW-63-14042	CBW-63-34042	CBW-63-64042
480V	3P+G	CB-63-14043	CB-63-34043	CB-63-64043	CBW-63-14043	CBW-63-34043	CBW-63-64043

For international configurations and ratings (IEC, CE) visit meltric.com/international-catalog or contact customer service at 800.433.7642.

Main Options



Auxiliary/Pilot Contacts



Mushroom Pawl



Padlock Pawl



Closed Lid Configuration

Recommended for cord applications to keep lid tucked in to avoid damage.

Receptacle Options

Suffix

Circuit Protection Options

Part

With 2 Auxiliary/Pilot Contacts (30/60A only)	Recept # - 972	"D" Trip Curve (20/30A only)	Part # - D
With 3 Auxiliary/Pilot Contacts (60A only)	Recept # - 973+	"B" Trip Curve (60A only)	Part # - B
With 4 Auxiliary/Pilot Contacts (60A only)	Recept # - 974+	Standard circuit protectors include a "C" trip curve	
Mushroom Pawl	Recept # - 375	20A: Eaton 20A, 480V 'WMZT' circuit breaker*	
Padlock Pawl	Recept # - 843	30A: Eaton 30A, 480V 'WMZT' circuit breaker*	
Closed Lid Configuration	Recept # - NC	60A: Eaton 63A, 480V 'WMZS' supplementary protector**	

Notes: + Not UL/CSA listed.
 * or equivalent UL 489 circuit breaker
 ** or equivalent UL 1077 supplementary protector

! See pages 248-257 for detailed information on these options



STAINLESS STEEL BOXES with Circuit Breakers

Standard Box



Box with Viewing Window



North American UL/CSA Configurations

Voltage	Polarity	Part #			Part #		
		20A	30A	60A	20A	30A	60A
120V	1P+N+G	CBSS-63-14165	CBSS-63-34165	CBSS-63-64165	CBWSS-63-14165	CBWSS-63-34165	CBWSS-63-64165
120 208	3P+N+G	CBSS-63-14167	CBSS-63-34167	CBSS-63-64167	CBWSS-63-14167	CBWSS-63-34167	CBWSS-63-64167
125V	1P+N+G	CBSS-63-14075	CBSS-63-34075	CBSS-63-64075	CBWSS-63-14075	CBWSS-63-34075	CBWSS-63-64075
125 250	2P+N+G	CBSS-63-14076	CBSS-63-34076	CBSS-63-64076	CBWSS-63-14076	CBWSS-63-34076	CBWSS-63-64076
208V	2P+G	CBSS-63-14162	CBSS-63-34162	CBSS-63-64162	CBWSS-63-14162	CBWSS-63-34162	CBWSS-63-64162
208V	3P+G	CBSS-63-14163	CBSS-63-34163	CBSS-63-64163	CBWSS-63-14163	CBWSS-63-34163	CBWSS-63-64163
250V	2P+G	CBSS-63-14072	CBSS-63-34072	CBSS-63-64072	CBWSS-63-14072	CBWSS-63-34072	CBWSS-63-64072
250V	3P+G	CBSS-63-14073	CBSS-63-34073	CBSS-63-64073	CBWSS-63-14073	CBWSS-63-34073	CBWSS-63-64073
277V	1P+N+G	CBSS-63-14045	CBSS-63-34045	CBSS-63-64045	CBWSS-63-14045	CBWSS-63-34045	CBWSS-63-64045
277 480	3P+N+G	CBSS-63-14047	CBSS-63-34047	CBSS-63-64047	CBWSS-63-14047	CBWSS-63-34047	CBWSS-63-64047
480V	2P+G	CBSS-63-14042	CBSS-63-34042	CBSS-63-64042	CBWSS-63-14042	CBWSS-63-34042	CBWSS-63-64042
480V	3P+G	CBSS-63-14043	CBSS-63-34043	CBSS-63-64043	CBWSS-63-14043	CBWSS-63-34043	CBWSS-63-64043

For international configurations and ratings (IEC, CE) visit meltric.com/international-catalog or contact customer service at 800.433.7642.

UL/CSA Ratings

- **Voltage**
20A: 480 VAC
30A: 480 VAC
60A: 480 VAC
- **Environmental Ratings**
Overall: NEMA Type 4X
Box: NEMA Type 4X, 12
Receptacle: NEMA Type 4X
- **Temperature Range**
Min -40°F/Max 140°F for 20A & 30A
Min 23°F/Max 104°F for 60A
- **Listings**
Box: UL 508A
Receptacle: UL 2682,
UL 1682, CSA 22.2 No. 182.1,
IEC 60309-1
Breaker: UL 489 for 20A & 30A,
UL 1077 for 60A

Receptacle Options	Suffix #	Circuit Protection Options	Part #
With 2 Auxiliary/Pilot Contacts (30/60A only)	Recept # - 972	"D" Trip Curve (20/30A only)	Part # - D
With 3 Auxiliary/Pilot Contacts (60A only)	Recept # - 973+	"B" Trip Curve (60A only)	Part # - B
With 4 Auxiliary/Pilot Contacts (60A only)	Recept # - 974+	Standard circuit protectors include a "C" trip curve	
Mushroom Pawl	Recept # - 375	20A: Eaton 20A, 480V 'WMZT' circuit breaker*	
Padlock Pawl	Recept # - 843	30A: Eaton 30A, 480V 'WMZT' circuit breaker*	
Closed Lid Configuration	Recept # - NC	60A: Eaton 63A, 480V 'WMZS' supplementary protector**	

Notes: + Not UL/CSA listed.
* or equivalent UL 489 circuit breaker
** or equivalent UL 1077 supplementary protector



Main Options



**Auxiliary/Pilot
Contacts**



**Mushroom
Pawl**



Padlock Pawl



**Closed Lid
Configuration**
Recommended for cord
applications to keep lid
tucked in to avoid damage.

! See pages 248-257 for detailed information on these options

Receptacle/GFCI

Combinations



MELTRIC DSN Series Switch-Rated receptacles pre-mounted on class A listed, UL943 Ground fault circuit interrupters (GFCIs) provide advanced personnel protection to workers. The receptacle/GFCI combinations are simple to install and require a minimal amount of connections. Standard configurations are available from 20A to 100A and up to 250 VAC. For higher voltages or custom configurations a UL508A listing is available.

Protection against nuisance tripping

- Inverse trip time curve minimizes nuisance tripping while maximizing personnel protection
- Trip curve exceeds requirements specified by UL 943
- Measures true RMS value
- Quicker trip time at higher fault currents
- Advanced filtering circuitry
- Grounded neutral protection - helps to prevent accidental, multiple neutral-ground bonding downstream in the system

DSN Receptacle/GFCI Combinations



North American UL/CSA Configurations

Voltage	Polarity	Part #				
		20A	30A	60A	100A	100A
120V	1P+N+G	63-17165-LG8	63-37165-LG8	63-67165-LG8	33-67175-C-K16-LG8	37-67175-C-K16-LG8
208V	3P+G	63-17163-LG8	63-37163-LG8	63-67163-LG8	33-67233-C-K16-LG8	37-67233-C-K16-LG8
250V	3P+G	63-17073-LG8	63-37073-LG8	63-67073-LG8	33-67173-C-K07-LG8	37-67173-C-K07-LG8
480V	3P+G	63-17043-LG8	63-37043-LG8	63-67043-LG8	33-67243-C-K04-LG8	37-67243-C-K04-LG8
600V	3P+G	63-17143-LG8	63-37143-LG8	63-67143-LG8	33-67183-C-K14-LG8	33-67183-C-K14-LG8

Contact MELTRIC technical support for pricing or custom configurations 800-433-2720.

Ratings/Listings

Environmental	Type 4X
GFCI	Class A listed UL943 for personnel protection Up to 250V, 100A UL508A listed 480Vac and higher

ORDERING INFORMATION FOR OPTIONAL CONFIGURATIONS

To order optional stainless steel, change suffix “-LG8” to “LG9”.	Example: 120 VAC (1P+N+G) = 63-17165-LG9
To order Emergency Stop Button, add suffix -S to the part number.	Example: 120 VAC (1P+N+G) = 63-17165-LG8-S

Disconnects

Safety Switch/Receptacle Combinations

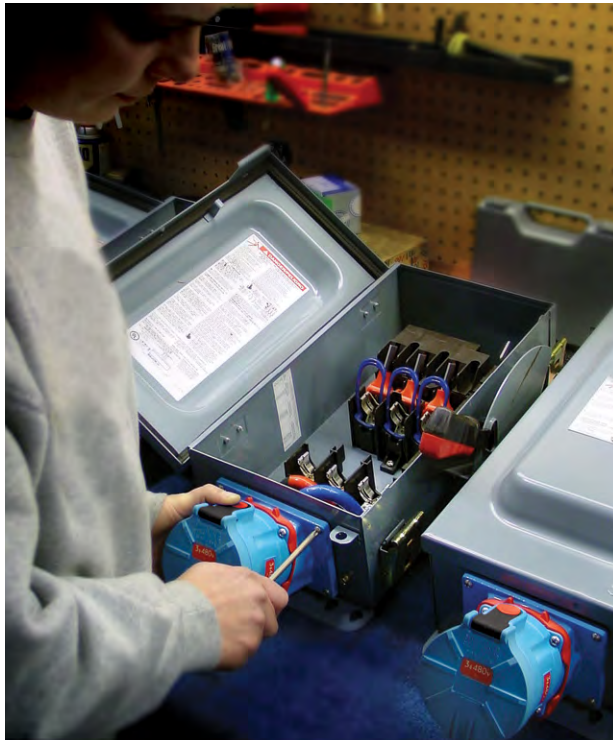

MELTRIC's non-interlocked safety switch disconnects are intended for use in power supply applications where additional over current and short circuit protection is desired. Since Decontactor™ Series products are UL and CSA Switch-rated, there is no need for the receptacle to be interlocked to the switch. The load may be safely made or broken by throwing the switch lever or by simply connecting or disconnecting the plug.

The standard MELTRIC Safety Switch Disconnect consists of a DS Series receptacle and angle mounted and wired to a heavy duty, single throw, fusible safety switch. They can optionally be provided with DSN or DB series Decontactors, straight mounting adapters, non-fused switches, or with circuit breaker protection.

Options:

DSN Receptacle (DS is standard)

DB Receptacle

Straight Adapter (Angle is standard)

Non-Fused (Fused is standard)

Viewing Window

Reverse Service

Canadian CSA listed enclosure



RECEPTACLE/DISCONNECT COMBINATIONS



Voltage	Polarity	Part #	Part #		Part #		Part #
		30A Poly	60A Poly	60A Metal	100A Poly	100A Metal	200A Metal
120V	1P+N+G	33-37165-22X	33-67166-22X	37-67165-22X	33-97166-22X	37-97165-22X	37-27165-22X
120 208	2P+N+G	33-37166-22X	33-67166-22X	37-67166-22X	33-97166-22X	37-97166-22X	37-27166-22X
120 208	3P+N+G	33-37167-42X	33-67167-42X	37-67167-42X	33-97167-42X	37-97167-42X	37-27167-42X
125 250	2P+N+G	33-37076-22X	33-67076-22X	37-67076-22X	33-97076-22X	37-97076-22X	37-27076-22X
208V	3P+G	33-37163-32X	33-67163-32X	37-67163-32X	33-97163-32X	37-97163-32X	37-27163-32X
208V	2P+G	33-37162-12X	33-67162-12X	37-67162-12X	33-97162-12X	37-97162-12X	37-27162-12X
250V	2P+G	33-37072-12X	33-67072-12X	37-67072-12X	33-97072-12X	37-97072-12X	37-27072-12X
480V	2P+G	33-37042-12X	33-67042-12X	37-67042-12X	33-97042-12X	37-97042-12X	37-27042-12X
277 480	2P+N+G	33-37046-22X	33-67046-22X	37-67046-22X	33-97046-22X	37-97046-22X	37-27046-22X
277 480	3P+N+G	33-37047-42X	33-67047-42X	37-67047-42X	33-97047-42X	37-97047-42X	37-27047-42X
480V	3P+G	33-37043-32X	33-67043-32X	37-67043-32X	33-97043-32X	37-97043-32X	37-27043-32X
347 600V	2P+N+G	33-37146-22X	33-67146-22X	37-67146-22X	33-97146-22X	37-97146-22X	-
347 600V	3P+N+G	33-37147-42X	33-67147-42X	37-67147-42X	33-97147-42X	37-97147-42X	-
600V	3P+G	33-37143-32X	33-67143-32X	37-67143-32X	33-97143-32X	37-97143-32X	-
600V	2P+G	33-37142-12X	33-67142-12X	37-67142-12X	33-97142-12X	37-97142-12X	-

- Notes:**
- When ordering a Safety Switch Disconnect, replace the "X" with the appropriate number that represents the NEMA Rating of choice.
 - For higher amperage devices, contact MELTRIC's Sales Office.

NEMA GUIDELINES

X (NUMBER)	NEMA RATING
9	Type 4X
7	Type 12
5	Type 3R
1	Type 1

ORDERING INFORMATION FOR OPTIONAL CONFIGURATIONS

DSN Receptacle	To order a DSN receptacle (20-60A), change prefix "33" to "63".	Example: DSN 60A Poly Receptacle 250 VAC (2P+G) Type 1 = 63-67072-121
DB Receptacle	To order a DB receptacle (30-100A), change prefix "33" or "37" to "89".	Example: DB 60A Metal Receptacle 250 VAC (2P+G) Type 4X = 89-67072-129
Straight Adapter	To order a straight adapter, add suffix -S to the part number.	Example: DS 60A Metal Receptacle 480 VAC (3P+G) Type 1 = 37-67043-321-S
Non-Fused	To order a non fused device, add suffix -NF to the part number.	Example: DS 30A Poly Receptacle 250 VAC (2P+G) Type 3R = 33-37072-125-NF
Canadian	To order a CSA listed enclosure, add suffix -CSA to the part number. CSA enclosures are provided with viewing windows as standard.	

SPECIALTY PRODUCTS



MELTRIC manufactures a wide variety of specialty products to fit specific application needs and to help users benefit from the advantages of MELTRIC's switch-rated plugs and receptacles where ever connections may need to be made and broken.



WS P. 174

WELDING CONNECTORS

- 200A or 300A sizes
- 50 VAC max
- Amperage: 325A continuous or 500A intermittent



CORD GRIPS P. 178

FOR SECURE CORD MOUNTING

- Poly or metal
- With or without mesh
- Non-hazardous or hazardous locations

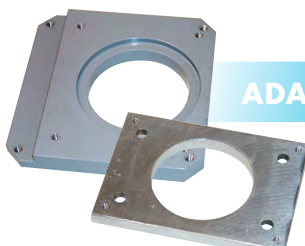

ADAPTER PLATES P. 175

FOR EASY RETROFITS

- Install on existing back box, disconnect switch, or mechanical interlock
- Standard or custom plates available



VOLTAGE METER P. 180

FOR TESTING MELTRIC RECEPTACLES

- 20A to 200A sizes
- Test voltage or motor rotation
- Featuring DSN, DS, DB male inlets

WS Welding Connectors

General Ratings

- **Voltage**
50 VAC Max
- **Amperage**
325A Continuous
500A Intermittent

WS devices allow users to make fast and reliable connections of welding cables. Their spring-loaded silver contacts provide connections that are unaffected by cable movement or vibration and operate with a self-cleaning wiping action that ensures a reliable electrical connection every time.

Wiring Hole (in ²) (mm ²)	Current Interruption Capabilities		
	30% Duty	60% Duty	100% Duty
.025 16	150A	100A	75A
.047 30	200A	125A	100A
.062 40	250A	150A	125A
.078 50	300A	200A	150A
.116 75	350A	250A	200A
.155 100	400A	300A	250A
.186 120	450A	350A	275A
.233 150	500A	450A	325A

 The chart to the right is a guideline for wiring sizes based on duty cycles.

Application Note

Interchangeability

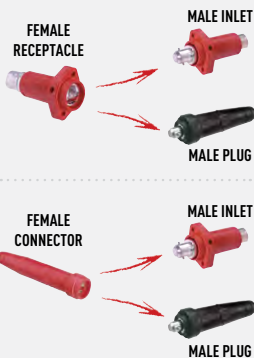

Receptacle Lug Type Connection (female)



Wiring Hole (in ²) (mm ²)	Type 2 200A	Type 3 300A
.025 16	4-2401-A	
.047 30	4-2401-B	
.062 40	4-2401-C	
.078 50	4-2401-D	4-3401-E
.116 75		4-3401-F
.155 100		4-3401-G

Inlet Lug Type Connection (male)



Wiring Hole (in ²) (mm ²)	Type 2 200A	Type 3 300A
.025 16	4-2901-A	
.047 30	4-2901-B	
.062 40	4-2901-C	
.078 50	4-2901-D	4-3901-E
.116 75		4-3901-F
.155 100		4-3901-G

Connector Crimp/Solder Connection (female)



Wiring Hole (in ²) (mm ²)	Type 2 200A	Type 3 300A
.025 16	4-2301-A	
.047 30	4-2301-B	
.062 40	4-2301-C	
.078 50	4-2301-D	4-3301-E
.116 75		4-3301-F
.155 100		4-3301-G

Plug Crimp/Solder Connection (male)



Wiring Hole (in ²) (mm ²)	Type 2 200A	Type 3 300A
.025 16	4-0201-A	
.047 30	4-0201-B	
.062 40	4-0201-C	
.078 50	4-0201-D	4-0301-E
.116 75		4-0301-F
.155 100		4-0301-G

Adapter Plates

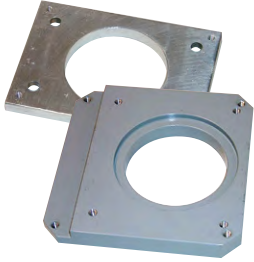

Updating your facility with Meltric plugs and receptacles is simple and affordable with MELTRIC's adapter plates. They allow the mounting of meltric devices to existing boxes previously used for competitive devices. This avoids the cost and hassle of installing new boxes and performing associated re-piping and rewiring. If an adapter plate for the box you have is not listed, contact customer service and MELTRIC will design a new one to fit your application.

Install MELTRIC on virtually any existing back box
No need to bend conduit or pull wires.

MELTRIC Adapter Plates
Available for hundreds of competitive wall boxes, disconnect switches and mechanical interlocks.

MELTRIC Receptacle

MELTRIC Part #	MELTRIC Devices	Description	Part Numbers Adapted to:		MELTRIC Part #	MELTRIC Devices	Description	Part Numbers Adapted to:	
CHARE36	DS30/DSN60 Recp/Inlet DS(N)37 Recp/Inlet	<i>Appleton and Crouse-Hinds</i>	Appleton Crouse-Hinds		CHARE56	DS60 Recp/Inlet DS100C Recp/Inlet	<i>Appleton and Crouse-Hinds</i>	Appleton Crouse-Hinds	
			AEE36	ARE36				AEE36	ARE36
			AEE46	ARE46				AEE46	ARE46
			AEE56	ARE56				AEE56	ARE56
			AERH36	ARRH36				AERH36	ARRH36
			AERH46	ARRH46				AERH46	ARRH46
			AERH56	ARRH56				AERH56	ARRH56
			AERC36	ARRC36				AERC36	ARRC36
			AERC46	ARRC46				AERC46	ARRC46
			AERC56	ARRC56				AERC56	ARRC56
			AERA36	ARD36				AERA36	ARD36
			AERA46	ARD46				AERA46	ARD46
			AERA56	ARD56				AERA56	ARD56
			AJA310	ARJ36				AJA310	ARJ36
			AJA410	ARJ46				AJA410	ARJ46
			AJA510	ARJ56				AJA510	ARJ56
			AJA610	ARJG36				AJA610	ARJG36
AJ100	ARJG46	AJ100	ARJG46						
	ARJG56		ARJG56						
	AR60		AR60						
	AR610		AR610						
	AJ37		AJ37						
	AJ47		AJ47						
	AJ57		AJ57						
	AJ67		AJ67						

SPECIALTY PRODUCTS

ADAPTER PLATES

MELTRIC Part #	MELTRIC Devices	Description	Part Numbers Adapted to:		MELTRIC Part #	MELTRIC Devices	Description	Part Numbers Adapted to:	
CHARE56	DS60 Recp/Inlet	Appleton and Crouse-Hinds	Appleton Crouse-Hinds		CHAJ56-MA6	MP6	Appleton and Crouse-Hinds	AJA310	AJ37
	DS100C Recp/Inlet		AJ67	AJA6		AJA410		AJ47	
AJA100	DS100 Recp/Inlet	Appleton and Crouse-Hinds	Appleton Crouse-Hinds		CHFADAPLT	MS6	FS/FD Single Gang Box	AJA510	AJ57
			AJA310	AR610		AJA610		AJ67	
			AJA410	AJ37					
			AJA510	AJ47					
			AJA610	AJ57					
			AJ100	AJ67					
				AJC37					
				AJC47					
	AJC57								
	AJC67								
CHARE23	DS20/DSN30 Recp/Inlet DSINJ24 Recp/Inlet		Appleton Crouse-Hinds		E462	61-10000-027	FS/FD Single Gang Box	RUSSELL STOLL	
			AEE13	ARE13				JAA6-AB6	
			AEE23	ARE23				JAA6-45	
			AEE33	ARE33				JRAA-AB6	
			AERH13	ARRC13				JE6	
			AERH23	ARRC23				RUSSELL STOLL	
			AERH33	ARRC33				RUSSELL STOLL	
			AERC13	ARRH13				JAAB6	
			AERC23	ARRH23				RUSSELL STOLL	
			AERC33	ARRH33				RUSSELL STOLL	
			AERA13	ARD13				JAA6-AB6	
			AERA23	ARD23				JAA6-45	
			AERA33	ARD33				JRAA-AB6	
				AR30				JE6	
				ARJ13				JAAB6	
			CHARE33	DS30/DSN60 Recp/Inlet DSINJ37 Recp/Inlet				Appleton and Crouse-Hinds	Appleton Crouse-Hinds
AEE13	ARE13	26401							
AEE23	ARE23	BB601W							
AEE33	ARE33	BB602W							
AERH13	ARRC13	BB1001W							
AERH23	ARRC23	BB1002W							
AERH33	ARRC33	FW60100							
AERC13	ARRH13	HUBBELL							
AERC23	ARRH23	26401							
AERC33	ARRH33	BB601W							
AERA13	ARD13	BB602W							
AERA23	ARD23	BB1001W							
AERA33	ARD33	BB1002W							
	AR30	FW60100							
	ARJ13	KILLARK							
CHAJ56-MA6	MP6 MA6 MS6	Appleton and Crouse-Hinds			Appleton Crouse-Hinds		HH312		MA6
			AJA310	AR610	26401				
			AJA410	AJ37	BB601W				
			AJA510	AJ47	BB602W				
			AJA610	AJ57	BB1001W				
			AJ100	AJ67	BB1002W				
				AJC37	FW60100				
				AJC47	HUBBELL				
CHARE23	DS20/DSN30 Recp/Inlet DSINJ24 Recp/Inlet		Appleton Crouse-Hinds		HH312-E448	DS60 Recp/Inlet	Hubbell/60/100A Boxes	HUBBELL	
			AEE13	ARE13				26401	
			AEE23	ARE23				BB601W	
			AEE33	ARE33				BB602W	
			AERH13	ARRC13				BB1001W	
			AERH23	ARRC23				BB1002W	
			AERH33	ARRC33				FW60100	
			AERC13	ARRH13				HUBBELL	
			AERC23	ARRH23				26401	
			AERC33	ARRH33				BB601W	
			AERA13	ARD13				BB602W	
			AERA23	ARD23				BB1001W	
			AERA33	ARD33				BB1002W	
				AR30				FW60100	
				ARJ13				KILLARK	
			CHAJ56-MA6	MP6 MA6 MS6				Appleton and Crouse-Hinds	Appleton Crouse-Hinds
AJA310	AR610	AJAE							
AJA410	AJ37	AJAC							
AJA510	AJ47	AJAT							
AJA610	AJ57	HUBBELL							
AJ100	AJ67	HUBBELL							
	AJC37	HUBBELL							
	AJC47	HUBBELL							
CHARE23	DS20/DSN30 Recp/Inlet DSINJ24 Recp/Inlet		Appleton Crouse-Hinds		MAFS6BA	MA6	FS/FD Single Gang Box	HUBBELL	
			AEE13	ARE13				HUBBELL	
			AEE23	ARE23				HUBBELL	
			AEE33	ARE33				HUBBELL	
			AERH13	ARRC13				HUBBELL	
			AERH23	ARRC23				HUBBELL	
			AERH33	ARRC33				HUBBELL	
			AERC13	ARRH13				HUBBELL	
AERC23	ARRH23	HUBBELL							
AERC33	ARRH33	HUBBELL							
AERA13	ARD13	HUBBELL							
AERA23	ARD23	HUBBELL							
AERA33	ARD33	HUBBELL							
	AR30	HUBBELL							
	ARJ13	HUBBELL							
	ARJ23	HUBBELL							
	ARJ33	HUBBELL							
	ARJG13	HUBBELL							
	ARJG23	HUBBELL							
	ARJG33	HUBBELL							
CHAJ56-MA6	MP6 MA6 MS6	Appleton and Crouse-Hinds	Appleton Crouse-Hinds		HHBB201W	DS1/DSN3 Recp/Inlet	Hubbell /20/30A Boxes	HUBBELL	
			AJA310	AR610				HUBBELL	
			AJA410	AJ37				HUBBELL	
			AJA510	AJ47				HUBBELL	

MELTRIC Part #	MELTRIC Devices	Description	Part Numbers Adapted to:	MELTRIC Part #	MELTRIC Devices	Description	Part Numbers Adapted to:
HHBB201W	DS1/DSN3 Recp/Inlet	Hubbell /20/30A Boxes	HUBBELL	PLN30	09-20000-027-80	Pyle-National/60A Boxes	PYLE-NATIONAL
			BB301W				JR-26046-A
			FT202W				JR-36046-A
			FT302W				JR-46046-A
			HUBBELL				JR-56046-A
HBL26401	DS30/DSN60 Recp/Inlet	Hubbell/60/100A Boxes 60/100A Boxes	26401	MA2			JR-336046-C
			BB601W	MA3			JR-446046-C
			BB602W	MS2			JR-556046-C
			BB1001W	MS3			JR-26046-BB
HBL26401	DS30/DSN60 Recp/Inlet	Hubbell/60/100A Boxes 60/100A Boxes	JAA6-BB1002W				JR-36046-BB
			FW60100				JR-46046-BB
HBL26401A	DS3/DSN6 Angle Adapter	Hubbell/60/100A Boxes	26401				JR-56046-BB
			HUBBELL				JR-36046-BE
AP-CHAJA1-DS200	DS200 Receptacle	Hubbell 200A Boxes	4200				JR-46046-BE
HHB26401	DS60 Adapters	Hubbell/60/100A Boxes	26401				JR-56046-BE
HH50	DS30/DSN60 Recp/Inlet	Hubbell/lock/60A adapters 60A adapters	26402				JR-46046-CE
			26404				JR-56046-CE
PNFS	PN/DSN20 Recp/Inlet	FS /FD Single Gang Box					JR-60-F
			PYLE-NATIONAL				JR-64-D
PNFSPL	DS60 Recp/Inlet	Pyle-National/60A Boxes	JR-26046-A	PLN60	MP6	Pyle-National/60A Boxes	PYLE-NATIONAL
	DS100C Recp/Inlet	60A Boxes	JR-36046-A				JR-26046-A
			JR-46046-A				JR-36046-A
			JR-56046-A				JR-46046-A
			JR-336046-C				JR-56046-A
			JR-446046-C				JR-336046-C
			JR-556046-C				JR-446046-C
			JR-26046-BB				JR-556046-C
			PYLE-NATIONAL				JR-26046-BB
			JR-36046-BB				JR-36046-BB
			JR-46046-BB				JR-46046-BB
			JR-56046-BB				JR-56046-BB
			JR-36046-BE				JR-36046-BE
			JR-46046-BE				JR-46046-BE
			JR-56046-BE				JR-56046-BE
			JR-46046-CE				JR-46046-CE
			JR-56046-CE				JR-56046-CE
			JR-60-J				JR-60-F
			JR-64-D				JR-64-D
			PYLE-NATIONAL	AP-RACO4X4-FS	MAFS1	4"x4" sheet metal boxes	
PNJRB30	09-20000-027-80	Pyle-National	JRW-13046-A		MAFS2		
	MSPN	20/30A Boxes	JRW-23046-A		MAFS3		
	MP2		JRW-33046-A				
	MP3		JRW-113046-C				
	MA2		JRW-223046-C				
	MA3		JRW-333046-C				
	MS2		JR-13046-BB				
	MS3		JR-23046-BB				
			JR-33046-BB				
			JR-43046-BB				
			JRW-13046-BE				
			JRW-23046-BE				
			JRW-33046-BE				
			JR-23046-CE				

Cord Grips

Poly Cord Grips



Aluminum Cord Grips



Handle NPT C	Cable Range B	Part # Cord Grip	Part # Cord Grip w/Mesh
1/2"	.312-.375	CG121P	CG121PM
1/2"	.375-.438	CG122P	CG122PM
1/2"	.438-.500	CG123P	CG123PM
1/2"	.500-.562	CG124P	CG124PM
1/2"	.562-.625	CG125P	CG125PM
3/4"	.438-.500	CG340P	CG340PM
3/4"	.500-.562	CG341P	CG341PM
3/4"	.562-.625	CG342P	CG342PM
3/4"	.625-.750	CG344P	CG344PM
3/4"	.688-.812	CG345P	CG345PM
1"	.660-.780	CG1001P	-
1"	.770-.895	CG1002P	-
1"	.870-1.020	CG1003P	-
1"	.875-1.000	CG1004P	-
1 1/4"	.875-1.000	CG1141P	-
1 1/4"	1.000-1.125	CG1142P	-
1 1/4"	1.270-1.470	CG1143P	-
1 1/4"	-	-	-
1 1/2"	.890-1.150	CG1121P	-
1 1/2"	1.140-1.400	CG1122P	-
1 1/2"	-	-	-
1 1/2"	-	-	-
2"	1.190-1.530	CG2001P	-
2"	1.520-1.860	CG2002P	-
2"	1.850-2.190	CG2003P	-
2"	-	-	-
2"	-	-	-
2"	-	-	-
2 1/2"	-	-	-
2 1/2"	-	-	-
2 1/2"	-	-	-
3"	-	-	-
3"	-	-	-

Cable Range B	Part # Cord Grip	Part # Cord Grip w/Mesh
.312-.375	CG121A	CG121AM
.375-.438	CG122A	CG122AM
.438-.500	CG123A	CG123AM
.500-.562	CG124A	CG124AM
.562-.625	CG125A	CG125AM
.438-.500	CG340A	CG340AM
.500-.562	CG341A	CG341AM
.562-.625	CG342A	CG342AM
.625-.750	CG344A	CG344AM
.688-.812	CG345A	CG345AM
.750-.875	CG1001A	CG1001AM
.812-.938	CG1002A	CG1002AM
.875-1.000	CG1003A	-
-	-	-
.875-1.000	CG1141A	CG1141AM
1.000-1.125	CG1142A	CG1142AM
*1.125-1.250	CG1143A	CG1143AM
*1.250-1.375	CG1144A	CG1144AM
1.250-1.375	CG1121A	CG1121AM
1.438-1.562	CG1122A	CG1122AM
*1.562-1.688	CG1123A	CG1123AM
*1.688-1.812	CG1124A	CG1124AM
1.688-1.812	CG2001A	CG2001AM
*1.812-1.938	CG2002A	CG2002AM
*1.938-2.062	CG2003A	CG2003AM
*2.062-2.188	CG2004A	CG2004AM
*2.188-2.312	CG2005A	CG2005AM
*2.312-2.438	CG2006A	CG2006AM
2.062-2.188	CG2121A	CG2121AM
2.188-2.312	CG2122A	CG2122AM
*2.312-2.438	CG2123A	CG2123AM
2.437-2.625	CG3001A	CG3001AM
2.625-2.812	CG3002A	CG3002AM

Notes: * Cable may have to be stripped to pass through the bore of the cord grip body (A).

Metal Cord Grips for Hazardous Locations

For use with Class I/II Division 2
Class 1 Zone 1
Zone 21

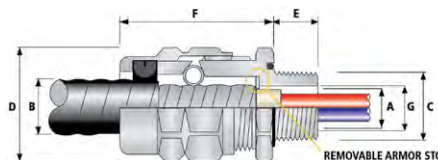

TMC2 Hazardous (Classified) Location Cord Grips for use with Corrugated & Interlocked Metal Clad Armor (MC) or TECK90, Continuously Welded Metal Clad Armor (MCHL), ACIC-HL, ACWU90-HL, RC90-HL, RA90-HL with an overall jacket of polymeric material.

Part # Cord Grip	Material	Entry Thread "C"	Minimum Thread Length "E"	Cable Armor Diameter "A"				Cable Jacket Diameter "B"		Thru Bore "G"	Across Flats "D"	Across Corners "D"	Nominal Assembly Length "F"
				Armor Stop In		Armor Stop Out		Min	Max				
				Min	Max	Min	Max						
TMC2-050NB075	Nickel Plated Brass	1/2"	0.78"	0.42"	0.55"	0.55"	0.63"	0.50"	0.75"	0.51"	1.20"	1.32"	2.44"
TMC2-050NB099	Nickel Plated Brass	1/2"	0.78"	0.60"	0.65"	0.65"	0.89"	0.69"	0.99"	0.61"	1.48"	1.63"	2.96"
TMC2-075NB118	Nickel Plated Brass	3/4"	0.80"	0.79"	0.86"	0.86"	1.10"	0.87"	1.18"	0.82"	1.81"	1.99"	3.15"
TMC2-100NB137	Nickel Plated Brass	1"	0.98"	0.94"	1.08"	1.08"	1.28"	1.02"	1.37"	1.04"	2.05"	2.26"	3.55"

For use with Class I/II Division 2
Class 1 Zone 1
Zone 21

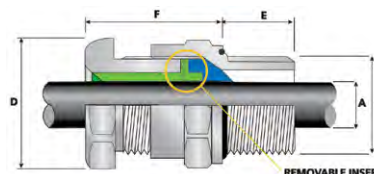

TC Hazardous (Classified) Location Cord Grips for use with all types of Unarmored Tray Cables, Extra Hard Usage Flexible Cables & Cord.

Part # Cord Grip	Material	Entry Thread "C"	Minimum Thread Length "E"	Cable Range "A"		Cable Range "A"		Across Flats "D"	Across Corners "D"	Nominal Assembly Length "F"
				Insert		No Insert				
				Min	Max	Min	Max			
TC-050NB028	Nickel Plated Brass	1/2"	0.78"	0.126"	0.276"	N/A	N/A	1.201"	1.321"	1.200"
TC-050NB055	Nickel Plated Brass	1/2"	0.78"	0.256"	0.406"	0.406"	0.551"	1.201"	1.323"	1.200"
TC-075NB079	Nickel Plated Brass	3/4"	0.80"	0.437"	0.610"	0.610"	0.787"	1.476"	1.626"	1.200"
TC-100NB104	Nickel Plated Brass	1"	0.98"	0.669"	0.854"	0.854"	1.035"	1.811"	1.992"	1.650"

Fiber Reinforced Nylon Cord Grips for Hazardous Locations

For use with Class I/II Division 2
Class 1 Zone 1
Zone 21

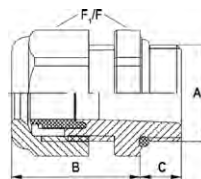

Part # Cord Grip	Cable Range	Thread Type & Size	Dimensions (inches)			
			Clearance Hole	Body Length	Thread Length	Wrench Flats
			"A"	"B"	"C"	"F, F"
CD13NA-BXA	.24 - .47"	1/2"	0.83"	1.06"	.51"	.95"
CD16NA-BXA	.39 - .55"	1/2"	0.83"	1.10"	.51"	1.06"
CD21NA-BXA	.51 - .71"	3/4"	1.05"	1.22"	.55"	1.29"
CD21NR-BXA	.35 - .63"					
CD29NA-BXA	.71 - .98"	1"	1.35"	1.53"	.75"	1.65"
CD29NR-BXA	.51 - .79"					

VOLTAGE/PHASE ROTATION Meter Assemblies



Voltage/Phase Rotation Meters offer customers an easy means of testing MELTRIC receptacles for voltage, as well as, motor rotation. The product consists of an inlet and handle wired to the meter. Smaller devices use standard poly handles, while larger devices are provided with PH handles and cord-grips.

Order Example

The plug with voltage rotation meter assembly should be ordered to match the receptacles to be tested.



Existing 63-64043 receptacle



Matching plug with voltage phase rotation meter assembly 63-61043-MTR

Switch-Rated Inlet and Voltage/Phase Rotation Meter Assemblies DSN Series

Voltage	Polarity	Part #		
		20A	30A	60A
120V	1P+N+G	63-11165-MTR	63-31165-MTR	63-61165-MTR
120 208V	3P+N+G	63-11167-MTR	63-31167-MTR	63-61167-MTR
125V	1P+N+G	63-11075-MTR	63-31075-MTR	63-61075-MTR
125 250V	2P+N+G	63-11076-MTR	63-31076-MTR	63-61076-MTR
208V	2P+G	63-11162-MTR	63-31162-MTR	63-61162-MTR
208V	3P+G	63-11163-MTR	63-31163-MTR	63-61163-MTR
250V	2P+G	63-11072-MTR	63-31072-MTR	63-61072-MTR
250V	3P+G	63-11073-MTR	63-31073-MTR	63-61073-MTR
277V	1P+N+G	63-11045-MTR	63-31045-MTR	63-61045-MTR
277 480V	3P+N+G	63-11047-MTR	63-31047-MTR	63-61047-MTR
347 600V	3P+N+G	63-11147-MTR	63-31147-MTR	63-61147-MTR
480V	2P+G	63-11042-MTR	63-31042-MTR	63-61042-MTR
480V	3P+G	63-11043-MTR	63-31043-MTR	63-61043-MTR
600V	2P+G	63-11142-MTR	63-31142-MTR	63-61142-MTR
600V	3P+G	63-11143-MTR	63-31143-MTR	63-61143-MTR

Notes: • Only the voltage indication function will work for single phase devices. The rotation of the motor cannot be determined because only one phase is in use.

Contact customer service for price and availability of inlet and rotation meter assemblies not published here.

DS Series

Voltage	Polarity	Part #					
		20A	30A	60A	100A	100A	200A
120V	1P+N+G	33-11165-MTR	33-31165-MTR	33-61165-MTR	33-61235-C-K16-MTR	33-91165-MTR	37-21165-MTR
120 208V	3P+N+G	33-11167-MTR	33-31167-MTR	33-61167-MTR	33-61237-C-K16-MTR	33-91167-MTR	37-21167-MTR
125V	1P+N+G	33-11075-MTR	33-31075-MTR	33-61075-MTR	33-61175-C-K07-MTR	33-91075-MTR	37-21075-MTR
125 250V	2P+N+G	33-11076-MTR	33-31076-MTR	33-61076-MTR	33-61176-C-K07-MTR	33-91076-MTR	37-21076-MTR
208V	2P+G	33-11162-MTR	33-31162-MTR	33-61162-MTR	33-61232-C-K16-MTR	33-91162-MTR	37-21162-MTR
208V	3P+G	33-11163-MTR	33-31163-MTR	33-61163-MTR	33-61233-C-K16-MTR	33-91163-MTR	37-21163-MTR
250V	2P+G	33-11072-MTR	33-31072-MTR	33-61072-MTR	33-61172-C-K07-MTR	33-91072-MTR	37-21072-MTR
250V	3P+G	33-11073-MTR	33-31073-MTR	33-61073-MTR	33-61173-C-K07-MTR	33-91073-MTR	37-21073-MTR
277V	1P+N+G	33-11045-MTR	33-31045-MTR	33-61045-MTR	33-61245-C-K04-MTR	33-91045-MTR	37-21045-MTR
277 480V	3P+N+G	33-11047-MTR	33-31047-MTR	33-61047-MTR	33-61247-C-K04-MTR	33-91047-MTR	37-21047-MTR
347 600V	3P+N+G	33-11147-MTR	33-31147-MTR	33-61147-MTR	33-61187-C-K14-MTR	33-91147-MTR	37-21147-MTR
480V	2P+G	33-11042-MTR	33-31042-MTR	33-61042-MTR	33-61242-C-K04-MTR	33-91042-MTR	37-21042-MTR
480V	3P+G	33-11043-MTR	33-31043-MTR	33-61043-MTR	33-61243-C-K04-MTR	33-91043-MTR	37-21043-MTR
600V	2P+G	33-11142-MTR	33-31142-MTR	33-61142-MTR	33-61182-C-K14-MTR	33-91142-MTR	37-21142-MTR
600V	3P+G	33-11143-MTR	33-31143-MTR	33-61143-MTR	33-61183-C-K14-MTR	33-91143-MTR	37-21143-MTR

Notes: • Only the voltage indication function will work for single phase devices. The rotation of the motor cannot be determined because only one phase is in use.
Contact customer service for price and availability of inlet and rotation meter assemblies not published here.

DB Series

Voltage	Polarity	Part #		
		30A	60A	100A
120V	1P+N+G	89-31165-MTR	89-61165-MTR	89-91165-MTR
120 208V	3P+N+G	89-31167-MTR	89-61167-MTR	89-91167-MTR
125V	1P+N+G	89-31075-MTR	89-61075-MTR	89-91075-MTR
125 250V	2P+N+G	89-31076-MTR	89-61076-MTR	89-91076-MTR
208V	2P+G	89-31162-MTR	89-61162-MTR	89-91162-MTR
208V	3P+G	89-31163-MTR	89-61163-MTR	89-91163-MTR
250V	2P+G	89-31072-MTR	89-61072-MTR	89-91072-MTR
250V	3P+G	89-31073-MTR	89-61073-MTR	89-91073-MTR
277V	1P+N+G	89-31045-MTR	89-61045-MTR	89-91045-MTR
277 480V	3P+N+G	89-31047-MTR	89-61047-MTR	89-91047-MTR
347 600V	3P+N+G	89-31147-MTR	89-61147-MTR	89-91147-MTR
480V	2P+G	89-31042-MTR	89-61042-MTR	89-91042-MTR
480V	3P+G	89-31043-MTR	89-61043-MTR	89-91043-MTR
600V	2P+G	89-31142-MTR	89-61142-MTR	89-91142-MTR
600V	3P+G	89-31143-MTR	89-61143-MTR	89-91143-MTR

Notes: • Only the voltage indication function will work for single phase devices. The rotation of the motor cannot be determined because only one phase is in use.
Contact customer service for price and availability of inlet and rotation meter assemblies not published here.

HAZARDOUS LOCATION

Plugs & Receptacles



MELTRIC offers a wide range of hazardous location devices for use in power supply and control applications. Each device features MELTRIC's butt-style contact technology that maximizes durability and performance.



DXN P. 186

POLY POWER CONNECTORS

- ATEX or cCSAus rated
- Horsepower rated
- Compact design
- 20A, 30A and 60A sizes



DR P. 216

POWER CONNECTORS

- cCSAus rated, Zone 2 and Class I Div 2
- Robust metal construction for 60A and above
- 30A, 50A, 100A and 250A sizes



DXA1 P. 198

POWER CONNECTORS

- ATEX or cCSAus rated
- Robust metal construction
- Compact design
- 20A sizes



DSDC P.224

POWER CONNECTORS

- cCSAus rated, Zone 2 and Class I Div 2
- Robust metal construction for 60A and above
- 20A, 30A, 60A, 100A, and 200A sizes



DSN/DS P. 204

POWER CONNECTORS

- cCSAus rated, Zone 2 and Class I Div 2
- Horsepower rated
- Robust metal construction for 60A and above
- 20A, 30A, 60A, 100A, 150A and 200A sizes



DX P. 226

POWER CONNECTORS

- ATEX Rated for Zone 1 and Zone 21
- Rugged metal construction
- 20A, 32A, 63A, and 125A sizes
- Up to 600V, IP65

The MELTRIC Advantage

MELTRIC offers a range of hazardous duty rated devices for use in power supply and control applications. Each device features MELTRIC's butt-style contact technology that maximizes durability and performance. Depending on application needs, most devices can be configured for use in in-line and wall mounted applications.

Common industry applications:

- ▶ Chemical plants
- ▶ Pharmaceutical plants
- ▶ Oil and Gas facilities
- ▶ Grain silos
- ▶ Wood processing plants
- ▶ Plastics plants
- ▶ Wastewater plants



"Flush Mounted" DX Series plug and receptacle



"Inline" DXN Series plug and connector

Explanation of Area Classifications and Relevant Listings

The hazardous location area classifications and ratings used in most of North America differ from those used in most of the rest of the world. The North American approach has historically been to use a Class and Division system to identify the different levels of explosion hazards, while the international approach is based on Zones. In recent years, there has been recognition of the Zone classifications in the NEC and CEC, but the vast majority of the area classifications in North America continue to be based on the Class and Division system. The table below shows the relationship between the Class/Division and Zone based classification systems.

Gas

Explosive atmosphere	Continuously present	May occur in normal conditions	May appear accidentally or in abnormal conditions
Class & Division	Class I, Division 1		Class I, Division 2
Zone	Zone 0	Zone 1	Zone 2

Dust

Explosive atmosphere	Continuously present	May occur in normal conditions	May appear accidentally or in abnormal conditions
Class & Division	Class II, Division 1		Class II, Division 2
Zone	Zone 20	Zone 21	Zone 22

Meltric offers hazardous locations products rated for use in Zone 1, Zone 2, Zone 21, Zone 22, Class I Division 2 and Class 2 Division 2 areas as shown by the yellow highlighted cells in the table above. The area classifications, ratings and certifications that apply to each of the various products is shown in the following product specification table.

Selecting the Right Hazardous Location Rated Plug & Receptacle

Hazardous Duty Product Specifications

Zone 1/21 & 2/22, Class I & II Division 2 Devices												
Product Type	Housing Material	Maximum Number of Contacts	Electrical Ratings				Certifications	Environmental Rating	Wiring Capacity		Wiring Connection	Catalog Page
			Max VAC	Amperage	Current Interruption	HP@Max Voltage			Min / Max			
DXN20	Polyester	3P+N+G	600	20	YES	5	cCSAus	IP66/IP67	16 awg	10 awg	Screw	190
DXN30	Polyester	3P+N+G	600	30	YES	15	cCSAus	IP66/IP67	14 awg	6 awg	Screw	192
DXN30	Polyester	3P+N+G + 2 aux	550	30	YES	15	cCSAus	IP66/IP67	14 awg	6 awg	Screw	192
DXN60	Polyester	3P+N+G	600	60	YES	20	cCSAus	IP66/IP67	10 awg	4 awg	Screw	194
DXN60	Polyester	3P+N+G + 2 aux	550	60	YES	20	cCSAus	IP66/IP67	10 awg	4 awg	Screw	194
DXA1	Metal	3P+N+G	600	20	YES	5	cCSAus	IP66/IP67	16 awg	10 awg	Screw	200
SPeX	Polyester	1	1000	680	NO	-	cCSAus	IP66	2/0 awg	750mcm	Lug	244

Zone 2, Class I Division 2 Devices												
Product Type	Housing Material	Maximum Number of Contacts	Electrical Ratings				Certifications	Environmental Rating	Wiring Capacity		Wiring Connection	Catalog Page
			Max VAC	Amperage	Current Interruption	HP@Max Voltage			Min / Max			
DS20	Polyester	3P+N+G + 2 aux	600	20	NO	10	cCSAus	Type 4X	14 awg	8 awg	Screw	204
DS30	Polyester	3P+N+G + 4 aux	600	30	NO	15	cCSAus	Type 4X	14 awg	4 awg	Screw	206
DS60	Metal	3P+N+G + 4 aux	600	60	NO	25	cCSAus	Type 4X	10 awg	2 awg	Screw	208
DS100C	Metal or Poly	3P+N+G + 4 aux	600	100	NO	50	cCSAus	Type 4X	10 awg	2 awg	Screw	210
DSN150	Metal	3P+N+G + 6 aux	600	150	NO	75	cCSAus	Type 4X	4 awg	2/0 awg	Screw	212
DS200	Metal	3P+N+G + 6 aux	600	200	NO	100	cCSAus	Type 4X	4 awg	4/0 awg	Screw	214
DR30	Polyester	3P+N+G + 2 aux	600	30	NO	-	cCSAus	Type 4X	14 awg	8 awg	Screw	216
DR50	Polyester	3P+N+G + 4 aux	600	50	NO	-	cCSAus	Type 4X	14 awg	4 awg	Screw	218
DR100	Metal or Poly	3P+N+G + 4 aux	600	100	NO	-	cCSAus	Type 4X	10 awg	2 awg	Screw	220
DR250	Metal	3P+N+G + 4 aux	600	200	NO	-	cCSAus	Type 4X	4 awg	4/0 awg	Screw	222

Zone 2, Class I Division 2 Devices for Direct Current												
Product Type	Housing Material	Maximum Number of Contacts	Electrical Ratings				Certifications	Environmental Rating	Wiring Capacity		Wiring Connection	Catalog Page
			Max VAC	Amperage	Current Interruption	HP@Max Voltage			Min / Max			
DSDC1	Polyester	2P+G	250	20	NO	-	cCSAus	Type 4X	14 awg	8 awg	Screw	224
DSDC3	Polyester	2P+G	250	30	NO	-	cCSAus	Type 4X	14 awg	4 awg	Screw	224
DSDC6	Metal or Poly	2P+G	250	60	NO	-	cCSAus	Type 4X	14 awg	4 awg	Screw	224
DSDC9	Metal	2P+G	250	100	NO	-	cCSAus	Type 4X	4 awg	2/0 awg	Screw	224
DSDC2	Metal	2P+G	250	200	NO	-	cCSAus	Type 4X	4 awg	4/0 awg	Screw	224

International Configurations & Ratings												
Product Type	Housing Material	Maximum Number of Contacts	Electrical Ratings				Certifications	Environmental Rating	Wiring Capacity		Wiring Connection	Catalog Page
			Max VAC	Amperage	Current Interruption	HP@Max Voltage			Min / Max			
DXN1	Polyester	3P+N+G	550	20	YES	-	ATEX, IECEx	IP66/IP67	16 awg	10 awg	Screw	190
DXN3	Polyester	3P+N+G	750	32	YES	-	ATEX, IECEx	IP66/IP67	14 awg	6 awg	Screw	192
DXN3	Polyester	3P+N+G + 2 aux	550	32	YES	-	ATEX, IECEx	IP66/IP67	14 awg	6 awg	Screw	192
DXN6	Polyester	3P+N+G	750	63	YES	-	ATEX, IECEx	IP66/IP67	10 awg	4 awg	Screw	194
DXN6	Polyester	3P+N+G + 2 aux	550	63	YES	-	ATEX, IECEx	IP66/IP67	10 awg	4 awg	Screw	194
DXA1	Metal	3P+N+G	550	20	YES	-	ATEX, IECEx	IP66/IP67	16 awg	10 awg	Screw	200
DX1	Aluminum	3P+N+G	750	20	YES	-	ATEX, IECEx	IP65	14 awg	8 awg	Screw	230
DX3	Aluminum	3P+N+G	750	32	YES	-	ATEX, IECEx	IP65	14 awg	8 awg	Screw	231
DX6	Aluminum	3P+N+G	750	63	YES	-	ATEX, IECEx	IP65/IP66	6 awg	1/0 awg	Screw	232
DX9	Aluminum	3P+N+G	750	125	YES	-	ATEX, IECEx	IP65/IP66	1/0 awg	2/0 awg	Screw	233
PXN12c	Metal	11P+G	220	10	NO	-	ATEX, IECEx	IP65/IP66	16 awg	14 awg	Solder/Crimp	239
DXN25c	Metal	24P+G	440	10	NO	-	ATEX, IECEx	IP66/IP67	16 awg	14 awg	Solder/Crimp	241
DXN37c	Metal	36P+G	220	10	NO	-	ATEX, IECEx	IP66/IP67	16 awg	14 awg	Solder/Crimp	241
SPeX	Polyester	1	1000	680	NO	-	ATEX, IECEx	IP66	2/0 awg	750mcm	Lug	244

DXN

Hazardous Location plug and receptacle



Main Advantages

- ▶ Easy to handle due to compact, lightweight design
- ▶ Available in in-line and wall/panel mounted configurations
- ▶ CSA, ATEX and IECEx certified for use in Zones 1 and 2 (gas) and Zones 21 and 22 (dust)



Watch the DXN
video and other
product videos at
meltric.com/video

- | | | | |
|----------------------------|--------|--------------|--------|
| ▶ Features & Ratings | p. 187 | ▶ DXN30 | p. 192 |
| ▶ Certifications & Testing | p. 188 | ▶ DXN60 | p. 194 |
| ▶ Operation | p. 189 | ▶ Dimensions | p. 196 |
| ▶ DXN20 | p. 190 | | |

PRODUCT FEATURES



Pushbutton Pawl/OFF Button

Provides quick, safe and easy current interruption.

Silver-Nickel Contacts

Silver-nickel contact material provides superior conductivity, durability and corrosion resistance.

Hazardous Location Termination Areas

Includes enhanced creepage and clearance distances and specially designed terminals to ensure perfect and permanent clamping.

Casing

Self-extinguishing, non-static, material provides outstanding resistance to mechanical abuse and chemicals.

Lid

When closed, the lid maintains IP66/IP67 protection for the receptacle after removal of the plug.

Spring-Loaded Butt-Style Contacts

Ensures optimal contact force and superior electrical performance over thousands of operations.

Arc Isolation Chamber

Minimizes gas/dust volume present during arcing, withstands internal pressure due to ignition of it and isolates the ignition from the outside environment.

Arc-Extinguishing Flame Path

Dissipates internal pressure created during arcing while also preventing any associated ignition sources from reaching the surrounding atmosphere.

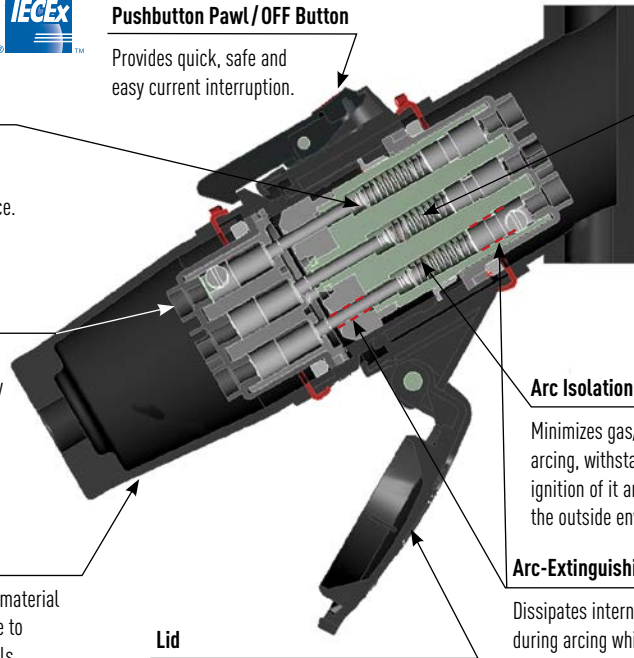

Operating Instructions



To connect, align the red dots, push the plug partially in, then turn clockwise slightly to line up the latch with the catch.



Push the plug fully home until it is held in place by the latch. The circuit is now closed.

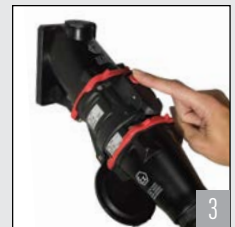

To disconnect, depress the latch and pull the plug simultaneously. This breaks the circuit. The plug contacts are now dead.

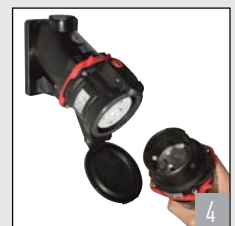

Rotate 30° counterclockwise and then withdraw the plug. The safety shutter prevents access to live parts.

General Ratings

Amperage	20 to 60A
Voltage	600 VAC
Frequency	50-400 Hz
Horsepower	1/2 to 20 hp
Environmental	IP66/IP67
Temperature	min -40°F/max 140°F

* DXN30 and DXN60 devices are 550VAC if ordered with optional auxiliary contacts.

Hazardous Location Listings (CSA or ATEX)

CSA	ATEX
Ex de IIC T*Gb	II 2 G/D
Ex tb IIIC T*Db	Ex de IIC T*Gb
	Ex tb IIIC T*Db
Class I Zone I AEx de IIC T*Gb	
Zone 21 AEx tD T*Db	
Class I Division 2 Gr A,B,C,D	
Class II Division 2 Gr E,F,G	

* See temperature tables in product sections.
See following page for additional ratings detail.

Plug & Receptacle Listings (CSA or ATEX)

Category	CSA	IEC
Plugs and Receptacles	C22.2 No. 182.1	60309-1

CE ratings available upon request.

Highlighted Feature

Dead Front



The dead front on the DXN receptacle provides protection from accidental tool and wire insertion.

HAZARDOUS LOCATION

DXN Certifications

Hazardous Duty Certification (example)

DXN's are offered with CSA or ATEX certifications for use in hazardous locations.

CSA

$-40^{\circ}\text{C} \leq \text{Ta} \leq +60^{\circ}\text{C}$

Class I Zone 1 AEx de IIC T5, Gb

Zone 21, AEx tD T90°C Db

Class I Division 2 Gr A,B,C,D

Class I – Indicates suitability for use in applications where flammable Gases, Vapors, or Mists may be present.

Zone I – Indicates suitability for use in applications where an explosive environment is likely to occur in the air in sufficient quantities to produce explosive or ignitable mixtures under normal operating conditions.

Division 2 – Indicates suitability for use where exposure to the hazard occurs under abnormal conditions.

GR A,B,C,D – Indicates suitability for use in areas that may contain Acetylene, Hydrogen, Ethylene, or Propane.

Class II Division 2 Gr E,F,G

Class II – Indicates suitability for use in applications where explosive dust atmosphere may occur.

Division 2 – Indicates suitability for use where hazard exposure occurs under abnormal conditions.

GR E,F,G – Indicates suitability for use in areas where Magnesium, Coal or Grain dust may occur.



CSA certification based on IEC 60079-0, 60079-1, 60079-7

ATEX and IECEx

II 2 G/D Ex de IIC T* Gb

Ex tb IIIC T* Db

$-40^{\circ}\text{C} \leq \text{Ta} \leq +60^{\circ}\text{C}$ T5 T90°C

$-40^{\circ}\text{C} \leq \text{Ta} \leq +40^{\circ}\text{C}$ T6 T70°C



II – Indicates suitability for installation in surface applications (as opposed to underground mine applications).

2 – Indicates suitability for use where a high level of protection is required and where the presence of an explosive atmosphere is likely to occur occasionally during normal operation (Zone 1 and Zone 21 environments).

G/D – Indicates suitability for installation in areas that may contain flammable gases, vapors/mists, or dusts.

T90°C* – Indicates a maximum surface temperature of the product of 90°C, at -40°C to 60°C ambient.

Ex de – Indicates that explosion protection is provided with (e) increased safety in the conductor termination area, and (d) flame proof chambers for making and breaking the current that can withstand the pressure of internal ignition and that prevent arcs, flame or other ignition events from being communicated to the surrounding atmosphere.

IIC – Indicates suitability for installation in areas where exposure to any type of gas, including the most dangerous subdivision C gases may occur.

T6* – Temperature class – the maximum product surface temperature is 185°F (85°C) for ambient temperature of 104°F (40°).

ATEX certification was performed by LCIE.

* Temperature ratings vary depending on product and ambient temperature. See specific product section for temperature ratings.

Electrical Performance Testing

Model	Key Performance Tests Passed				Temperature Rise (max)	Dielectric Test
	Mechanical Endurance	Electrical Endurance ¹	Overload Testing ²			
DXN20	-	5000 Operations	50 Operations	30°C	2 x V (rated) + 1000V	
DXN30	1000 Cycles	1000 Operations	50 Operations	30°C	2 x V (rated) + 1000V	
DXN60	1000 Cycles	1000 Operations	50 Operations	30°C	2 x V (rated) + 1000V	

¹ @ 100% of rated current and voltage and 0.6 power factor

² @125% of rated current, 110% of rated voltage, & 0.6 power factor

DXN Operation

Arcing is a natural occurrence when electrical contacts make and break under load. The purpose of a hazardous duty product is to prevent arcing from igniting hazardous gases or dusts present in the atmosphere into an explosion that may cause personal injury or damage to facilities and equipment. The DXN accomplishes this with specially designed flame-proof arc chambers.

The arc chambers are sized to minimize the amount of atmospheric gas or air/dust mixture that may ignite during arcing and are built to contain this internal mini-explosion and withstand the pressure that it generates. The length and width of the flame-proof pathways are very precisely designed to provide for the effective dissipation of the pressure, while also ensuring that the arcing and internal ignitions of gases or air/dust mixture in the arc chamber are totally isolated from the surrounding atmosphere.

- 1 When the plug and receptacle are connected, the flameproof arc chamber is completed with pressure relief/arc extinguishing pathways between the outer diameter of the plug contact and its associated contact hole in the safety shutter and between the main interior component and receptacle contact base.
- 2 DXN's are current interrupting rated devices. They can safely make and break under full load and also during moderate overload situations. During the making or breaking of the contacts, the arc chamber completely contains any ignitions of gas or dust due to arcing and the flame-proof pathways dissipate the pressure.
- 3 As the plug is being inserted or removed, the flame-proof arc chamber and pathways are maintained. This ensures continuous hazardous duty protection and the safety of the user.
- 4 When the plug and receptacle are disconnected, the receptacle maintains a flame-proof chamber. In this case, the flame-proof pathway exists between the safety shutter and the main interior component. The shutter also prevents access to live parts, providing users with the safety of a dead front. The plug must be inserted into the safety shutter and be rotated in order to access the receptacle contacts.

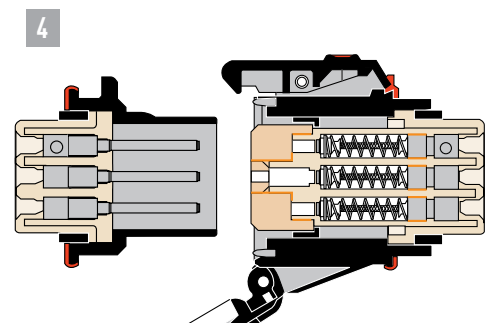
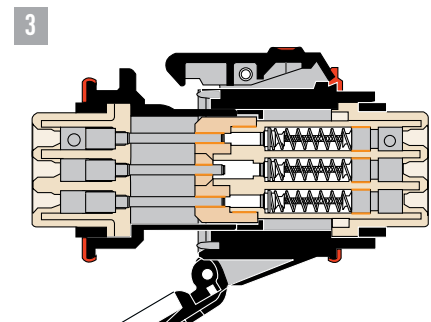
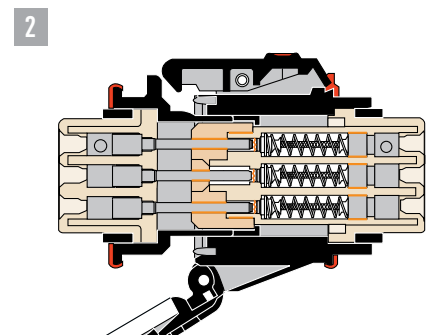
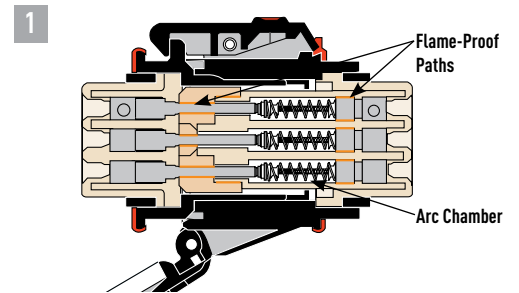

DXN20 Hazardous Location Plugs & Receptacles – 20A

Devices rated for hazardous locations are not returnable.

cCSAus Certifications DXN20

- Max Amperage & Voltage**
20A, 600 VAC, 60 Hz
- Current Interruption Capability**
For current interrupting (AC)
- Horsepower Ratings**

120V	1Ø	1/2 hp
240V	3Ø	2 hp
480V	3Ø	5 hp
600V	3Ø	5 hp
- Short Circuit Rating**
25kA Close & Withstand
Testing was performed with RK1 30A fuse sized at 400% of the highest full load motor ampacity associated with the devices hp rating.
Note: Consult NEC for Short Circuit limits.
- Environmental Ratings**
Type IP66/IP67
- Wiring Capacity**
Min 16 AWG Max 10 AWG
* Based on THHN wire sizes
- Applicable Standards**
CSA C22.2 No. 182.1
- Hazardous Location Ratings**

-40°C ≤ Ta ≤ +60°C
Ex de IIC T5 Gb Ex tb IIIC T90°C Db
Class I Zone 1 AEx de IIC T5 Gb
Zone 21 AEx td T90°C Db
Class I Div 2 Gr A, B, C, D
Class II Div 2 Gr E, F, G
cCSAus 00.1144.106X

Receptacle (female)



Standard DXN20 lid opens to 120°

Inlet (male)



! Receptacles & Inlets must be mounted to a DXN handle, angle or wall box

North American cCSAus Configurations

Voltage	Polarity	Part # Poly	Part # Poly
120V	1P+N+G	22-14165	22-18165
125V	1P+N+G	22-14075	22-18075
208V	2P+G	22-14162	22-18162
208V	3P+G	22-14163	22-18163
208V	3P+N+G	22-14167	22-18167
250V	2P+G	22-14072	22-18072
250V	3P+G	22-14073	22-18073
250V	2P+N+G	22-14076	22-18076
277V	1P+N+G	22-14045	22-18045
480V	2P+G	22-14042	22-18042
480V	3P+G	22-14043	22-18043
480V	3P+N+G	22-14047	22-18047
600V	2P+G	22-14142	22-18142
600V	3P+G	22-14143	22-18143
600V	3P+N+G	22-14147	22-18147

Receptacle Options	Suffix #	Inlet Options	Suffix #
Padlock Pawl	Recept # - 843	With No Lockout Hole	Inlet # - A155
Metal Pawl on Poly Receptacle	Recept # - 924		
Closed Lid Configuration	Recept # - R		
180° Lid Opening	Recept # - 180		

ATEX/IECEx Certifications DXN1

- Current** 20A
- Environmental** IP66/IP67
- Ambient Temp** -40°C to +60°C
- Hazardous Location Ratings**
ATEX/IECEx Zones 1 & 2, 21 & 22

MARECHAL ELECTRIC MAROMME
Ex II 2 G/D Ex de IIC T*Gb
Ex tb IIIC T*Db

-40 °C ≤ TA ≤ +60 °C T5 T90 °C
-40 °C ≤ TA ≤ +40 °C T6 T70 °C
IECEx LCI 09.0005X / LCIE 99 ATEX 6027X

See MELTRIC's International Catalog (online) for additional product information.

Receptacle

Inlet

IEC/CE Configurations (ATEX/IECEx)

Voltage	Polarity	Part # Poly	Part # Poly
20 - 24 V	2P	25-1408A	25-1808A
190 - 230 V	3P+E	25-14033	25-18033
220 - 250 V	1P+N+E	25-14015	25-18015
380 - 440 V	3P+E	25-14013	25-18013
380 - 440 V	3P+N+E	25-14017	25-18017
480 - 500 V	3P+E	25-14093	25-18093
480 - 500 V	3P+N+E	25-14097	25-18097

Receptacle Options	Suffix #	Receptacle Options	Suffix #
Padlock Pawl w/shaft for 3 locks	Recept # + 844	Self-returning Lid	Recept # + R
180° Lid Opening	Recept # + 10	180° Opening & Self-returning Lid	Recept # + 18

INSTALLATION ACCESSORIES – SIZE 1

Accessories rated for hazardous locations are not returnable.

HANDLES

POLY HANDLE w/NPT		Part #	
	1/2"	22-1A013-12	For use in Class I or II Division 2 or Class 1 Zone 1 or Zone 21 depending on fitting used. Fitting manufactured by others.
	3/4"	22-1A013-34	

POLY HANDLE w/CORD GRIP w/Cable Range		Part #	
	.24 - .47"	251P0BPA	For use in Class I or II Division 2, Class I Zone 1 or Zone 21 -20°C ≤ Ta ≤ +85°C
	.39 - .55"	251P0BPB	
	.35 - .63"	251P0CPD	
	.51 - .71"	251P0CPC	

ANGLES

POLY ANGLE		Part #
	30°	22-1A057

HANDLES

POLY HANDLE w/POLY Cable Gland		Part #	
	7 - 14 mm	25-1A753	For use in Zones 1 & 2 Zones 21 & 22
	10 - 18 mm	25-1A253-25P	
	17 - 24 mm	25-1A253-32P	

POLY HANDLE w/METAL Cable Gland		Part #	
	8 - 10 mm	25-1A253-20M	With Earth continuity
	12 - 14 mm	25-1A253-25M	
	18 - 24 mm	25-1A253-32M	

ANGLES

POLY ANGLE		Part #
	30°	25-1A057

POLY ANGLE		Part #	
	70°	25-1A757	For panel mounting. Not a replacement part for 70° wall box.

BOXES

POLY WALL BOX w/NPT		Part #	
	30° NPT	22-1A023-12-T	NPT Thread on top
	30°	22-1A023-34-T	* Interior volume with receptacle installed.

POLY WALL BOX w/NPT		Part #	
	30°	22-1A023-12-B	NPT Thread on bottom
	30°	22-1A023-34-B	* Interior volume with receptacle installed.

POLY ANGLE WITH LARGER METAL WALL BOX w/NPT		Part #	
	70°	22-1A058-12	NPT is drilled on top of metal box as standard. For NPT on side only, add an "L" suffix. To switch from top to bottom or left to right the box can be rotated.
	70°	22-1A058-34	
	70°	22-1A058-1	
	70°	22-1A058-114	
	70°	22-1A058-112	

NPT on top or bottom (if rotated). For other NPT configurations, contact customer service.

* Interior volume with receptacle installed.

MISCELLANEOUS ACCESSORIES

FINGER DRAWPLATES		Part #	
		61-1A346	Set of Two (2) Recommended for cord to cord assembly applications, for easier connector closure.

PROTECTIVE CAP		Part #	
		22-1A426	For Male Devices Only.

RECEPTACLE LOCKING PIN		Part #	
		LP-843	Requires Padlockable Pawl option (-843) on receptacle.

BOXES

POLY WALL BOX		Part #
	30°	25-1AB53
	30°	25-1AB53-25P

POLY WALL BOX 120x120 w/o TERMINAL BLOCKS		Part #	
	70°	25-1AB88-20P	With earth continuity + 1 hole with a poly cable gland.
	70°	25-1AB88-25P	
	70°	25-1AB88-32P	

POLY WALL BOX 120x120 w/4mm² TERMINAL BLOCKS		Part #	
	70°	25-1A088-20P	With 2 holes (1 with a cable gland + 1 with a stopping plug), with 8+2E 4 mm² terminals blocks + 2,5 mm² wires, wiring 2,5-4 mm². For loop in loop out wiring.
	70°	25-1A088-25P	

New 70° angle will replace the 30° angle (shown) on poly wall box in 2018.

-40°C ≤ Ta ≤ +60°C T5 T90°C
-40°C ≤ Ta ≤ +40°C T6 T70°C

DXN30 Hazardous Location Plugs & Receptacles – 30A

Devices rated for hazardous locations are not returnable.

cCSAus Certifications DXN30

- Max Amperage & Voltage**
30A, 600 VAC, 60 Hz
- Current Interruption Capability**
For current interrupting (AC)
- Horsepower Ratings**

120V	1Ø	1 hp
240V	3Ø	5 hp
480V	3Ø	10 hp
600V	3Ø	15 hp
- Short Circuit Rating**
25kA Close & Withstand
Testing was performed with RK1 70A fuse sized at 400% of the highest full load motor ampacity associated with the devices hp rating.
Note: Consult NEC for Short Circuit limits.
- Environmental Ratings**
Type IP66/IP67
- Wiring Capacity**
Min 14 AWG Max 6 AWG
Aux Contacts - Max 10 AWG
* Based on THHN wire sizes
- Applicable Standards**
CSA C22.2 No. 182.1
- Hazardous Location Ratings**

-40°C ≤ Ta ≤ +60°C
Ex de IIC T5 Gb Ex tb IIIC T77°C Db
Class I Zone 1 AEx de IIC T5 Gb
Zone 21 AEx td T77°C Db
Class II Div 2 Gr A, B, C, D
Class II Div 2 Gr E, F, G
cCSAus 00.1144106X

Receptacle (female)



Standard DXN30 lid opens to 120°

Inlet (male)



! Receptacles & Inlets must be mounted to a DXN handle, angle or wall box

North American cCSAus Configurations

Voltage	Polarity	Part # Poly	Part # Poly
120V	1P+N+G	22-34165	22-38165
125V	1P+N+G	22-34075	22-38075
208V	2P+G	22-34162	22-38162
208V	3P+G	22-34163	22-38163
208V	3P+N+G	22-34167	22-38167
250V	2P+G	22-34072	22-38072
250V	3P+G	22-34073	22-38073
250V	2P+N+G	22-34076	22-38076
277V	1P+N+G	22-34045	22-38045
480V	2P+G	22-34042	22-38042
480V	3P+G	22-34043	22-38043
480V	3P+N+G	22-34047	22-38047
600V	2P+G	22-34142	22-38142
600V	3P+G	22-34143	22-38143
600V	3P+N+G	22-34147	22-38147

Receptacle Options	Suffix #	Inlet Options	Suffix #
With 2 Auxiliary/Pilot Contacts*	Recept # - 972	With 2 Auxiliary/Pilot Contacts*	Inlet # - 972
Padlock Pawl	Recept # - 843	With No Lockout Hole	Inlet # - A155
Metal Pawl on Poly Receptacle	Recept # - 924	* Not available with 600V devices, use -972-S74 for 550 VAC	
Closed Lid Configuration	Recept # - R		
180° Lid Opening	Recept # - 180		

ATEX/IECEx Certifications DXN30

- Current** 32A
- Environmental** IP66/IP67
- Ambient Temp** -40°C to +60°C
- Hazardous Location Ratings**
ATEX/IECEx Zones 1 & 2, 21 & 22

MARECHAL ELECTRIC MAROMME
Ex de IIC T*Gb
Ex tb IIIC T*Db
-40 °C ≤ Ta ≤ +60 °C T5 T77 °C
-40 °C ≤ Ta ≤ +40 °C T6 T57 °C
IECEx LCI 09.0006X / LCIE 05 ATEX 6149

See MELTRIC's International Catalog (online) for additional product information.

Receptacle

Inlet

IEC/CE Configurations (ATEX/IECEx)

Voltage	Polarity	Part # Poly	Part # Poly
20 - 24 V	2P	25-3408A	25-3808A
190 - 230 V	3P+E	25-34033	25-38033
220 - 250 V	1P+N+E	25-34015	25-38015
380 - 440 V	3P+E	25-34013	25-38013
380 - 440 V	3P+N+E	25-34017	25-38017
480 - 500 V	3P+E	25-34093	25-38093
480 - 500 V	3P+N+E	25-34097	25-38097

Receptacle Options	Suffix #	Receptacle Options	Suffix #
Padlock Pawl w/shaft for 3 locks	Recept # + 844	Self-returning Lid	Recept # + R
180° Lid Opening	Recept # + 10	180° Opening & Self-returning Lid	Recept # + 18
With 2 Auxiliary/Pilot Contacts*	Recept # + 972 Inlet # + 972		

INSTALLATION ACCESSORIES – SIZE 2

Accessories rated for hazardous locations are not returnable.

HANDLES

POLY HANDLE w/NPT		Part #	
	3/4"	22-3A013-34	For use in Class I or II Division 2 or Class 1 Zone 1 or Zone 21 depending on fitting used. Fitting manufactured by others.
	1"	22-3A013-1	

POLY HANDLE w/CORD GRIP w/Cable Range			
	.35 - .63"	252P0CPD	For use in Class I or II Division 2, Class I Zone 1 or Zone 21. -20°C ≤ Ta ≤ +85°C
	.51 - .71"	252P0CPC	
	.51 - .79"	252P0DPF	
	.71 - .98"	252P0DPE	

ANGLES

POLY ANGLE			
	30°	22-3A027	

HANDLES

POLY HANDLE w/POLY Cable Gland		Part #	
	7 - 14 mm	25-3A753	For use in Zones 1 & 2 Zones 21 & 22
	10 - 18 mm	25-3A783	
	17 - 24 mm	25-3A253-32P	
	17 - 31 mm	25-3A253-40P	

POLY HANDLE w/METAL Cable Gland			
	8 - 10 mm	25-3A253-20M	With Earth continuity
	12 - 14 mm	25-3A253-25M	
	18 - 24 mm	25-3A253-32M	

ANGLES

POLY ANGLE			
	30°	25-3A027	

POLY ANGLE			
	70°	25-3A757	For panel mounting. Not a replacement part for 70° wall box.

BOXES

POLY WALL BOX w/NPT		Part #	
	30° 3/4"	22-3A023-34-T	NPT Thread on top. * Interior volume with receptacle installed.

POLY WALL BOX w/NPT		Part #	
	30° 3/4"	22-3A023-34-B	NPT Thread on bottom. * Interior volume with receptacle installed.

POLY ANGLE WITH LARGER METAL WALL BOX w/NPT			
	70° 1/2"	22-3A058-12	NPT is drilled on top of metal box as standard. For NPT on side only, add an "L" suffix. To switch from top to bottom or left to right the box can be rotated. * Interior volume with receptacle installed.
	70° 3/4"	22-3A058-34	
	70° 1"	22-3A058-1	
	70° 1 1/4"	22-3A058-114	
	70° 1 1/2"	22-3A058-112	

NPT on top or bottom (if rotated). For other NPT configurations, contact customer service.

MISCELLANEOUS ACCESSORIES

FINGER DRAWPLATES			
	61-3A346	Set of Two (2)	Recommended for cord to cord assembly applications, for easier connector closure.

PROTECTIVE CAP			
	22-3A426	For Male Devices Only.	

RECEPTACLE LOCKING PIN			
	LP-843	Requires Padlockable Pawl option (-843) on receptacle.	

BOXES

POLY WALL BOX		Part #	
	30° 7 - 14 mm	25-3AB53	
	30° 10 - 18 mm	25-3AB53-25P	

POLY WALL BOX 160x160 w/o TERMINAL BLOCKS			
	70° 7 - 14 mm	25-3AB88-20P	With earth continuity + 1 hole with a poly cable gland.
	70° 10 - 18 mm	25-3AB88-25P	
	70° 17 - 24 mm	25-3AB88-32P	

POLY WALL BOX 160x160 w/10mm ² TERMINAL BLOCKS			
	70° 7 - 14 mm	25-3A088-20P	With 2 holes (1 with a cable gland + 1 with a stopping plug), with 8+2E 10 mm ² terminals blocks + 6 mm ² wires, wiring 6-10 mm ² . For loop in loop out wiring. -40°C ≤ Ta ≤ +60°C T5 T77°C -40°C ≤ Ta ≤ +40°C T6 T57°C
	70° 10 - 18 mm	25-3A088-25P	
	70° 17 - 24 mm	25-3A088-32P	

New 70° angle will replace the 30° angle (shown) on poly wall box in 2018.

HAZARDOUS LOCATION

DXN60 Hazardous Location Plugs & Receptacles – 60A

Devices rated for hazardous locations are not returnable.

cCSAus Certifications DXN60

- Max Amperage & Voltage**
60A, 600 VAC, 60 Hz
- Current Interruption Capability**
For current interrupting (AC)
- Horsepower Ratings**

120V	1Ø	2 hp
240V	3Ø	7.5 hp
480V	3Ø	20 hp
600V	3Ø	20 hp
- Short Circuit Rating**
25kA Close & Withstand
Testing was performed with RK1 100A fuse sized at 400% of the highest full load motor ampacity associated with the devices hp rating.
Note: Consult NEC for Short Circuit limits.
- Environmental Ratings**
Type IP66/IP67
- Wiring Capacity**
Min 10 AWG Max 4 AWG
Aux Contacts - Max 10 AWG
* Based on THHN wire sizes
- Applicable Standards**
CSA C22.2 No. 182.1
- Hazardous Location Ratings**

-40°C ≤ Ta ≤ +60°C
Ex de IIC T4 Gb Ex tb IIIC T100°C Db
Class I Zone 1 AEx de IIC T4 Gb
Zone 21 AEx td T100°C Db
Class I Div 2 Gr A,B,C,D
Class II Div 2 Gr E,F,G
cCSAus 00.1144106X

Receptacle (female)



Standard DXN60 lid opens to 120°

Inlet (male)



! Receptacles & Inlets must be mounted to a DXN handle, angle or wall box

North American cCSAus Configurations

Voltage	Polarity	Part # Poly	Part # Poly
120V	1P+N+G	22-64165	22-68165
125V	1P+N+G	22-64075	22-68075
208V	2P+G	22-64162	22-68162
208V	3P+G	22-64163	22-68163
208V	3P+N+G	22-64167	22-68167
250V	2P+G	22-64072	22-68072
250V	3P+G	22-64073	22-68073
250V	2P+N+G	22-64076	22-68076
277V	1P+N+G	22-64045	22-68045
480V	2P+G	22-64042	22-68042
480V	3P+G	22-64043	22-68043
480V	3P+N+G	22-64047	22-68047
600V	2P+G	22-64142	22-68142
600V	3P+G	22-64143	22-68143
600V	3P+N+G	22-64147	22-68147

Receptacle Options	Suffix #	Inlet Options	Suffix #
With 2 Auxiliary/Pilot Contacts*	Recept # - 972	With 2 Auxiliary/Pilot Contacts*	Inlet # - 972
Padlock Pawl	Recept # - 843	With No Lockout Hole	Inlet # - A155
Metal Pawl on Poly Receptacle	Recept # - 924	* Not available with 600V devices, use -972-S74 for 550 VAC	
Closed Lid Configuration	Recept # - R		
180° Lid Opening	Recept # - 180		

ATEX/IECEx Certifications DXN6

- Current** 63A
- Environmental** IP66/IP67
- Ambient Temp** -40°C to +60°C
- Hazardous Location Ratings**
ATEX/IECEx Zones 1 & 2, 21 & 22

MARECHAL ELECTRIC MAROMME
Ex de IIC T*Gb
Ex tb IIIC T*Db
-40 °C ≤ Ta ≤ +60 °C T4 T107 °C
-40 °C ≤ Ta ≤ +40 °C T5 T87 °C
IECEx LCI 09.0007 / LCIE 05 ATEX 6150

See MELTRIC's International Catalog (online) for additional product information.

Receptacle

Inlet

IEC/CE Configurations (ATEX/IECEx)

Voltage	Polarity	Part # Poly	Part # Poly
20 - 24 V	2P	25-6408A	25-6808A
190 - 230 V	3P+E	25-64033	25-68033
220 - 250 V	1P+N+E	25-64015	25-68015
380 - 440 V	3P+E	25-64013	25-68013
380 - 440 V	3P+N+E	25-64017	25-68017
480 - 500 V	3P+E	25-64093	25-68093
480 - 500 V	3P+N+E	25-64097	25-68097

Receptacle Options	Suffix #	Receptacle Options	Suffix #
Padlock Pawl w/shaft for 3 locks	Recept # + 844	Self-returning Lid	Recept # + R
180° Lid Opening	Recept # + 10	180° Opening & Self-returning Lid	Recept # + 18
With 2 Auxiliary/Pilot Contacts*	Recept # + 972 Inlet # + 972		

INSTALLATION ACCESSORIES – SIZE 3

Accessories rated for hazardous locations are not returnable.

HANDLES

POLY HANDLE w/NPT		Part #	
	1"	22-6A013-1	For use in Class I or II Division 2 or Class 1 Zone 1 or Zone 21 depending on fitting used. Fitting manufactured by others.

POLY HANDLE w/CORD GRIP w/Cable Range			
	.51 - .79"	253P0DPF	For use in Class I or II Division 2, Class I Zone 1 or Zone 21.
	.71 - .98"	253P0DPE	

-20°C ≤ Ta ≤ +85°C

ANGLES

POLY ANGLE			
	30°	22-6A027	

HANDLES

POLY HANDLE w/POLY Cable Gland		Part #	
	7 - 14 mm	25-6A253-20P	For use in Zones 1 & 2 Zones 21 & 22.
	10 - 18 mm	25-6A753	
	17 - 24 mm	25-6A253-32P	
	17 - 31 mm	25-6A253-40P	

POLY HANDLE w/METAL Cable Gland			
	8 - 10 mm	25-6A253-20M	With Earth continuity.
	12 - 14 mm	25-6A253-25M	
	18 - 24 mm	25-6A253-32M	

ANGLES

POLY ANGLE			
	30°	25-6A027	

POLY ANGLE			
	70°	25-6A757	For panel mounting. Not a replacement part for 70° wall box.

BOXES

POLY WALL BOX w/NPT		Part #	
	30° 1"	22-6A023-1-T	NPT Thread on top. * Interior volume with receptacle installed.

POLY WALL BOX w/NPT		Part #	
	30° 1"	22-6A023-1-B	NPT Thread on bottom. * Interior volume with receptacle installed.

POLY ANGLE WITH LARGER METAL WALL BOX w/NPT			
	70° 1/2"	22-6A058-12	NPT is drilled on top of metal box as standard. For NPT on side only, add an "L" suffix. To switch from top to bottom or left to right the box can be rotated. * Interior volume with receptacle installed.
	70° 3/4"	22-6A058-34	
	70° 1"	22-6A058-1	
	70° 1 1/4"	22-6A058-114	
	70° 1 1/2"	22-6A058-112	

NPT on top or bottom (if rotated). For other NPT configurations, contact customer service.

MISCELLANEOUS ACCESSORIES

FINGER DRAWPLATES			
	61-6A346	Set of Two (2)	Recommended for cord to cord assembly applications, for easier connector closure.

PROTECTIVE CAP			
	22-6A426	For Male Devices Only.	

RECEPTACLE LOCKING PIN			
	LP-843	Requires Padlockable Pawl option (-843) on receptacle.	

BOXES

POLY WALL BOX	Ex Cable Gland	Part #	
	30° M25	25-6AB53	

POLY WALL BOX 160x160 w/o TERMINAL BLOCKS			
	70° 7 - 14 mm	25-6AB88-20P	With earth continuity + 1 hole with a poly cable gland.
	70° 10 - 18 mm	25-6AB88-25P	
	70° 17 - 24 mm	25-6AB88-32P	

POLY WALL BOX 160x160 w/16mm ² TERMINAL BLOCKS			
	70° 7 - 14 mm	25-6A088-20P	With 2 holes (1 w/ cable gland + 1 w/ stopping plug), with 8x2E 16 mm ² terminals blocks + 16 mm ² wires, wiring 16 mm ² . For loop in loop out wiring.
	70° 10 - 18 mm	25-6A088-25P	
	70° 17 - 24 mm	25-6A088-32P	
	70° 17 - 31 mm	25-6A088-40P	

New 70° angle will replace the 30° angle (shown) on poly wall box in 2018.

-40°C ≤ Ta ≤ +55°C T4 T105°C
-40°C ≤ Ta ≤ +50°C T5 T95°C

DXN DIMENSIONS Inlet – Provided in inches

Dimensions are for reference only and may change depending on accessories used. For precise dimensions contact MELTRIC Engineering.

Plug

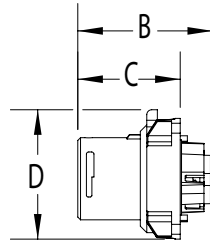
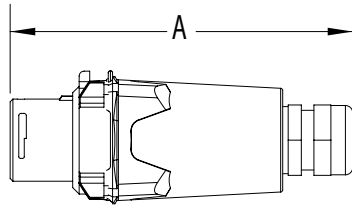

Inlet

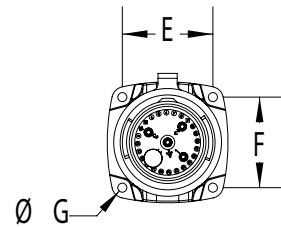

PRODUCT	A	B	C	D	E	F	ØG
DXN20	6.36	2.57	1.86	2.4	1.65	1.65	0.18
DXN30	6.47	3.03	1.97	2.83	1.89	1.89	0.19
DXN60	9.67	3.94	2.19	3.02	2.19	2.19	0.2

Connector

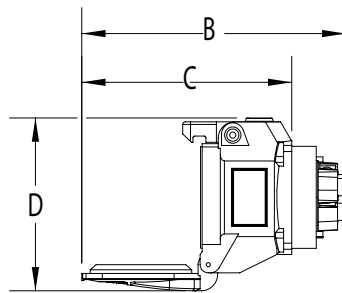
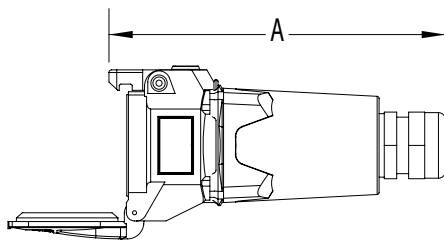

Receptacle

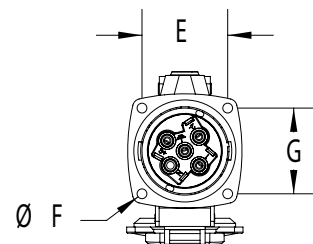

PRODUCT	A	B	C	D	E	ØF	G
DXN20	6.22	4.77	4.09	5.28	1.65	0.18	1.65
DXN30	7.17	5.49	4.29	7.05	1.89	0.20	1.89
DXN60	8.31	7.18	5.91	7.68	2.19	0.20	2.19

30° Angle/Receptacle/Plug

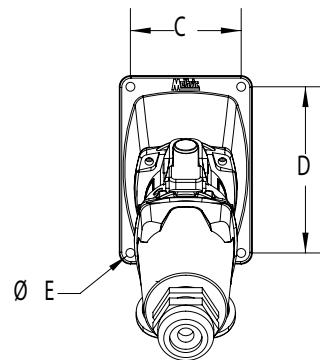
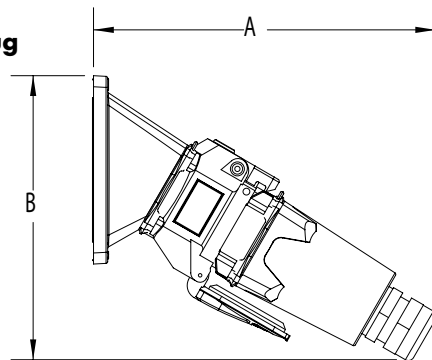

PRODUCT	A	B	C	D	ØE
DXN20	7.52	5.91	2.5	3.75	0.2
DXN30	8.07	6.57	2.5	3.75	0.2
DXN60	9.41	7.48	2.5	3.75	0.2



70° Wall Box/ Receptacle/Plug

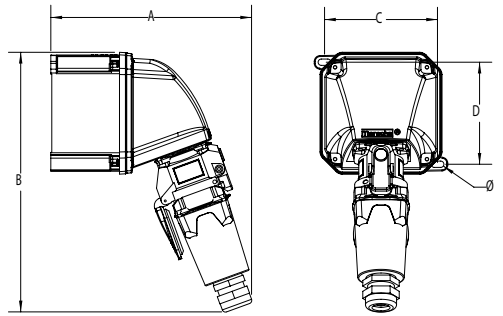

PRODUCT	A	B	C	D	øE
DXN20	8.17	10.57	4.6	4.15	0.26
DXN30	9.25	12.62	6.17	5.73	0.26
DXN60	11.88	13.39	6.17	5.73	0.26

Connector/Plug

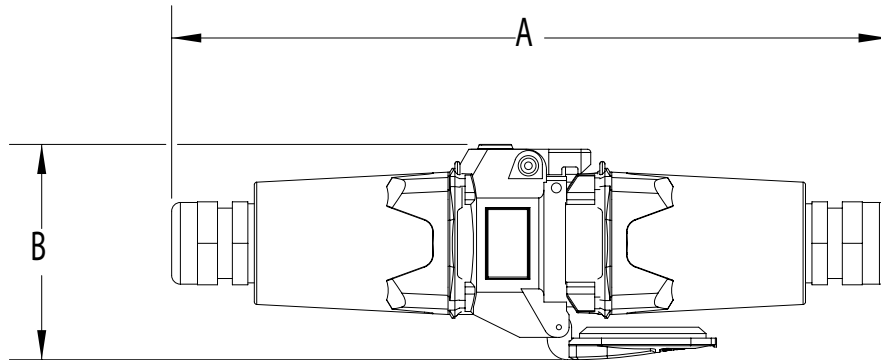

PRODUCT	A	B
DXN20	11.1	3.33
DXN30	12.59	4.08
DXN60	13.95	4.65



DXA1

Hazardous Location plug and receptacle

Main Advantages

- ▶ CSA & ATEX hazardous listings
- ▶ Robust metal casings withstand harsh environments
- ▶ Spring-loaded, butt-style contacts provide superior performance
- ▶ Dual pawls with locking feature for secure connections



- ▶ **Features & Ratings** p. 199
- ▶ **DXA1 20** p. 200

PRODUCT FEATURES



Locking Provision

For insertion of locking pin (or padlock) to prevent inadvertent disconnection.

Metal Casing

Provides excellent durability and protection.

Lid

Provides additional protection from harsh environments.

IP66/IP67 Watertightness

Environmental rating is achieved as soon as the plug is latched to the receptacle. There is no additional ring to tighten.

Silver-Nickel Contacts



Silver-nickel contact material provides superior conductivity, durability and corrosion resistance.



Spring Loaded Butt-Style Contacts

Ensures optimal contact force and superior electrical performance over thousands of operations.

Hazardous Location Listings (CSA or ATEX)

CSA 	ATEX 
Ex de IIC T*Gb	II 2 G D Ex de IIC T*Gb Ex tb IIIC T* Db
Ex tb IIIC T*Db	-55°C <Ta< 40°C T6 T68°C
Class I Zone I AEx de IIC T*Gb	-55°C <Ta< 60°C T5 T88 °C
Zone 21 AEx tD T*Db	LCIE 15 ATEX 3033 / IECEx LCIE 15.0030
Class I Division 2 Gr A,B,C,D	
Class II Division 2 Gr E,F,G	
-55°C <Ta< 40°C T6 T68°C	
-55°C <Ta< 60°C T5 T88 °C	

The DXA product line is similar to the DXN, but uses a larger casing made of aluminum and equipped with dual pawls for use in more abusive and colder environments.



Hazardous Location Plugs & Receptacles – 20A

Devices rated for hazardous locations are not returnable.

cCSAus Certifications

- Max Amperage & Voltage**
 20A, 600 VAC, 60 Hz
- Current Interruption Capacity**
 For current interrupting (AC)
- Horsepower Ratings**

120V	1Ø	1/2 hp
240V	3Ø	2 hp
480V	3Ø	5 hp
600V	3Ø	5 hp
- Short Circuit Rating**
 25kA Close & Withstand
 Testing was performed with RK1 30A fuse sized at 400% of the highest full load motor ampacity associated with the devices hp rating.
 Note: Consult NEC for Short Circuit limits.
- Environmental Ratings**
 IP66/IP67
- Temperature Range**
 Min -67°F / Max 140°F
- Wiring Capacity**
 Min 16 AWG Max 10 AWG
 * Based on THHN wire sizes
- Applicable Standards**
 CSA C22.2 No. 182.1
- Hazardous Location Ratings**

-55°C ≤ Ta ≤ +60°C
 Ex de IIC T5 Gb Ex tb IIIC T88°C Db
 Class I Zone1 AEx de IIC T5 Gb
 Zone 21 AEx tD T88°C Db
 Class I Div 2 Gr A,B,C,D
 Class II Div 2 Gr E,F,G
 cCSAus 00.114406X

XXX Suffix

XXX (Suffix #)	Threaded NPT
-12	1/2"
-34	3/4"

Receptacle Female



or

Inlet Male



North American Configurations

Voltage	Polarity	Part # Metal	Part # Metal
120V	1P+N+G	2814165	2818165
125V	1P+N+G	2814075	2818075
208V	2P+G	2814162	2818162
208V	3P+G	2814163	2818163
208V	3P+N+G	2814167	2818167
250V	2P+G	2814072	2818072
250V	3P+G	2814073	2818073
250V	2P+N+G	2814076	2818076
277V	1P+N+G	2814045	2818045
480V	2P+G	2814042	2818042
480V	3P+G	2814043	2818043
480V	3P+N+G	2814047	2818047
600V	2P+G	2814142	2818142
600V	3P+G	2814143	2818143
600V	3P+N+G	2814147	2818147

For international configurations (ATEX/IECEX) visit meltric.com/international-catalog or contact customer service at 800.433.7642.

Connector Female



or

Plug Male



North American Configurations

Voltage	Polarity	Part # Metal	Part # Metal
120V	1P+N+G	2813165XX	2811165XX
125V	1P+N+G	2813075XX	2811075XX
208V	2P+G	2813162XX	2811162XX
208V	3P+G	2813163XX	2811163XX
208V	3P+N+G	2813167XX	2811167XX
250V	2P+G	2813072XX	2811072XX
250V	3P+G	2813073XX	2811073XX
250V	2P+N+G	2813076XX	2811076XX
277V	1P+N+G	2813045XX	2811045XX
480V	2P+G	2813042XX	2811042XX
480V	3P+G	2813043XX	2811043XX
480V	3P+N+G	2813047XX	2811047XX
600V	2P+G	2813142XX	2811142XX
600V	3P+G	2813143XX	2811143XX
600V	3P+N+G	2813147XX	2811147XX

Cord grip not included. NPT sizes are determined by the cable diameter. Select hazardous cord grip from Cord Grip section, pg 179.

For international configurations (ATEX/IECEX) visit meltric.com/international-catalog or contact customer service at 800.433.7642.

Receptacle/30° Angle Inlet/30° Angle

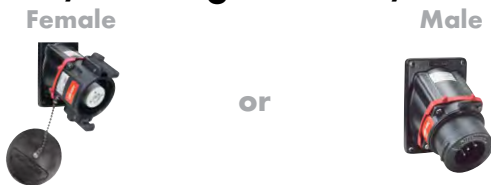

North American Configurations

Voltage	Polarity	Part # Metal	Part # Metal
120V	1P+N+G	2817165	2819165
125V	1P+N+G	2817075	2819075
208V	2P+G	2817162	2819162
208V	3P+G	2817163	2819163
208V	3P+N+G	2817167	2819167
250V	2P+G	2817072	2819072
250V	3P+G	2817073	2819073
250V	2P+N+G	2817076	2819076
277V	1P+N+G	2817045	2819045
480V	2P+G	2817042	2819042
480V	3P+G	2817043	2819043
480V	3P+N+G	2817047	2819047
600V	2P+G	2817142	2819142
600V	3P+G	2817143	2819143
600V	3P+N+G	2817147	2819147

For international configurations (ATEX/IECEX) visit meltric.com/international-catalog or contact customer service at 800.433.7642.

Receptacle/Wall Box Inlet/Wall Box

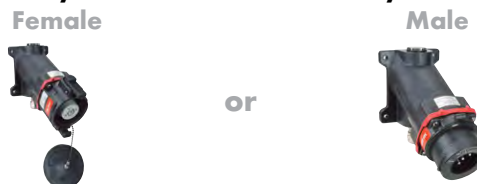



North American Configurations

Voltage	Polarity	Part # Metal	Part # Metal
120V	1P+N+G	2810165XXY	2816165XXY
125V	1P+N+G	2810075XXY	2816075XXY
208V	2P+G	2810162XXY	2816162XXY
208V	3P+G	2810163XXY	2816163XXY
208V	3P+N+G	2810167XXY	2816167XXY
250V	2P+G	2810072XXY	2816072XXY
250V	3P+G	2810073XXY	2816073XXY
250V	2P+N+G	2810076XXY	2816076XXY
277V	1P+N+G	2810045XXY	2816045XXY
480V	2P+G	2810042XXY	2816042XXY
480V	3P+G	2810043XXY	2816043XXY
480V	3P+N+G	2810047XXY	2816047XXY
600V	2P+G	2810142XXY	2816142XXY
600V	3P+G	2810143XXY	2816143XXY
600V	3P+N+G	2810147XXY	2816147XXY

For international configurations (ATEX/IECEX) visit meltric.com/international-catalog or contact customer service at 800.433.7642.

Accessories & Options

	Inlet Cap
Part #	28-1A426
	Receptacle Lockout Pin
Part #	LP-843
	Finger Drawplates
Part #	281A346

XXY Suffix

XXY (Suffix #)	Threaded NPT	Location
12T	1/2"	Top
12B	1/2"	Bottom
34T	1/2"	Top
34B	1/2"	Bottom

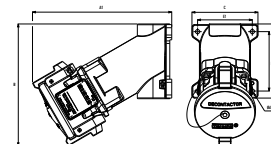

! Contact MELTRIC Engineering for DXA1 dimensions.

ZONE 2

Hazardous Location
rated plugs & receptacles



Main Advantages

- ▶ Featuring silver nickel butt-style contacts for maximum performance and durability
- ▶ Available in in-line and wall/panel mounted configurations
- ▶ Ideal for motor connections up to 75 hp



- ▶ Features & Ratings p. 203
- ▶ DSN/DS p. 204
- ▶ DR p. 216
- ▶ DSDC p. 224

PRODUCT FEATURES



General Ratings

Amperage	20 to 250A
Voltage	600 VAC
Frequency	60 Hz
Horsepower	2 to 100 hp
Environmental	Type 4X
Temperature	min -40°F/max 104°F

Hazardous Location Listings

Class I Division 2 Gr A,B,C,D, T6
Class I Zone 2, IIC

Plug & Receptacles Listings (CSA)

Category	CSA
Plugs and Receptacles	C22.2 No. 182.1-07
Electrical Equipment for Class I, Div 2 Locations	C22.2 No. 213-M1987

Highlighted Feature

Typical Device Labels

Meltric DS60
60A, 480VAC
20hp, TYPE 4X
1002001
36-64043
RECEPTACLE/CONNECTOR
Class I, Division 2, Groups ABCD, T6
Class I, Zone 2, IIC



DS and DSN plugs and receptacles are CSA horsepower rated for motor connections in hazardous locations. Not to be operated while energized.

Operating Instructions



Before connection, ensure that the circuit is deenergized. Align the red dots, push the plug partially in, then turn clockwise slightly to line up the latch with the catch.



Push the plug fully home until it is held in place by the latch. The circuit is now closed.



Listing Requirement: Tighten screw to lock the plug in the mated position.



Optional: Insert a 5/16" lock or locking pin to prevent disconnection or to lock the receptacle lid closed.

DS20 Hazardous Location Plugs & Receptacles – 20A

Devices rated for hazardous locations are not returnable.

UL US Ratings

- Voltage**
600 VAC
- Current Interruption Capability**
Not for current interrupting
- Horsepower Ratings**

120V	1Ø	3/4 hp
208V	3Ø	3 hp
240V	3Ø	5 hp
480V	3Ø	7 1/2 hp
600V	3Ø	10 hp
- Short Circuit Rating**
100kA Withstand
Tested with RK1 current limiting fuses sized at 400% of the highest full load motor ampacity.
- Environmental Ratings**
Type 4X
- Temperature Range**
Min -40°F/Max 104°F
See pg 271 for temps below -15°F.
- Wiring Capacity**
Min 14 AWG Max 8 AWG
Aux Contacts - Max 14 AWG
Based on THHN wire sizes
- Applicable Standards**
CSA C22.2 No. 182.1-07
C22.2 No. 213-M1987
- Hazardous Ratings**
Class I, Division 2, Groups ABCD, T6
Class I, Zone 2, IIC

Receptacle (female)



Inlet (male)



Hazardous Location DS20 lid is normally closed

! Don't forget to add installation accessories to your order

Voltage	Polarity	Part # Poly	Part # Poly
120V	1P+N+G	35-14165-xxx-HAZ	35-18165-xxx-HAZ
120 208V	3P+N+G	35-14167-xxx-HAZ	35-18167-xxx-HAZ
125V	1P+N+G	35-14075-xxx-HAZ	35-18075-xxx-HAZ
125 250V	2P+N+G	35-14076-xxx-HAZ	35-18076-xxx-HAZ
208V	2P+G	35-14162-xxx-HAZ	35-18162-xxx-HAZ
208V	3P+G	35-14163-xxx-HAZ	35-18163-xxx-HAZ
250V	2P+G	35-14072-xxx-HAZ	35-18072-xxx-HAZ
250V	3P+G	35-14073-xxx-HAZ	35-18073-xxx-HAZ
277V	1P+N+G	35-14045-xxx-HAZ	35-18045-xxx-HAZ
277 480V	3P+N+G	35-14047-xxx-HAZ	35-18047-xxx-HAZ
347 600V	3P+N+G	35-14147-xxx-HAZ	35-18147-xxx-HAZ
480V	2P+G	35-14042-xxx-HAZ	35-18042-xxx-HAZ
480V	3P+G	35-14043-xxx-HAZ	35-18043-xxx-HAZ
600V	2P+G	35-14142-xxx-HAZ	35-18142-xxx-HAZ
600V	3P+G	35-14143-xxx-HAZ	35-18143-xxx-HAZ

The xxx represents any and all device options; if no options are needed, the xxx suffix should be omitted.

Part Number Example

480V DS20 + 2 aux contacts
DS20 recept 3P+G = 35-14043-972-HAZ

480V DS20 with no options
DS20 recept 3P+G = 35-14043-HAZ

Receptacle Options	Suffix #	Inlet Options	Suffix #
With 2 Auxiliary/Pilot Contacts	Recept # - 972	With 2 Auxiliary/Pilot Contacts	Inlet # - 972
Normally Open Lid Configuration	Recept # - NO	With No Lockout Hole	Inlet # - A155

Feature Spotlight – Screw-Type Locking Pawl



! Listing Requirement
Users must tighten screw to lock the plug in the mated position

Zone 2/Division 2 DS20 receptacles feature a standard screw-type locking pawl. This required feature allows the user to lock the plug to the receptacle by tightening a screw on the pawl.

For added security, a lockout hole is included on the receptacle that enables the user to insert a 5/16" lock or locking pin to prevent the plug from being disconnected or to lock the receptacle lid closed.



5/16" hole for added security

! See pages 248-257 for detailed information on these options

INSTALLATION ACCESSORIES – SIZE 2

Accessories rated for hazardous locations are not returnable.

HANDLES

HANDLE w/NPT		Part # Poly	Part # Metal
	1/2"	552P0N05	5K2P0N05
	3/4"	552P0N07	5K2P0N07
	1"	552P0N10	5K2P0N10
	1 1/4"	552P0N12	-
	POLY HANDLE w/Cable Range		
	.20 - .82"	552P0D21	

For available cord grips, see pg 179.

i

Cable Range	NPT	Cable Range	NPT
.312 - .625	1/2"	.660 - 1.000	1"
.438 - .812	3/4"	.875 - 1.375"	1 1/4"

NPT sizes are determined by the cable diameter and third party cord grip.

BOXES



POLY ANGLE WITH METAL BOX w/NPT				
	30°	1/2"	752C3N05	
	30°	3/4"	752C3N07	
	30°	1"	752C3N10	
	* 28.7 in ³	30°	1 1/4"	752C3N12
	* Interior volume with receptacle installed.			

METAL ANGLE WITH METAL BOX w/NPT				
	30°	1/2"	7K2C3N05	
	30°	3/4"	7K2C3N07	
	30°	1"	7K2C3N10	
	* 28.7 in ³	30°	1 1/4"	7K2C3N12
	* Interior volume with receptacle installed.			



POLY ANGLE WITH LARGER METAL WALL BOX w/NPT				
	70°	1/2"	752C7N05	
	70°	3/4"	752C7N07	
	70°	1"	752C7N10	
	70°	1 1/4"	752C7N12	
	* 75.0 in ³	70°	1 1/2"	752C7N15
	* Interior volume with receptacle installed.			

NPT on top or bottom (if rotated). For other NPT configurations, contact customer service.

ANGLES

POLY ANGLE		
	30°	552M3
METAL ANGLE		
	0°	5K2M0
	30°	5K2M3

MISCELLANEOUS ACCESSORIES

FINGER DRAWPLATES		
	61-3A346	Set of Two (2) Recommended for easier connector closure.
PROTECTIVE CAP		
	31-1A426	For watertight seal, the male inlet must also be ordered with the "No Lockout Hole" option (-A155). For Male Devices Only.
RECEPTACLE LOCKING PIN		
	LP-843	

Notes: For Zone 2 DS dimensions refer to DS dimensions on pgs 54-55.

DS30 Hazardous Location Plugs & Receptacles – 30A

Devices rated for hazardous locations are not returnable.

SP US Ratings

- Voltage**
600 VAC
- Current Interruption Capability**
Not for current interrupting
- Horsepower Ratings**

120V	1Ø	1 1/2 hp
240V	1Ø	3 hp
208V	3Ø	5 hp
240V	3Ø	5 hp
480V	3Ø	15 hp
600V	3Ø	15 hp
- Short Circuit Rating**
100kA Withstand
Tested with RK1 current limiting fuses sized at 400% of the highest full load motor ampacity.
- Environmental Ratings**
Type 4X
- Temperature Range**
Min -40°F/Max 104°F
See pg 271 for temps below -15°F.
- Wiring Capacity**
Min 14 AWG Max 4 AWG
Aux Contacts - Max 14 AWG
Based on THHN wire sizes
- Applicable Standards**
CSA C22.2 No. 182.1-07
C22.2 No. 213-M1987
- Hazardous Ratings**
Class I, Division 2, Groups ABCD, T6
Class I, Zone 2, IIC

Receptacle (female)



Inlet (male)



Hazardous Location DS30 lid is normally closed

! Don't forget to add installation accessories to your order

Voltage	Polarity	Part # Poly	Part # Poly
120V	1P+N+G	35-34165-xxx-HAZ	35-38165-xxx-HAZ
120 208V	3P+N+G	35-34167-xxx-HAZ	35-38167-xxx-HAZ
125V	1P+N+G	35-34075-xxx-HAZ	35-38075-xxx-HAZ
125 250V	2P+N+G	35-34076-xxx-HAZ	35-38076-xxx-HAZ
208V	2P+G	35-34162-xxx-HAZ	35-38162-xxx-HAZ
208V	3P+G	35-34163-xxx-HAZ	35-38163-xxx-HAZ
250V	2P+G	35-34072-xxx-HAZ	35-38072-xxx-HAZ
250V	3P+G	35-34073-xxx-HAZ	35-38073-xxx-HAZ
277V	1P+N+G	35-34045-xxx-HAZ	35-38045-xxx-HAZ
277 480V	3P+N+G	35-34047-xxx-HAZ	35-38047-xxx-HAZ
347 600V	3P+N+G	35-34147-xxx-HAZ	35-38147-xxx-HAZ
480V	2P+G	35-34042-xxx-HAZ	35-38042-xxx-HAZ
480V	3P+G	35-34043-xxx-HAZ	35-38043-xxx-HAZ
600V	2P+G	35-34142-xxx-HAZ	35-38142-xxx-HAZ
600V	3P+G	35-34143-xxx-HAZ	35-38143-xxx-HAZ

The xxx represents any and all device options; if no options are needed, the xxx suffix should be omitted.

Part Number Example

480V DS30 + 2 aux contacts

DS30 recept 3P+G = 35-34043-972-HAZ

480V DS30 with no options

DS30 recept 3P+G = 35-34043-HAZ

Receptacle Options	Suffix #	Inlet Options	Suffix #
With 2 Auxiliary/Pilot Contacts	Recept # - 972	With 2 Auxiliary/Pilot Contacts	Inlet # - 972
With 3 Auxiliary/Pilot Contacts	Recept # - 973	With 3 Auxiliary/Pilot Contacts	Inlet # - 973
With 4 Auxiliary/Pilot Contacts	Recept # - 974	With 4 Auxiliary/Pilot Contacts	Inlet # - 974
Open Lid Configuration	Recept # - NO	With No Lockout Hole	Inlet # - A155

Feature Spotlight – Screw-Type Locking Pawl



! Listing Requirement
Users must tighten screw to lock the plug in the mated position

Zone 2/Division 2 DS30 receptacles feature a standard screw-type locking pawl. This required feature allows the user to lock the plug to the receptacle by tightening a screw on the pawl.

For added security, a lockout hole is included on the receptacle that enables the user to insert a 5/16" lock or locking pin to prevent the plug from being disconnected or to lock the receptacle lid closed.





5/16" hole for added security

! See pages 248-257 for detailed information on these options

INSTALLATION ACCESSORIES – SIZE 3

Accessories rated for hazardous locations are not returnable.

HANDLES

HANDLE w/NPT		Part # Poly	Part # Metal
	1/2"	553P0N05	5K3P0N05
	3/4"	553P0N07	5K3P0N07
	1"	553P0N10	5K3P0N10
	1 1/4"	553P0N12	5K3P0N12

POLY HANDLE w/Cable Range

	.39 - 1.18"	553P0D30
---	-------------	----------

For available cord grips, see pg 179.



Cable Range	NPT	Cable Range	NPT
.312 - .625	1/2"	.660 - 1.000	1"
.438 - .812	3/4"	.875 - 1.375"	1 1/4"

NPT sizes are determined by the cable diameter and third party cord grip.

BOXES

POLY ANGLE WITH METAL BOX w/NPT

	30°	1/2"	753C3N05	* Interior volume with receptacle installed.
	30°	3/4"	753C3N07	
	30°	1"	753C3N10	
* 29.6 in ³	30°	1 1/4"	753C3N12	

METAL ANGLE WITH METAL BOX w/NPT

	30°	1/2"	7K3C3N05	* Interior volume with receptacle installed.
	30°	3/4"	7K3C3N07	
	30°	1"	7K3C3N10	
* 29.6 in ³	30°	1 1/4"	7K2C3N12	

POLY ANGLE WITH LARGER METAL WALL BOX w/NPT

	70°	1/2"	753C7N05	* Interior volume with receptacle installed.
	70°	3/4"	753C7N07	
	70°	1"	753C7N10	
* 170.0 in ³	70°	1 1/4"	753C7N12	
	70°	1 1/2"	753C7N15	

METAL ANGLE WITH METAL BOX w/NPT

	70°	1/2"	7K3C7N05	* Interior volume with receptacle installed.
	70°	3/4"	7K3C7N07	
	70°	1"	7K3C7N10	
* 27.7 in ³	70°	1 1/4"	7K2C7N12	
	70°	1 1/2"	7K2C7N15	



NPT on top or bottom (if rotated). For other NPT configurations, contact customer service.

ANGLES

POLY ANGLE

	30°	553M3
---	-----	-------

METAL ANGLE

	0°	5K3M0
	30°	5K3M3
	70°	5K3M7

MISCELLANEOUS ACCESSORIES

FINGER DRAWPLATES

	61-6A346	Set of Two (2) Recommended for easier connector closure.
---	----------	---

PROTECTIVE CAP

	31-3A426	For watertight seal, the male inlet must also be ordered with the "No Lockout Hole" option (-A155). For Male Devices Only.
---	----------	---

RECEPTACLE LOCKING PIN

	LP-843
---	--------

Notes: For Zone 2 DS dimensions refer to DS dimensions on pgs 54-55.

DS60 Hazardous Location Plugs & Receptacles – 60A

Devices rated for hazardous locations are not returnable.

SP US Ratings

- Voltage**
600 VAC
- Current Interruption Capability**
Not for current interrupting
- Horsepower Ratings**

120V	1Ø	3 hp
240V	1Ø	5 hp
208V	3Ø	10 hp
240V	3Ø	10 hp
480V	3Ø	25 hp
600V	3Ø	25 hp
- Short Circuit Rating**
100kA Withstand
Testing was performed with RK1 current limiting fuses sized at 400% of the highest full load motor ampacity associated with the devices hp rating.
- Environmental Ratings**
Type 4X
- Temperature Range**
Min -40°F/Max 104°F
See pg 271 for temps below -15°F.
- Wiring Capacity**
Min 10 AWG Max 2 AWG
Aux Contacts - Max 14 AWG
Based on THHN wire sizes
- Applicable Standards**
CSA C22.2 No. 182.1-07
C22.2 No. 213-M1987
- Hazardous Ratings**
Class I, Division 2, Groups ABCD, T6
Class I, Zone 2, IIC

Receptacle (female)



Inlet (male)



Hazardous Location DS60 lid is normally closed and opens to 120°

! Don't forget to add installation accessories to your order

Voltage	Polarity	Part # Metal	Part # Metal
120V	1P+N+G	36-64165-xxx-HAZ	36-68165-xxx-HAZ
120 208V	3P+N+G	36-64167-xxx-HAZ	36-68167-xxx-HAZ
125V	1P+N+G	36-64075-xxx-HAZ	36-68075-xxx-HAZ
125 250V	2P+N+G	36-64076-xxx-HAZ	36-68076-xxx-HAZ
208V	2P+G	36-64162-xxx-HAZ	36-68162-xxx-HAZ
208V	3P+G	36-64163-xxx-HAZ	36-68163-xxx-HAZ
250V	2P+G	36-64072-xxx-HAZ	36-68072-xxx-HAZ
250V	3P+G	36-64073-xxx-HAZ	36-68073-xxx-HAZ
277V	1P+N+G	36-64045-xxx-HAZ	36-68045-xxx-HAZ
277 480V	3P+N+G	36-64047-xxx-HAZ	36-68047-xxx-HAZ
347 600V	3P+N+G	36-64147-xxx-HAZ	36-68147-xxx-HAZ
480V	2P+G	36-64042-xxx-HAZ	36-68042-xxx-HAZ
480V	3P+G	36-64043-xxx-HAZ	36-68043-xxx-HAZ
600V	2P+G	36-64142-xxx-HAZ	36-68142-xxx-HAZ
600V	3P+G	36-64143-xxx-HAZ	36-68143-xxx-HAZ

The xxx represents any and all device options; if no options are needed, the xxx suffix should be omitted.

Part Number Example

480V DS60 + 2 aux contacts

DS60 recept 3P+G = 36-64043-972-HAZ

480V DS60 with no options

DS60 recept 3P+G = 36-64043-HAZ

Receptacle Options	Suffix #	Inlet Options	Suffix #
With 2 Auxiliary/Pilot Contacts	Recept # - 972	With 2 Auxiliary/Pilot Contacts	Inlet # - 972
With 3 Auxiliary/Pilot Contacts	Recept # - 263	With 3 Auxiliary/Pilot Contacts	Inlet # - 263
With 4 Auxiliary/Pilot Contacts	Recept # - 264	With 4 Auxiliary/Pilot Contacts	Inlet # - 264
Normally Open Lid Configuration	Recept # - NO	With No Lockout Hole	Inlet # - A155
180° Opening Lid	Recept # - 180		

Feature Spotlight – Screw-Type Locking Pawl

! Listing Requirement
Users must tighten screw to lock the plug in the mated position



Zone 2/Division 2 DS60 receptacles feature a standard screw-type locking pawl. This required feature allows the user to lock the plug in the receptacle by tightening a screw on the pawl.

For added security, a lockout hole is included on the receptacle that enables the user to insert a 5/16" lock or locking pin to prevent the plug from being disconnected or to lock the receptacle lid closed.





5/16" hole for added security

! See pages 248-257 for detailed information on these options

INSTALLATION ACCESSORIES – SIZE 4

Accessories rated for hazardous locations are not returnable.

HANDLES

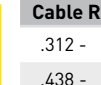
HANDLE w/NPT	Part # Poly	Part # Metal
 1/2"	554P0N05	5K4P0N05
 3/4"	554P0N07	5K4P0N07
poly  1"	554P0N10	5K4P0N10
 1 1/4"	554P0N12	5K4P0N12
metal  1 1/2"	554P0N15	5K4P0N15
POLY HANDLE w/Cable Range		
 .51 - 1.38"	554P0D35	



For available cord grips, see pg 179.

i



Cable Range	NPT	Cable Range	NPT
.312 - .625	1/2"	.875 - 1.375"	1 1/4"
.438 - .812	3/4"	.890 - 1.812"	1 1/2"
.660 - 1.000	1"		

NPT sizes are determined by the cable diameter and third party cord grip.



BOXES

POLY ANGLE WITH METAL BOX w/NPT			
 30° 1"			754C3N10
 30° 1 1/4"			754C3N12
 30° 1 1/2"			754C3N15
* 61.0 in ³	30° 2"	754C3N20	

* Interior volume with receptacle installed.

METAL ANGLE WITH METAL BOX w/NPT			
 30° 1"			7K4C3N10
 30° 1 1/4"			7K4C3N12
 30° 1 1/2"			7K4C3N15
* 59.4 in ³	30° 2"	7K4C3N20	





* Interior volume with receptacle installed.

METAL ANGLE WITH METAL BOX w/NPT			
 70° 1"			7K4C7N10
 70° 1 1/4"			7K4C7N12
 70° 1 1/2"			7K4C7N15
* 91.0 in ³	70° 2"	7K4C7N20	





* Interior volume with receptacle installed.

NPT on top or bottom (if rotated). For other NPT configurations, contact customer service.

ANGLES

POLY ANGLE		
 30°	554M3	
METAL ANGLE		
 0°	5K4M0	
 30°	5K4M3	
 70°	5K4M7	

MISCELLANEOUS ACCESSORIES

FINGER DRAWPLATES		
 31-6A346	Set of Two (2) Recommended for easier connector closure.	
PROTECTIVE CAP		
 31-6A426	For watertight seal, the male inlet must also be ordered with the "No Lockout Hole" option (-A155). For Male Devices Only.	
PADLOCKABLE PLUG CAP		
 DS6MC	Aluminum – For Male Devices Only.	
RECEPTACLE LOCKING PIN		
 LP-843		

Notes: For Zone 2 DS dimensions refer to DS dimensions on pgs 54-55.

DS100C Hazardous Location Plugs & Receptacles – 100A

Devices rated for hazardous locations are not returnable.

SP US Ratings

- Voltage**
600 VAC
- Current Interruption Capability**
Not for current interrupting
- Horsepower Ratings**

120V	1Ø	5 hp
240V	1Ø	10 hp
208V	3Ø	20 hp
240V	3Ø	20 hp
480V	3Ø	50 hp
600V	3Ø	50 hp
- Short Circuit Rating**
100kA Withstand
Testing was performed with RK1 current limiting fuses sized at 400% of the highest full load motor ampacity associated with the devices hp rating.
- Environmental Ratings**
Type 4X
- Temperature Range**
Min -40°F/Max 104°F
See pg 271 for temps below -15°F.
- Wiring Capacity**
Min 10 AWG Max 2 AWG
Aux Contacts - Max 14 AWG
Based on THHN wire sizes
- Applicable Standards**
CSA C22.2 No. 182.1-07
C22.2 No. 213-M1987
- Hazardous Ratings**
Class I, Division 2, Groups ABCD, T6
Class I, Zone 2, IIC

Receptacle (female)



Inlet (male)



! Don't forget to add installation accessories to your order

Hazardous Location DS100C lid is normally closed and opens to 120°

Voltage	Polarity	Part #		Part #	
		Poly	Metal	Poly	Metal
120V	1P+N+G	35-64235-C-K16-xxx-HAZ	36-64235-C-K16-xxx-HAZ	35-68235-C-K16-xxx-HAZ	36-68235-C-K16-xxx-HAZ
120 208V	3P+N+G	35-64237-C-K16-xxx-HAZ	36-64236-C-K16-xxx-HAZ	35-68237-C-K16-xxx-HAZ	36-68236-C-K16-xxx-HAZ
125V	1P+N+G	35-64175-C-K07-xxx-HAZ	36-64175-C-K07-xxx-HAZ	35-68175-C-K07-xxx-HAZ	36-68175-C-K07-xxx-HAZ
125 250V	2P+N+G	35-64176-C-K07-xxx-HAZ	36-64176-C-K07-xxx-HAZ	35-68176-C-K07-xxx-HAZ	36-68176-C-K07-xxx-HAZ
208V	2P+G	35-64232-C-K16-xxx-HAZ	36-64232-C-K16-xxx-HAZ	35-68232-C-K16-xxx-HAZ	36-68232-C-K16-xxx-HAZ
208V	3P+G	35-64235-C-K16-xxx-HAZ	36-64233-C-K16-xxx-HAZ	35-68235-C-K16-xxx-HAZ	36-68233-C-K16-xxx-HAZ
250V	2P+G	35-64172-C-K07-xxx-HAZ	36-64172-C-K07-xxx-HAZ	35-68172-C-K07-xxx-HAZ	36-68172-C-K07-xxx-HAZ
250V	3P+G	35-64173-C-K07-xxx-HAZ	36-64173-C-K07-xxx-HAZ	35-68173-C-K07-xxx-HAZ	36-68173-C-K07-xxx-HAZ
277V	1P+N+G	35-64245-C-K04-xxx-HAZ	36-64245-C-K04-xxx-HAZ	35-68245-C-K04-xxx-HAZ	36-68245-C-K04-xxx-HAZ
277 480V	3P+N+G	35-64247-C-K04-xxx-HAZ	36-64247-C-K04-xxx-HAZ	35-68247-C-K04-xxx-HAZ	36-68247-C-K04-xxx-HAZ
347 600V	3P+N+G	35-64187-C-K14-xxx-HAZ	36-64187-C-K14-xxx-HAZ	35-68187-C-K14-xxx-HAZ	36-68187-C-K14-xxx-HAZ
480V	2P+G	35-64242-C-K04-xxx-HAZ	36-64242-C-K04-xxx-HAZ	35-68242-C-K04-xxx-HAZ	36-68242-C-K04-xxx-HAZ
480V	3P+G	35-64243-C-K04-xxx-HAZ	36-64243-C-K04-xxx-HAZ	35-68243-C-K04-xxx-HAZ	36-68243-C-K04-xxx-HAZ
600V	2P+G	35-64182-C-K14-xxx-HAZ	36-64182-C-K14-xxx-HAZ	35-68182-C-K14-xxx-HAZ	36-68182-C-K14-xxx-HAZ
600V	3P+G	35-64183-C-K14-xxx-HAZ	36-64183-C-K14-xxx-HAZ	35-68183-C-K14-xxx-HAZ	36-68183-C-K14-xxx-HAZ

The xxx represents any and all device options; if no options are needed, the xxx suffix should be omitted.

Part Number Example

480V DS100C + 2 aux contacts

DS100C Poly recept 3P+G = 35-64243-C-K04-972-HAZ

480V DS100C with no options

DS100C Poly recept 3P+G = 35-64243-C-K04-HAZ

Receptacle Options	Suffix #	Inlet Options	Suffix #
With 2 Auxiliary/Pilot Contacts	Recept # - 972	With 2 Auxiliary/Pilot Contacts	Inlet # - 972
With 3 Auxiliary/Pilot Contacts	Recept # - 263	With 3 Auxiliary/Pilot Contacts	Inlet # - 263
With 4 Auxiliary/Pilot Contacts	Recept # - 264	With 4 Auxiliary/Pilot Contacts	Inlet # - 264
Normally Open Lid Configuration	Recept # - NO	With No Lockout Hole	Inlet # - A155
180° Opening Lid (metal only)	Recept # - 180		

Feature Spotlight – Screw-Type Locking Pawl



! Listing Requirement
Users must tighten screw to lock the plug in the mated position

Zone 2/Division 2 DS100C receptacles feature a standard screw-type locking pawl. This required feature allows the user to lock the plug to the receptacle by tightening a screw on the pawl.



For added security, a lockout hole is included on the receptacle that enables the user to insert a 5/16" lock or locking pin to prevent the plug from being disconnected or to lock the receptacle lid closed.

5/16" hole for added security

! See pages 248-257 for detailed information on these options

INSTALLATION ACCESSORIES – SIZE 4

Accessories rated for hazardous locations are not returnable.

HANDLES	HANDLE w/NPT		Part # Poly	Part # Metal
		1/2"		554P0N05
3/4"			554P0N07	5K4P0N07
poly	1"		554P0N10	5K4P0N10
	1 1/4"		554P0N12	5K4P0N12
	1 1/2"		554P0N15	5K4P0N15
	POLY HANDLE w/Cable Range			
	.51 - 1.38"		554P0D35	

For available cord grips, see pg 179.

i

Cable Range	NPT	Cable Range	NPT
.312 - .625	1/2"	.875 - 1.375"	1 1/4"
.438 - .812	3/4"	.890 - 1.812"	1 1/2"
.660 - 1.000	1"		

NPT sizes are determined by the cable diameter and third party cord grip.

BOXES	POLY ANGLE WITH METAL BOX w/NPT			* Interior volume with receptacle installed.
		30°	1"	
30°		1 1/4"	754C3N12	
30°		1 1/2"	754C3N15	
30°		2"	754C3N20	

* 61.0 in³





METAL ANGLE WITH METAL BOX w/NPT			
	30°	1"	7K4C3N10
	30°	1 1/4"	7K4C3N12
	30°	1 1/2"	7K4C3N15
	30°	2"	7K4C3N20





* 59.4 in³

METAL ANGLE WITH METAL BOX w/NPT			
	70°	1"	7K4C7N10
	70°	1 1/4"	7K4C7N12
	70°	1 1/2"	7K4C7N15
	70°	2"	7K4C7N20

* 170.0 in³

NPT on top or bottom (if rotated). For other NPT configurations, contact customer service.

ANGLES	POLY ANGLE	
		30°
METAL ANGLE		
	0°	5K4M0
	30°	5K4M3
	70°	5K4M7

MISCELLANEOUS ACCESSORIES	FINGER DRAWPLATES		
		31-6A346	Set of Two (2) Recommended for cord to cord assembly applications, for easier connector closure.
	PROTECTIVE CAP		
		31-6A426	For watertight seal, the male inlet must also be ordered with the "No Lockout Hole" option (-A155). For Male Devices Only.
	PADLOCKABLE PLUG CAP		
		DS6MC	Aluminum – For Male Devices Only.
RECEPTACLE LOCKING PIN			
	LP-843		

Notes: For Zone 2 DS dimensions refer to DS dimensions on pgs 54-55.

DSN150 Hazardous Location Plugs & Receptacles – 150A

Devices rated for hazardous locations are not returnable.

SP US Ratings

- Voltage**
600 VAC
- Current Interruption Capability**
Not for current interrupting
- Horsepower Ratings**

120V	1Ø	7 1/2 hp
240V	1Ø	20 hp
208V	3Ø	30 hp
240V	3Ø	30 hp
480V	3Ø	75 hp
600V	3Ø	75 hp
- Short Circuit Rating**
100kA Withstand
Testing was performed with 225A RK1 non-time delay Mersen fuses.
10kA Withstand
Testing was performed with 400A RK1 non-time delay Mersen fuses.
- Environmental Ratings**
Type 4X
- Temperature Range**
Min -40°F/Max 104°F
See pg 271 for temps below -15°F.
- Wiring Capacity**
Min 4 AWG Max 2/0 AWG
Aux Contacts - Max 14 AWG
- Applicable Standards**
CSA C22.2 No. 182.1-07
C22.2 No. 213-M1987
- Hazardous Ratings**
Class I, Division 2, Groups ABCD, T6
Class I, Zone 2, IIC

Receptacle (female)



Inlet (male)



Hazardous Location DSN150 lid is normally closed and opens to 90°

! Don't forget to add installation accessories to your order

Voltage	Polarity	Part # Metal	Part # Metal
120V	1P+N+G	66-94165-xxx-HAZ	66-98165-xxx-HAZ
120 208V	3P+N+G	66-94167-xxx-HAZ	66-98167-xxx-HAZ
125V	1P+N+G	66-94075-xxx-HAZ	66-98075-xxx-HAZ
125 250V	2P+N+G	66-94076-xxx-HAZ	66-98076-xxx-HAZ
208V	2P+G	66-94162-xxx-HAZ	66-98162-xxx-HAZ
208V	3P+G	66-94163-xxx-HAZ	66-98163-xxx-HAZ
250V	2P+G	66-94072-xxx-HAZ	66-98072-xxx-HAZ
250V	3P+G	66-94073-xxx-HAZ	66-98073-xxx-HAZ
277V	1P+N+G	66-94045-xxx-HAZ	66-98045-xxx-HAZ
277 480V	3P+N+G	66-94047-xxx-HAZ	66-98047-xxx-HAZ
347 600V	3P+N+G	66-94147-xxx-HAZ	66-98147-xxx-HAZ
480V	2P+G	66-94042-xxx-HAZ	66-98042-xxx-HAZ
480V	3P+G	66-94043-xxx-HAZ	66-98043-xxx-HAZ
600V	2P+G	66-94142-xxx-HAZ	66-98142-xxx-HAZ
600V	3P+G	66-94143-xxx-HAZ	66-98143-xxx-HAZ

The xxx represents any and all device options; if no options are needed, the xxx suffix should be omitted.

Part Number Example

480V DSN150 + 2 aux contacts

DSN150 recept 3P+G = 66-94043-262-HAZ

480V DSN150 with no options

DSN150 recept 3P+G = 66-94043-HAZ

Receptacle Options	Suffix #	Inlet Options	Suffix #
With 2 Auxiliary/Pilot Contacts	Recept # - 262	With 2 Auxiliary/Pilot Contacts	Inlet # - 262
With 3 Auxiliary/Pilot Contacts	Recept # - 263	With 3 Auxiliary/Pilot Contacts	Inlet # - 263
With 4 Auxiliary/Pilot Contacts	Recept # - 264	With 4 Auxiliary/Pilot Contacts	Inlet # - 264
With 5 Auxiliary/Pilot Contacts	Recept # - 975	With 5 Auxiliary/Pilot Contacts	Inlet # - 975
With 6 Auxiliary/Pilot Contacts	Recept # - 976	With 6 Auxiliary/Pilot Contacts	Inlet # - 976
180° Opening Lid	Recept # - 180**	With No Lockout Hole	Inlet # - A155
Normally Open Lid Configuration	Recept # - NO		

Notes: ** Required when mating to panel mounted male inlet.

Feature Spotlight – Screw-Type Locking Pawl



! Listing Requirement
Users must tighten screw to lock the plug in the mated position

5/16" hole for added security

Zone 2/Division 2 DSN150 receptacles feature a standard screw-type locking pawl. This required feature allows the user to lock the plug to the receptacle by tightening a screw on the pawl. For added security, a lockout hole is included on the receptacle that enables the user to insert a 5/16" lock or locking pin to prevent the plug from being disconnected or to lock the receptacle lid closed.

! See pages 248-257 for detailed information on these options

INSTALLATION ACCESSORIES – SIZE 5

Accessories rated for hazardous locations are not returnable.

HANDLES

METAL HANDLE w/NPT Part #

	3/4"	5K5P0N07	For available third party cord grips, consult factory.
	1"	5K5P0N10	
	1 1/4"	5K5P0N12	
	1 1/2"	5K5P0N15	
	2"	5K5P0N20	

OVERSIZED METAL HANDLE w/NPT

	3/4"	7K5P0N07
	1"	7K5P0N10
	1 1/4"	7K5P0N12
	1 1/2"	7K5P0N15
	2"	7K5P0N20
	2 1/2"	7K5P0N25

SANTOPRENE HANDLE w/Cable Range

	.70 - 1.00"	555P0D25
IP 66/67	.984 - 1.377"	555P0D35
	1.377 - 1.771"	555P0D45

BOXES

METAL ANGLE WITH METAL BOX w/NPT

	30°	1 1/4"	7K5C3N12	* Interior volume with receptacle installed.
	30°	1 1/2"	7K5C3N15	
	30°	2"	7K5C3N20	
111.8 in ³	30°	2 1/2"	7K5C3N25	

METAL ANGLE WITH METAL BOX w/NPT

	70°	1 1/4"	7K5C7N12	* Interior volume with receptacle installed.
	70°	1 1/2"	7K5C7N15	
	70°	2"	7K5C7N20	
175.0 in ³	70°	2 1/2"	7K5C7N25	

NPT on top or bottom (if rotated). For other NPT configurations, contact customer service.

i

Cable Range	NPT	Cable Range	NPT
.438 - .812"	3/4"	.890" - 1.812"	1 1/2"
.660 - 1.000"	1"	1.190" - 2.438"	2"
.875 - 1.375"	1 1/4"	2.062" - 2.438"	2 1/2"

NPT sizes are determined by the cable diameter and third party cord grip.

ANGLES

METAL ANGLE

	0°	5K5M0
	30°	5K5M3
	70°	5K5M7

MISCELLANEOUS ACCESSORIES

PROTECTIVE CAP

	35-9A126	For watertight seal, the male inlet must also be ordered with the 'No Lockout Hole' option (-A155). For Male Devices Only.
---	-----------------	---

PADLOCKABLE PLUG CAP

	DS9MC	Aluminum – For Male Devices Only.
---	--------------	-----------------------------------

CORD GRIP

	see pg 179
---	------------

RECEPTACLE LOCKING PIN

	LP-843
---	---------------

Notes: For Zone 2 DSN dimensions refer to DSN dimensions on pgs 36-37.

DS200 Hazardous Location Plugs & Receptacles – 200A

Devices rated for hazardous locations are not returnable.

SP US Ratings

- Voltage**
600 VAC
- Current Interruption Capability**
Not for current interrupting
- Horsepower Ratings**

208V	3Ø	40 hp
240V	3Ø	40 hp
480V	3Ø	100 hp
600V	3Ø	100 hp
- Short Circuit Rating**
10kA Withstand
Tested with RK1 current limiting fuses sized at 400% of the highest full load-motor ampacity..
- Environmental Ratings**
Type 4X
- Temperature Range**
Min -40°F/Max 104°F
See pg 271 for temps below -15°F.
- Wiring Capacity**
Min 4 AWG Max 4/0 AWG
Aux Contacts - Max 14 AWG
Based on THHN wire sizes
- Applicable Standards**
CSA C22.2 No. 182.1-07
C22.2 No. 213-M1987
- Hazardous Ratings**
Class I, Division 2, Groups ABCD, T6
Class I, Zone 2, IIC



! Don't forget to add installation accessories to your order

Voltage	Polarity	Part # Metal	Part # Metal
120V	1P+N+G	36-24165-xxx-HAZ	36-28165-xxx-HAZ
120 208V	3P+N+G	36-24167-xxx-HAZ	36-28167-xxx-HAZ
125V	1P+N+G	36-24075-xxx-HAZ	36-28075-xxx-HAZ
125 250V	2P+N+G	36-24076-xxx-HAZ	36-28076-xxx-HAZ
208V	2P+G	36-24162-xxx-HAZ	36-28162-xxx-HAZ
208V	3P+G	36-24163-xxx-HAZ	36-28163-xxx-HAZ
250V	2P+G	36-24072-xxx-HAZ	36-28072-xxx-HAZ
250V	3P+G	36-24073-xxx-HAZ	36-28073-xxx-HAZ
277V	1P+N+G	36-24045-xxx-HAZ	36-28045-xxx-HAZ
277 480V	3P+N+G	36-24047-xxx-HAZ	36-28047-xxx-HAZ
347 600V	3P+N+G	36-24147-xxx-HAZ	36-28147-xxx-HAZ
480V	2P+G	36-24042-xxx-HAZ	36-28042-xxx-HAZ
480V	3P+G	36-24043-xxx-HAZ	36-28043-xxx-HAZ
600V	2P+G	36-24142-xxx-HAZ	36-28142-xxx-HAZ
600V	3P+G	36-24143-xxx-HAZ	36-28143-xxx-HAZ

The xxx represents any and all device options; if no options are needed, the xxx suffix should be omitted.

Part Number Example

480V DS200 + 2 aux contacts
DS200 recept 3P+G = 36-24043-972-HAZ

480V DS200 with no options
DS200 recept 3P+G = 36-24043-HAZ

Receptacle Options	Suffix #	Inlet Options	Suffix #
With 2 Auxiliary/Pilot Contacts	Recept # - 972	With 2 Auxiliary/Pilot Contacts	Inlet # - 972
With 4 Auxiliary/Pilot Contacts	Recept # - 174	With 4 Auxiliary/Pilot Contacts	Inlet # - 174
With 6 Auxiliary/Pilot Contacts	Recept # - 976	With 6 Auxiliary/Pilot Contacts	Inlet # - 976
180° Opening Lid	Recept # - 180**	With No Lockout Hole	Inlet # - A155
Normally Open Lid Configuration	Recept # - NO		

Notes: ** Required when mating to panel mounted male inlet.

Feature Spotlight – Screw-Type Locking Pawl



! Listing Requirement
Users must tighten screw to lock the plug in the mated position

5/16" hole for added security

Zone 2/Division 2 DS200 receptacles feature a standard screw-type locking pawl. This required feature allows the user to lock the plug to the receptacle by tightening a screw on the pawl. For added security, a lockout hole is included on the receptacle that enables the user to insert a 5/16" lock or locking pin to prevent the plug from being disconnected or to lock the receptacle lid closed.

! See pages 248-257 for detailed information on these options

INSTALLATION ACCESSORIES – SIZE 6

Accessories rated for hazardous locations are not returnable.

HANDLES

HANDLE w/NPT	Part # Metal
1"	5K6P0N10
1 1/4"	5K6P0N12
1 1/2"	5K6P0N15
2"	5K6P0N20
2 1/2"	5K6P0N25
3"	5K6P0N30



SANTOPRENE HANDLE w/Cable Range

.984 - 1.377"	556P0D35
1.377 - 1.771"	556P0D45
1.771 - 1.929"	556P0D49



IP 66/67

For available cord grips, see pg 179.

BOXES

METAL ANGLE WITH METAL BOX w/NPT	Part #
60° 1 1/2"	7K6C6N15
60° 2"	7K6C6N20
60° 2 1/2"	7K6C6N25



* 248.4 in³

* Interior volume with receptacle installed.

NPT on top or bottom (if rotated). For other NPT configurations, contact customer service.



Cable Range	NPT	Cable Range	NPT
.660 - 1.000	1"	1.190 - 2.438"	2"
.875 - 1.375"	1 1/4"	2.062 - 2.438"	2 1/2"
.890 - 1.812"	1 1/2"	2.438 - 2.812"	3"

NPT sizes are determined by the cable diameter and third party cord grip.

ANGLES

METAL ANGLE	Part # Metal
0°	5K6M0



60°

5K6M6

MISCELLANEOUS ACCESSORIES

PROTECTIVE CAP



35-2A126

For watertight seal, the male inlet must also be ordered with the 'No Lockout Hole' option (-A155).
For Male Devices Only.

PADLOCKABLE PLUG CAP



DS2MC

For watertight seal, the male inlet must also be ordered with the 'No Lockout Hole' option (-A155).
Aluminum – For Male Devices Only.

CORD GRIP with MESH



see pg 178

RECEPTACLE LOCKING PIN



LP-843

HAZARDOUS LOCATION

Notes: For Zone 2 DS dimensions refer to DS dimensions on pgs 54-55.

DR30 Hazardous Location Plugs & Receptacles – 30A

Devices rated for hazardous locations are not returnable.

SP US Ratings

- Voltage**
600 VAC
- Current Interruption Capability**
Not for current interrupting
- Short Circuit Rating**
100kA Withstand
Testing was performed with RK1 current limiting fuses sized at 100% of the devices ampacity rating.
- Environmental Ratings**
Type 4X
- Temperature Range**
Min -40°F/Max 104°F
See pg 271 for temps below -15°F.
- Wiring Capacity**
Min 14 AWG Max 8 AWG
Aux Contacts - Max 14 AWG
Based on THHN wire sizes
- Applicable Standards**
CSA C22.2 No. 182.1-07
C22.2 No. 213-M1987
- Hazardous Ratings**
Class I, Division 2, Groups ABCD, T6
Class I, Zone 2, IIC

Receptacle (female)



Inlet (male)



Hazardous Location DR30 lid is normally closed

! Don't forget to add installation accessories to your order

Voltage	Polarity	Part # Poly	Part # Poly
120V	1P+N+G	35-14235-K16-xxx-HAZ	35-18235-K16-xxx-HAZ
120 208V	3P+N+G	35-14237-K16-xxx-HAZ	35-18237-K16-xxx-HAZ
125V	1P+N+G	35-14175-K07-xxx-HAZ	35-18175-K07-xxx-HAZ
125 250V	2P+N+G	35-14176-K07-xxx-HAZ	35-18176-K07-xxx-HAZ
208V	2P+G	35-14232-K16-xxx-HAZ	35-18232-K16-xxx-HAZ
208V	3P+G	35-14233-K16-xxx-HAZ	35-18233-K16-xxx-HAZ
250V	2P+G	35-14172-K07-xxx-HAZ	35-18172-K07-xxx-HAZ
250V	3P+G	35-14173-K07-xxx-HAZ	35-18173-K07-xxx-HAZ
277V	1P+N+G	35-14245-K04-xxx-HAZ	35-18245-K04-xxx-HAZ
277 480V	3P+N+G	35-14247-K04-xxx-HAZ	35-18247-K04-xxx-HAZ
347 600V	3P+N+G	35-14187-K14-xxx-HAZ	35-18187-K14-xxx-HAZ
480V	2P+G	35-14242-K04-xxx-HAZ	35-18242-K04-xxx-HAZ
480V	3P+G	35-14243-K04-xxx-HAZ	35-18243-K04-xxx-HAZ
600V	2P+G	35-14182-K14-xxx-HAZ	35-18182-K14-xxx-HAZ
600V	3P+G	35-14183-K14-xxx-HAZ	35-18183-K14-xxx-HAZ

The xxx represents any and all device options; if no options are needed, the xxx suffix should be omitted.

Part Number Example

480V DR30 + 2 aux contacts
DR30 recept 3P+G = 35-14243-K04-972-HAZ

480V DR30 with no options
DR30 recept 3P+G = 35-14243-K04-HAZ

Receptacle Options	Suffix #	Inlet Options	Suffix #
With 2 Auxiliary/Pilot Contacts	Recept # - 972	With 2 Auxiliary/Pilot Contacts	Inlet # - 972
Normally Open Lid Configuration	Recept # - NO	With No Lockout Hole	Inlet # - A155

Feature Spotlight – Screw-Type Locking Pawl



! Listing Requirement
Users must tighten screw to lock the plug in the mated position

Zone 2/Division 2 DR30 receptacles feature a standard screw-type locking pawl. This required feature allows the user to lock the plug to the receptacle by tightening a screw on the pawl.

For added security, a lockout hole is included on the receptacle that enables the user to insert a 5/16" lock or locking pin to prevent the plug from being disconnected or to lock the receptacle lid closed.





5/16" hole for added security

! See pages 248-257 for detailed information on these options

INSTALLATION ACCESSORIES – SIZE 2

Accessories rated for hazardous locations are not returnable.

HANDLES

HANDLE w/NPT	Part # Poly	Part # Metal
 1/2"	552P0N05	5K2P0N05
 3/4"	552P0N07	5K2P0N07
 1"	552P0N10	5K2P0N10
 1 1/4"	552P0N12	-

POLY HANDLE w/Cable Range	
 .20 - .82"	552P0D21

For available cord grips, see pg 179.

i

Cable Range	NPT	Cable Range	NPT
.312 - .625"	1/2"	.660 - 1.000	1"
.438 - .812"	3/4"	.875 - 1.375"	1 1/4"

NPT sizes are determined by the cable diameter and third party cord grip.

BOXES

POLY ANGLE WITH METAL BOX w/NPT			
	30°	1/2"	752C3N05
	30°	3/4"	752C3N07
	30°	1"	752C3N10
* 28.7 in ³	30°	1 1/4"	752C3N12

* Interior volume with receptacle installed.

METAL ANGLE WITH METAL BOX w/NPT			
	30°	1/2"	7K2C3N05
	30°	3/4"	7K2C3N07
	30°	1"	7K2C3N10
* 28.7 in ³	30°	1 1/4"	7K2C3N12

* Interior volume with receptacle installed.



POLY ANGLE WITH LARGER METAL WALL BOX w/NPT			
	70°	1/2"	752C7N05
	70°	3/4"	752C7N07
	70°	1"	752C7N10
* 75.0 in ³	70°	1 1/4"	752C7N12
	70°	1 1/2"	752C7N15

* Interior volume with receptacle installed.

NPT on top or bottom (if rotated). For other NPT configurations, contact customer service.

ANGLES

POLY ANGLE	
 30°	552M3

METAL ANGLE	
 0°	5K2M0
 30°	5K2M3

MISCELLANEOUS ACCESSORIES

FINGER DRAWPLATES	
	61-3A346 Set of Two (2) Recommended for easier connector closure.

PROTECTIVE CAP	
	31-1A426 For watertight seal, the male inlet must also be ordered with the "No Lockout Hole" option (-A155). For Male Devices Only.

RECEPTACLE LOCKING PIN	
	LP-843

Notes: For Zone 2 DR dimensions refer to DR dimensions on pgs 112-113.

DR50 Hazardous Location Plugs & Receptacles – 50A

Devices rated for hazardous locations are not returnable.

SP US Ratings

- Voltage**
600 VAC
- Current Interruption Capability**
Not for current interrupting
- Short Circuit Rating**
100kA Withstand
Testing was performed with RK1 current limiting fuses sized at 100% of the devices ampacity rating.
- Environmental Ratings**
Type 4X
- Temperature Range**
Min -40°F/Max 104°F
See pg 271 for temps below -15°F.
- Wiring Capacity**
Min 14 AWG Max 4 AWG
Aux Contacts - Max 14 AWG
Based on THHN wire sizes
- Applicable Standards**
CSA C22.2 No. 182.1-07
C22.2 No. 213-M1987
- Hazardous Ratings**
Class I, Division 2, Groups ABCD, T6
Class I, Zone 2, IIC

Receptacle (female)



Inlet (male)



! Don't forget to add installation accessories to your order

Hazardous Location DR50 lid is normally closed

Voltage	Polarity	Part # Poly	Part # Poly
120V	1P+N+G	35-34235-K16-xxx-HAZ	35-38235-K16-xxx-HAZ
120 208V	3P+N+G	35-34237-K16-xxx-HAZ	35-38237-K16-xxx-HAZ
125V	1P+N+G	35-34175-K07-xxx-HAZ	35-38175-K07-xxx-HAZ
125 250V	2P+N+G	35-34176-K07-xxx-HAZ	35-38176-K07-xxx-HAZ
208V	2P+G	35-34232-K16-xxx-HAZ	35-38232-K16-xxx-HAZ
208V	3P+G	35-34233-K16-xxx-HAZ	35-38233-K16-xxx-HAZ
250V	2P+G	35-34172-K07-xxx-HAZ	35-38172-K07-xxx-HAZ
250V	3P+G	35-34173-K07-xxx-HAZ	35-38173-K07-xxx-HAZ
277V	1P+N+G	35-34245-K04-xxx-HAZ	35-38245-K04-xxx-HAZ
277 480V	3P+N+G	35-34247-K04-xxx-HAZ	35-38247-K04-xxx-HAZ
347 600V	3P+N+G	35-34187-K14-xxx-HAZ	35-38187-K14-xxx-HAZ
480V	2P+G	35-34242-K04-xxx-HAZ	35-38242-K04-xxx-HAZ
480V	3P+G	35-34243-K04-xxx-HAZ	35-38243-K04-xxx-HAZ
600V	2P+G	35-34182-K14-xxx-HAZ	35-38182-K14-xxx-HAZ
600V	3P+G	35-34183-K14-xxx-HAZ	35-38183-K14-xxx-HAZ

The xxx represents any and all device options; if no options are needed, the xxx suffix should be omitted.

Part Number Example

480V DR50 + 2 aux contacts
DR50 recept 3P+G = 35-34243-K04-972-HAZ

480V DR50 with no options
DR50 recept 3P+G = 35-34243-K04-HAZ

Receptacle Options	Suffix #	Inlet Options	Suffix #
With 2 Auxiliary/Pilot Contacts	Recept # - 972	With 2 Auxiliary/Pilot Contacts	Inlet # - 972
With 3 Auxiliary/Pilot Contacts	Recept # - 973	With 3 Auxiliary/Pilot Contacts	Inlet # - 973
With 4 Auxiliary/Pilot Contacts	Recept # - 974	With 4 Auxiliary/Pilot Contacts	Inlet # - 974
Open Lid Configuration	Recept # - NO	With No Lockout Hole	Inlet # - A155

Feature Spotlight – Screw-Type Locking Pawl



! Listing Requirement
Users must tighten screw to lock the plug in the mated position

Zone 2/Division 2 DR50 receptacles feature a standard screw-type locking pawl. This required feature allows the user to lock the plug to the receptacle by tightening a screw on the pawl.

For added security, a lockout hole is included on the receptacle that enables the user to insert a 5/16" lock or locking pin to prevent the plug from being disconnected or to lock the receptacle lid closed.



5/16" hole for added security

! See pages 248-257 for detailed information on these options

INSTALLATION ACCESSORIES – SIZE 3

Accessories rated for hazardous locations are not returnable.

HANDLES

HANDLE w/NPT		Part # Poly	Part # Metal
	1/2"	553P0N05	5K3P0N05
	3/4"	553P0N07	5K3P0N07
	1"	553P0N10	5K3P0N10
	1 1/4"	553P0N12	5K3P0N12
POLY HANDLE w/Cable Range			
	.39 - 1.18"	553P0D30	

For available cord grips, see pg 179.

i

Cable Range	NPT	Cable Range	NPT
.312 - .625"	1/2"	.660 - 1.000"	1"
.438 - .812"	3/4"	.875 - 1.375"	1 1/4"

NPT sizes are determined by the cable diameter and third party cord grip.

BOXES

POLY ANGLE WITH METAL BOX w/NPT			
	30°	1/2"	753C3N05
	30°	3/4"	753C3N07
	30°	1"	753C3N10
	30°	1 1/4"	753C3N12
* 29.6 in ³			

* Interior volume with receptacle installed.

METAL ANGLE WITH METAL BOX w/NPT			
	30°	1/2"	7K3C3N05
	30°	3/4"	7K3C3N07
	30°	1"	7K3C3N10
	30°	1 1/4"	7K2C3N12
* 29.6 in ³			

* Interior volume with receptacle installed.

POLY ANGLE WITH LARGER METAL WALL BOX w/NPT			
	70°	1/2"	753C7N05
	70°	3/4"	753C7N07
	70°	1"	753C7N10
	70°	1 1/4"	753C7N12
	70°	1 1/2"	753C7N15
* 170.0 in ³			





* Interior volume with receptacle installed.

METAL ANGLE WITH METAL BOX w/NPT			
	70°	1/2"	7K3C7N05
	70°	3/4"	7K3C7N07
	70°	1"	7K3C7N10
	70°	1 1/4"	7K2C7N12
* 27.7 in ³			



* Interior volume with receptacle installed.

NPT on top or bottom (if rotated). For other NPT configurations, contact customer service.

ANGLES

POLY ANGLE		
	30°	553M3
METAL ANGLE		
	0°	5K3M0
	30°	5K3M3
	70°	5K3M7

MISCELLANEOUS ACCESSORIES

FINGER DRAWPLATES		
	61-6A346	Set of Two (2) Recommended for easier connector closure.
PROTECTIVE CAP		
	31-3A426	For watertight seal, the male inlet must also be ordered with the "No Lockout Hole" option (-A155). For Male Devices Only.
RECEPTACLE LOCKING PIN		
	LP-843	

HAZARDOUS LOCATION

Notes: For Zone 2 DR dimensions refer to DR dimensions on pgs 112-113.

DR250 Hazardous Location Plugs & Receptacles – 250A

Devices rated for hazardous locations are not returnable.

UL Ratings

- Voltage**
600 VAC
- Current Interruption Capability**
Not for current interrupting
- Short Circuit Rating**
10kA Withstand
Testing was performed with RK1 current limiting fuses sized at 100% of the devices ampacity rating.
- Environmental Ratings**
Type 4X
- Temperature Range**
Min -40°F/Max 104°F
See pg 271 for temps below -15°F.
- Wiring Capacity**
Min 4 AWG Max 4/0 AWG
Aux Contacts - Max 14 AWG
Based on THHN wire sizes
- Applicable Standards**
CSA C22.2 No. 182.1-07
C22.2 No. 213-M1987
- Hazardous Ratings**
Class I, Division 2, Groups ABCD, T6
Class I, Zone 2, IIC

Receptacle (female)

Inlet (male)

Easy Closing Mechanism



Standard Hazardous Location DR250 lid is normally closed and opens to 90°

! Don't forget to add installation accessories to your order

Voltage	Polarity	Part # Metal	Part # Metal
120V	1P+N+G	36-24235-K16-xxx-HAZ	36-28235-K16-xxx-HAZ
120 208V	3P+N+G	36-24237-K16-xxx-HAZ	36-28237-K16-xxx-HAZ
125V	1P+N+G	36-24035-K07-xxx-HAZ	36-28035-K07-xxx-HAZ
125 250V	2P+N+G	36-24036-K07-xxx-HAZ	36-28036-K07-xxx-HAZ
208V	2P+G	36-24232-K16-xxx-HAZ	36-28232-K16-xxx-HAZ
208V	3P+G	36-24233-K16-xxx-HAZ	36-28233-K16-xxx-HAZ
250V	2P+G	36-24032-K07-xxx-HAZ	36-28032-K07-xxx-HAZ
250V	3P+G	36-24033-K07-xxx-HAZ	36-28033-K07-xxx-HAZ
277V	1P+N+G	36-24245-K04-xxx-HAZ	36-28245-K04-xxx-HAZ
277 480V	3P+N+G	36-24247-K04-xxx-HAZ	36-28247-K04-xxx-HAZ
347 600V	3P+N+G	36-24027-K14-xxx-HAZ	36-28027-K14-xxx-HAZ
480V	2P+G	36-24242-K04-xxx-HAZ	36-28242-K04-xxx-HAZ
480V	3P+G	36-24243-K04-xxx-HAZ	36-28243-K04-xxx-HAZ
600V	2P+G	36-24022-K14-xxx-HAZ	36-28022-K14-xxx-HAZ
600V	3P+G	36-24023-K14-xxx-HAZ	36-28023-K14-xxx-HAZ

The xxx represents any and all device options; if no options are needed, the xxx suffix should be omitted.

Part Number Example

480V DR250 + 2 aux contacts

DR250 recept 3P+G = 36-24243-K04-972-HAZ

480V DR250 with no options

DR250 recept 3P+G = 36-24243-K04-HAZ

Receptacle Options	Suffix #	Inlet Options	Suffix #
With 2 Auxiliary/Pilot Contacts	Recept # - 972	With 2 Auxiliary/Pilot Contacts	Inlet # - 972
With 4 Auxiliary/Pilot Contacts	Recept # - 174	With 3 Auxiliary/Pilot Contacts	Inlet # - 174
With 6 Auxiliary/Pilot Contacts	Recept # - 976	With 4 Auxiliary/Pilot Contacts	Inlet # - 976
Normally Open Lid Configuration	Recept # - NO	With No Lockout Hole	Inlet # - A155
180° Opening Lid	Recept # - 180		

Feature Spotlight – Screw-Type Locking Pawl

! Listing Requirement
Users must tighten screw to lock the plug in the mated position



Zone 2/Division 2 DR250 receptacles feature a standard screw-type locking pawl. This required feature allows the user to lock the plug to the receptacle by tightening a screw on the pawl.

For added security, a lockout hole is included on the receptacle that enables the user to insert a 5/16" lock or locking pin to prevent the plug from being disconnected or to lock the receptacle lid closed.

5/16" hole for added security

! See pages 248-257 for detailed information on these options

INSTALLATION ACCESSORIES – SIZE 6

Accessories rated for hazardous locations are not returnable.

HANDLES

HANDLE w/NPT	Part # Metal
1"	5K6P0N10
1 1/4"	5K6P0N12
1 1/2"	5K6P0N15
2"	5K6P0N20
2 1/2"	5K6P0N25
3"	5K6P0N30



SANTOPRENE HANDLE w/Cable Range

.984 - 1.377"	556P0D35
1.377 - 1.771"	556P0D45
1.771 - 1.929"	556P0D49



IP 66/67

For available cord grips, see pg 179.

BOXES

METAL ANGLE WITH METAL BOX w/NPT	Part #
60° 1 1/2"	7K6C6N15
60° 2"	7K6C6N20
60° 2 1/2"	7K6C6N25



* 248.4 in³

* Interior volume with receptacle installed.

NPT on top or bottom (if rotated). For other NPT configurations, contact customer service.



Cable Range	NPT	Cable Range	NPT
.660 - 1.000"	1"	1.190 - 2.438"	2"
.875 - 1.375"	1 1/4"	2.062 - 2.438"	2 1/2"
.890 - 1.812"	1 1/2"	2.438 - 2.812"	3"

NPT sizes are determined by the cable diameter and third party cord grip.

ANGLES

METAL ANGLE	Part # Metal
0°	5K6M0



60°

5K6M6

MISCELLANEOUS ACCESSORIES

PROTECTIVE CAP



35-2A126

For watertight seal, the male inlet must also be ordered with the 'No Lockout Hole' option (-A155).
For Male Devices Only.

PADLOCKABLE PLUG CAP



DS2MC

For watertight seal, the male inlet must also be ordered with the 'No Lockout Hole' option (-A155).
Aluminum – For Male Devices Only.

CORD GRIP with MESH



see pg 178

RECEPTACLE LOCKING PIN



LP-843

HAZARDOUS LOCATION

Notes: For Zone 2 DR dimensions refer to DR dimensions on pgs 112-113.

Hazardous Location Plugs & Receptacles

20A – 200A Devices rated for hazardous locations are not returnable.

US Ratings

- Max Amperage & Voltage**
200A, 250 VDC
- Current Interruption Capability**
Not for current interrupting
- Environmental Ratings**
Type 4X
- Temperature Range**
Min -40°F/Max 104°F
See pg 271 for temps below -15°F.
- Wiring Capacity**
DSDC1 Min 14 AWG Max 8 AWG
DSDC3 Min 14 AWG Max 4 AWG
DSDC6 Min 10 AWG Max 2 AWG
DSDC9 Min 4 AWG Max 2/0 AWG
DSDC2 Min 4 AWG Max 4/0 AWG
Based on THHN wire sizes
- Certifications**
CSA C22.2 No. 182.1-07
CSA C22.2 No. 213-M1987
- Hazardous Ratings**
Class I, Division 2, Groups ABCD, T6
Class I, Zone 2, IIC

Receptacle (female)



Inlet (male)



! Don't forget to add installation accessories to your order

Voltage	Polarity	Part #		Part #	
		Poly	Metal	Poly	Metal
DSDC1	130V/20A 2P+G	35-14109-xxx-HAZ	-	35-18109-xxx-HAZ	-
DSDC3	130V/30A 2P+G	35-34109-xxx-HAZ	-	35-38109-xxx-HAZ	-
DSDC6	130V/60A 2P+G	35-64109-xxx-HAZ	36-64109-xxx-HAZ	35-68109-xxx-HAZ	36-68109-xxx-HAZ
DSDC9	130V/100A 2P+G	-	36-94109-xxx-HAZ	-	36-98109-xxx-HAZ
DSDC2	130V/200A 2P+G	-	36-24109-xxx-HAZ	-	36-28109-xxx-HAZ
DSDC1	250V/20A 2P+G	35-14209-xxx-HAZ	-	35-18209-xxx-HAZ	-
DSDC3	250V/30A 2P+G	35-34209-xxx-HAZ	-	35-38209-xxx-HAZ	-
DSDC6	250V/60A 2P+G	35-64209-xxx-HAZ	36-64209-xxx-HAZ	35-68209-xxx-HAZ	36-68209-xxx-HAZ
DSDC9	250V/100A 2P+G	-	36-94209-xxx-HAZ	-	36-98209-xxx-HAZ
DSDC2	250V/200A 2P+G	-	36-24209-xxx-HAZ	-	36-28209-xxx-HAZ

The xxx represents any and all device options; if no options are needed, the xxx suffix should be omitted.

Receptacle Options	Part #
Normally Open Lid	Recept # - N0
180° Opening Lid	Recept # - 180
<small>Metal casings only.</small>	
Inlet Options	Part #
With no Lockout Hole	Inlet # - A155

Feature Spotlight – Screw-Type Locking Pawl



Zone 2/Division 2 DSDC receptacles feature a standard screw-type locking pawl. This required feature allows the user to lock the plug to the receptacle by tightening a screw on the pawl.

For added security, a lockout hole is included on the receptacle that enables the user to insert a 5/16" lock or locking pin to prevent the plug from being disconnected or to lock the receptacle lid closed.

Part Number Example

250V DSDC6 + 180° Opening Lid
DSDC6 Metal recept 2P+G = 36-64209-180-HAZ

250V DSDC6 with no options
DSDC6 Metal recept 2P+G = 36-64209-HAZ

! See pages 248-257 for detailed information on these options

INSTALLATION ACCESSORIES

Unless indicated otherwise, accessories can be used with either poly or metal plugs and receptacles.

HANDLES



Poly Handle



Poly Handle

For Zone 2 DSDC dimensions use the cross reference chart below and refer to DS dimensions on pgs 54-55.

	Cable Range Poly Handle		1/2" NPT	3/4" NPT	1" NPT	1 1/4" NPT	1 1/2" NPT
	DSDC1	.20 - .83	552P0D21	552P0N05	552P0N07	552P0N10	552P0N12
DSDC3	.39 - 1.18	553P0D30	553P0N05	553P0N07	553P0N10	553P0N12	-
DSDC6	.51 - 1.38	554P0D35	554P0N05	554P0N07	554P0N10	554P0N12	554P0N15

Dimensions	
DSDC1	same as DS20
DSDC3	same as DS30
DSDC6	same as DS60
DSDC9	same as DS100
DSDC2	same as DS200



Metal Handle

DSDC1, 3, 6 shown



Metal Handle

DSDC9, 2 shown

	1/2" NPT	3/4" NPT	1" NPT	1 1/4" NPT	1 1/2" NPT	2" NPT	2 1/2" NPT	3" NPT
DSDC1	5K2P0N05	5K2P0N07	5K2P0N10	5K2P0N12	-	-	-	-
DSDC3	5K3P0N05	5K3P0N07	5K3P0N10	5K3P0N12	-	-	-	-
DSDC6	5K4P0N05	5K4P0N07	5K4P0N10	5K4P0N12	5K4P0N15	-	-	-
DSDC9	-	5K5P0N07	5K5P0N10	5K5P0N12	5K5P0N15	5K5P0N20	-	-
DSDC2	-	-	5K6P0N10	5K6P0N12	5K6P0N15	5K6P0N20	5K6P0N25	5K6P0N30

i For available cord grips, see pgs 179.

BOXES



Poly Angle 30° with Metal Box

DSDC1, 3, 6 shown



Metal Angle 30° with Metal Box (DSDC2 60°)

DSDC1, 3, 6 shown



DSDC9, 2 shown

	Poly Angle 30° with Metal Box						Metal Angle 30° with Metal Box (DSDC2 60°)						
	1/2" NPT	3/4" NPT	1" NPT	1 1/4" NPT	1 1/2" NPT	2" NPT	1/2" NPT	3/4" NPT	1" NPT	1 1/4" NPT	1 1/2" NPT	2" NPT	2 1/2" NPT
DSDC1	752C3N05	752C3N07	752C3N10	752C3N12	-	-	7K2C3N05	7K2C3N07	7K2C3N10	7K2C3N12	-	-	-
DSDC3	753C3N05	753C3N07	753C3N10	753C3N12	-	-	7K3C3N05	7K3C3N07	7K3C3N10	7K3C3N12	-	-	-
DSDC6	-	-	754C3N10	754C3N12	754C3N15	754C3N20	-	-	7K4C3N10	7K4C3N12	7K4C3N15	7K4C3N20	-
DSDC9	-	-	-	-	-	-	-	-	-	7K5C3N12	7K5C3N15	7K5C3N20	7K5C3N25
DSDC2	-	-	-	-	-	-	-	-	-	-	7K6C6N15	7K6C6N20	7K6C6N25



Poly Angle 70° with Larger Metal Wall Box w/NPT



Metal Angle 70° with Metal Box w/NPT

	Poly Angle 70° with Larger Metal Wall Box w/NPT					Metal Angle 70° with Metal Box w/NPT				
	1/2" NPT	3/4" NPT	1" NPT	1 1/4" NPT	1 1/2" NPT	1" NPT	1 1/4" NPT	1 1/2" NPT	2" NPT	2 1/2" NPT
DSDC1	752C7N05	752C7N07	752C7N10	752C7N12	752C7N15	DSDC6	7K4C7N10	7K4C7N12	7K4C7N15	7K4C7N20
DSDC3	753C7N05	753C7N07	753C7N10	753C7N12	753C7N15	DSDC9	7K5C7N12	7K5C7N15	7K5C7N20	7K5C7N25

ANGLES



Poly 30° Angle



Metal 30° Angle



Metal 70° Angle



Metal Straight Adapter

	Poly 30° Angle	Metal 30° Angle	Metal 70° Angle	Metal Straight Adapter
DSDC1	552M3	5K2M3	-	5K2M0
DSDC3	553M3	5K3M3	5K3M7	5K3M0
DSDC6	554M3	5K4M3	5K4M7	5K4M0
DSDC9	-	5K5M3	5K5M7	5K5M0
DSDC2	-	5K6M6 (60°)	-	5K6M0



* Set of Two (2)



For Male Devices Only



For Male Devices Only



MISC. ACCESSORIES

	Finger Drawplates	Protective Cap	Padlockable Cap Aluminum	Cord Grip with Mesh	Receptacle Locking Pin
DSDC1	61-3A346	31-1A426	-	-	LP-843
DSDC3	61-6A346	31-3A426	-	-	LP-843
DSDC6	31-6A346	31-6A426	DS6MC	-	LP-843
DSDC9	**	35-9A126	DS9MC	see pg 179	LP-843
DSDC2	**	35-2A126	DS2MC	see pg 179	LP-843

* Recommended for easier connector closure.

** An easy closing mechanism is standard on DSDC9 and DSDC2.

HAZARDOUS LOCATION

DX Hazardous Location plug and receptacle



Main Advantages

- ▶ Rugged Construction, cost effective design
- ▶ Rated for Zone 1 and Zone 21 applications



- | | | | |
|----------------------------|--------|--------------|--------|
| ▶ Features & Ratings | p. 227 | ▶ DX3 | p. 231 |
| ▶ Certifications & Testing | p. 228 | ▶ DX6 | p. 232 |
| ▶ Operation | p. 229 | ▶ DX9 | p. 233 |
| ▶ DX1 | p. 230 | ▶ Dimensions | p. 234 |

PRODUCT FEATURES



Dead Front

The 'dead' load-side switching contacts block access to the receptacle and are locked in the open position until an appropriate mating plug is fully inserted. This prevents unintended access to live parts and ensures user safety.

ON & OFF Positions when Mated

The operation of the switching mechanism allows the circuit to be disconnected without removing the plug.

Normally Closed Receptacle Lid

The lid automatically closes to a pre-latched position when the plug is removed. This prevents the entry of dust and debris. The lid must be manually latched to maintain IP 65 protection.

Heavy Duty Aluminum Casing

All components are enclosed in rugged copper free aluminum housings for maximum durability and protection.

Explosion Proof Chamber

The making and breaking of the contacts occurs in an explosion proof chamber, which is specially designed to withstand the pressure generated during arcing and to ensure that no arc, flame or other ignition source can be communicated with the external environment.

Spring Operated Switching Mechanism

An integral switching mechanism ensures quick-make, quick-break operation, independent of the motion of the user.

Silver-Nickel Butt Contacts

Contact design provides a superior connection, with maximum conductivity, the ability to withstand arcing and oxidation, excellent wear resistance, and a long operating life. A wiping motion during operation also provides a self-cleaning action.

Operating Instructions



When a DX is connected there is total safety.



Pressing the pawl while turning the plug about 30° counterclockwise causes the circuit to be broken.



Press the pawl while withdrawing the plug from the receptacle. This is done in complete safety because the circuit is already dead.



The plug and receptacle are separated. The safety shutter prevents access to live parts.

5 To reconnect, insert plug into receptacle fully, then twist the plug approximately 30° clockwise to make the circuit.

General Ratings

Amperage	20 to 125A
Voltage	750 VAC
Frequency	50-400 Hz
Environmental	IP65
Temperature	min -13°F/max 140°F* [DX1/DX3] min -40°F/max 140°F* [DX6/DX9]

Highlighted Feature

Dead Front

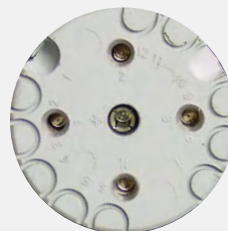

The dead front on the DX receptacle provides protection from accidental tool and wire insertion.

DX Certifications

Hazardous Duty Certification

ATEX and IECEx



II 2 G/D Ex de IIC tD A21

- II** – Indicates suitability for installation in surface applications (as opposed to underground mine applications).
- 2** – Indicates suitability for use where a high level of protection is required and where the presence of an explosive atmosphere is likely to occur (Zone 1 and Zone 21 environments).
- G/D** – Indicates suitability for installation in areas that may contain flammable gases, vapors/mists, or dusts.
- Ex de** – Protection method for gas atmospheres indicating that explosion protection is provided with (e) increased safety in the conductor termination area, and (d) explosion proof chambers for making and breaking the current that can withstand the pressure of internal ignition and that prevent arcs, flame or other ignition events from being communicated to the surrounding atmosphere.
- IIC** – Indicates suitability for installation in areas where exposure to any type of gas, including the most dangerous subdivision C gases may occur.
- tD** – Protection method for dust atmospheres indicating that explosion protection is provided by the type of enclosure (casing) used.
- A21** – Indicates a dust tight enclosure (IP6x) is used to achieve a Zone 21 rating.

ATEX & IECEx certification was performed by LCIE.

* Temperature ratings vary depending on product and ambient temperature. See specific product section for temperature ratings.

Electrical Performance Testing

Key Performance Tests Passed				
Model	Mechanical Endurance	Electrical Endurance ¹	Overload Testing ²	Dielectric Test
DX1	-	5000 Operations	50 Operations	2 x V (rated) + 1000V
DX3	1000 Cycles	1000 Operations	50 Operations	2 x V (rated) + 1000V
DX6	1000 Cycles	1000 Operations	50 Operations	2 x V (rated) + 1000V
DX9	1000 Cycles	1000 Operations	50 Operations	2 x V (rated) + 1000V

¹ @ 100% of rated current and voltage and 0.6 power factor.

² @ 125% of rated current, 110% of rated voltage, & 0.6 power factor.

DX complies with

ATEX	2014/35/EV Directive
IEC/EN	60079-0
	60079-1
	60079-7
	60079-31

DX Operation

Connection

1



Insertion of the Plug

As the plug contact is inserted, it engages and depresses the 'dead' switching contact.

This releases the locking mechanism. The switching contact is free to operate.

2



Charging the Operating Spring

Clockwise rotation of the inserted plug winds the operating spring and rotates the switching contact into position to engage with the live receptacle contact.

3



Making the Circuit

With the final few degrees of rotation, the switching contact is released and force from the spring quickly drives it into engagement with the live receptacle contact.

Disconnection



After depressing the pawl, the plug is rotated in a counter-clockwise direction. This frees the switching contact for operation and the release of the remaining spring tension causes a quick breaking of the contacts. The plug may now be removed, if desired.



Receptacle with Plug Disconnected

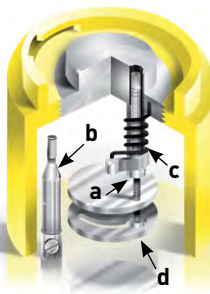

- a. **Switching Contact**
Shown in the open (dead) position
- b. **'Live' Receptacle Contact**
Accessibility is denied
- c. **Operating Spring**
Shown with tension released
- d. **Mechanical Locking Device**
Blocks contact operation

DX1 Hazardous Location Plugs & Receptacles – 20A

Devices rated for hazardous locations are not returnable.

Ratings

- **Max Amperage & Voltage**
20A, 750 VAC
- **Environmental Ratings**
IP65
- **Temperature Range**
Min -13°F/Max 140°F
- **Wiring Capacity**
Min 14 AWG Max 8 AWG
* Based on THHN wire sizes
- **Applicable Standards**
ATEX, IECEx
- **Hazardous Location Ratings**

MARECHAL ELECTRIC MAROMME
II2 G/D Ex de IIC tD A21
-25°C ≤ Ta ≤ +60°C T5 T84°C
-25°C ≤ Ta ≤ +50°C T6 T74°C
IECEx LCI 09.0014/LCIE 05 ATEX 6127

XXX Suffix / Cable Range

XXX (Suffix #)	Cable Range
-20M	.31" - .51"
-25M	.35" - .63"

XX Suffix / NPT Size

NPT Thread Size	XX (Suffix #)
1/2"	-12
3/4"	-34
1"	-1

NPT sizes are determined by the cable diameter and third party cord grip.

Accessories

Protective Cap

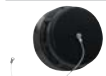

For Male
Devices Only

DX1 26-2A126

Metal Wall Box



NPT	Part #
1/2"	26-2A023-12
3/4"	26-2A023-34
1"	26-2A023-1

Plug
(Male inlet w/handle)



Inlet w/cap on box
(Male)



or

North American Configurations

Voltage	Polarity	Part #	
		Metal	Metal
120V	1P+N+G	26-21165-XXX	26-26165-XX
125V	1P+N+G	26-21075-XXX	26-26075-XX
208V	2P+G	26-21162-XXX	26-26162-XX
208V	3P+G	26-21163-XXX	26-26163-XX
208V	3P+N+G	26-21167-XXX	26-26167-XX
250V	2P+G	26-21072-XXX	26-26072-XX
250V	3P+G	26-21073-XXX	26-26073-XX
250V	2P+N+G	26-21076-XXX	26-26076-XX
277V	1P+N+G	26-21045-XXX	26-26045-XX
480V	2P+G	26-21042-XXX	26-26042-XX
480V	3P+G	26-21043-XXX	26-26043-XX
480V	3P+N+G	26-21047-XXX	26-26047-XX
600V	3P+G	26-21143-XXX	26-26143-XX

For international configurations (IEC/CE) visit meltric.com/international-catalog or contact customer service at 800.433.7642.

Connector
(female recept w/handle)



Receptacle on box
(female)



Receptacle
(female)



or

or

North American Configurations

Voltage	Polarity	Part #		
		Metal	Metal	Metal
120V	1P+N+G	26-23165-XXX	26-20165-XX	26-24165
125V	1P+N+G	26-23075-XXX	26-20075-XX	26-24075
208V	2P+G	26-23162-XXX	26-20162-XX	26-24162
208V	3P+G	26-23163-XXX	26-20163-XX	26-24163
208V	3P+N+G	26-23167-XXX	26-20167-XX	26-24167
250V	2P+G	26-23072-XXX	26-20072-XX	26-24072
250V	3P+G	26-23073-XXX	26-20073-XX	26-24073
250V	2P+N+G	26-23076-XXX	26-20076-XX	26-24076
277V	1P+N+G	26-23045-XXX	26-20045-XX	26-24045
480V	2P+G	26-23042-XXX	26-20042-XX	26-24042
480V	3P+G	26-23043-XXX	26-20043-XX	26-24043
480V	3P+N+G	26-23047-XXX	26-20047-XX	26-24047
600V	3P+G	26-23143-XXX	26-20143-XX	26-24143

For international configurations (IEC/CE) visit meltric.com/international-catalog or contact customer service at 800.433.7642.

DX3 Hazardous Location Plugs & Receptacles – 32A

Devices rated for hazardous locations are not returnable.

Plug (Male inlet w/handle) **or** **Inlet w/cap on box** (Male)



North American Configurations

Voltage	Polarity	Part # Metal	Part # Metal
120V	1P+N+G	26-31165-XXX	26-36165-XX
125V	1P+N+G	26-31075-XXX	26-36075-XX
208V	2P+G	26-31162-XXX	26-36162-XX
208V	3P+G	26-31163-XXX	26-36163-XX
208V	3P+N+G	26-31167-XXX	26-36167-XX
250V	2P+G	26-31072-XXX	26-36072-XX
250V	3P+G	26-31073-XXX	26-36073-XX
250V	2P+N+G	26-31076-XXX	26-36076-XX
277V	1P+N+G	26-31045-XXX	26-36045-XX
480V	2P+G	26-31042-XXX	26-36042-XX
480V	3P+G	26-31043-XXX	26-36043-XX
480V	3P+N+G	26-31047-XXX	26-36047-XX
600V	3P+G	26-31143-XXX	26-36143-XX

For international configurations (IEC/CE) visit meltric.com/international-catalog or contact customer service at 800.433.7642.

Connector (female recept w/handle) **or** **Receptacle on box** (female) **or** **Receptacle** (female)



North American Configurations

Voltage	Polarity	Part # Metal	Part # Metal	Part # Metal
120V	1P+N+G	26-33165-XXX	26-30165-XX	26-34165
125V	1P+N+G	26-33075-XXX	26-30075-XX	26-34075
208V	2P+G	26-33162-XXX	26-30162-XX	26-34162
208V	3P+G	26-33163-XXX	26-30163-XX	26-34163
208V	3P+N+G	26-33167-XXX	26-30167-XX	26-34167
250V	2P+G	26-33072-XXX	26-30072-XX	26-34072
250V	3P+G	26-33073-XXX	26-30073-XX	26-34073
250V	2P+N+G	26-33076-XXX	26-30076-XX	26-34076
277V	1P+N+G	26-33045-XXX	26-30045-XX	26-34045
480V	2P+G	26-33042-XXX	26-30042-XX	26-34042
480V	3P+G	26-33043-XXX	26-30043-XX	26-34043
480V	3P+N+G	26-33047-XXX	26-30047-XX	26-34047
600V	3P+G	26-33143-XXX	26-30143-XX	26-34143

For international configurations (IEC/CE) visit meltric.com/international-catalog or contact customer service at 800.433.7642.

Ratings

- **Max Amperage & Voltage**
32A, 750 VAC
- **Environmental Ratings**
IP65
- **Temperature Range**
Min -13°F/Max 140°F
- **Wiring Capacity**
Min 14 AWG Max 8 AWG
* Based on THHN wire sizes
- **Applicable Standards**
ATEX, IECEx
- **Hazardous Location Ratings**

MARECHAL ELECTRIC MAROMME
I12 G/D Ex de IIC tD A21
-25°C ≤ Ta ≤ +60°C T5 T84°C
-25°C ≤ Ta ≤ +50°C T6 T74°C
IECEx LCI 09.0014/LCIE 05 ATEX 6127

XXX Suffix/Cable Range

XXX (Suffix #)	Cable Range
-25M	.35" - .63"
-32M	.47" - .83"

XX Suffix/NPT Size

NPT Thread Size	XX (Suffix #)
1/2"	-12
3/4"	-34
1"	-1

NPT sizes are determined by the cable diameter and third party cord grip.

Accessories

Protective Cap



DX3 26-3A126

Metal Wall Box



NPT	Part #
1/2"	26-3A023-12
3/4"	26-3A023-34
1"	26-3A023-1

DX6 Hazardous Location Plugs & Receptacles – 63A

Devices rated for hazardous locations are not returnable.

Ratings

- **Max Amperage & Voltage**
63A, 750 VAC
- **Environmental Ratings**
IP65/IP66
- **Temperature Range**
Min -40°F/Max 140°F
- **Wiring Capacity**
Min 6 AWG Max 1/0 AWG
* Based on THHN wire sizes
- **Applicable Standards**
ATEX, IECEx
- **Hazardous Location Ratings**

MARECHAL ELECTRIC MAROMME
II2 G/D Ex de IIC tD A21
-40°C ≤ Ta ≤ +60°C T5 T90°C
-40°C ≤ Ta ≤ +50°C T6 T80°C
IECEx LCI 09.0015/LCIE 04 ATEX 6038

XXX Suffix / Cable Range

XXX (Suffix #)	Cable Range
-32M	.47" - .83"
-40M	.63" - 1.06"

XX Suffix / NPT Size

NPT Thread Size	XX (Suffix #)
1"	-1
1 1/4"	-114
1 1/2"	-112
2"	-2

NPT sizes are determined by the cable diameter and third party cord grip.

Accessories

Protective Cap



For Male Devices Only

DX6 26-6A126

Metal Wall Box



NPT	Part #
1"	26-6A023-1
1 1/4"	26-6A023-114
1 1/2"	26-6A023-112
2"	26-6A023-2

Plug
(Male inlet w/handle)



Inlet w/cap on box
(Male)



or

North American Configurations

Voltage	Polarity	Part #	
		Metal	Metal
120V	1P+N+G	26-61165-XXX	26-66165-XX
125V	1P+N+G	26-61075-XXX	26-66075-XX
208V	2P+G	26-61162-XXX	26-66162-XX
208V	3P+G	26-61163-XXX	26-66163-XX
208V	3P+N+G	26-61167-XXX	26-66167-XX
250V	2P+G	26-61072-XXX	26-66072-XX
250V	3P+G	26-61073-XXX	26-66073-XX
250V	2P+N+G	26-61076-XXX	26-66076-XX
277V	1P+N+G	26-61045-XXX	26-66045-XX
480V	2P+G	26-61042-XXX	26-66042-XX
480V	3P+G	26-61043-XXX	26-66043-XX
480V	3P+N+G	26-61047-XXX	26-66047-XX
600V	3P+G	26-61143-XXX	26-66143-XX

For international configurations (IEC/CE) visit meltric.com/international-catalog or contact customer service at 800.433.7642.

Connector
(female recept w/handle)



Receptacle on box
(female)



Receptacle
(female)



or

or

North American Configurations

Voltage	Polarity	Part #		
		Metal	Metal	Metal
120V	1P+N+G	26-63165-XXX	26-60165-XX	26-64165
125V	1P+N+G	26-63075-XXX	26-60075-XX	26-64075
208V	2P+G	26-63162-XXX	26-60162-XX	26-64162
208V	3P+G	26-63163-XXX	26-60163-XX	26-64163
208V	3P+N+G	26-63167-XXX	26-60167-XX	26-64167
250V	2P+G	26-63072-XXX	26-60072-XX	26-64072
250V	3P+G	26-63073-XXX	26-60073-XX	26-64073
250V	2P+N+G	26-63076-XXX	26-60076-XX	26-64076
277V	1P+N+G	26-63045-XXX	26-60045-XX	26-64045
480V	2P+G	26-63042-XXX	26-60042-XX	26-64042
480V	3P+G	26-63043-XXX	26-60043-XX	26-64043
480V	3P+N+G	26-63047-XXX	26-60047-XX	26-64047
600V	3P+G	26-63143-XXX	26-60143-XX	26-64143

For international configurations (IEC/CE) visit meltric.com/international-catalog or contact customer service at 800.433.7642.

DX9 Hazardous Location Plugs & Receptacles – 125A

Devices rated for hazardous locations are not returnable.

Plug
(Male inlet w/handle)



or

Inlet w/cap on box
(Male)



North American Configurations

Voltage	Polarity	Part # Metal	Part # Metal
120V	1P+N+G	26-91165-XXX	26-96165-XX
125V	1P+N+G	26-91075-XXX	26-96075-XX
208V	2P+G	26-91162-XXX	26-96162-XX
208V	3P+G	26-91163-XXX	26-96163-XX
208V	3P+N+G	26-91167-XXX	26-96167-XX
250V	2P+G	26-91072-XXX	26-96072-XX
250V	3P+G	26-91073-XXX	26-96073-XX
250V	2P+N+G	26-91076-XXX	26-96076-XX
277V	1P+N+G	26-91045-XXX	26-96045-XX
480V	2P+G	26-91042-XXX	26-96042-XX
480V	3P+G	26-91043-XXX	26-96043-XX
480V	3P+N+G	26-91047-XXX	26-96047-XX
600V	3P+G	26-91143-XXX	26-96143-XX

For international configurations (IEC/CE) visit meltric.com/international-catalog or contact customer service at 800.433.7642.

Connector
(female recept w/handle)



or

Receptacle on box
(female)



or

Receptacle
(female)



North American Configurations

Voltage	Polarity	Part # Metal	Part # Metal	Part # Metal
120V	1P+N+G	26-93165-XXX	26-90165-XX	26-94165
125V	1P+N+G	26-93075-XXX	26-90075-XX	26-94075
208V	2P+G	26-93162-XXX	26-90162-XX	26-94162
208V	3P+G	26-93163-XXX	26-90163-XX	26-94163
208V	3P+N+G	26-93167-XXX	26-90167-XX	26-94167
250V	2P+G	26-93072-XXX	26-90072-XX	26-94072
250V	3P+G	26-93073-XXX	26-90073-XX	26-94073
250V	2P+N+G	26-93076-XXX	26-90076-XX	26-94076
277V	1P+N+G	26-93045-XXX	26-90045-XX	26-94045
480V	2P+G	26-93042-XXX	26-90042-XX	26-94042
480V	3P+G	26-93043-XXX	26-90043-XX	26-94043
480V	3P+N+G	26-93047-XXX	26-90047-XX	26-94047
600V	3P+G	26-93143-XXX	26-90143-XX	26-94143

For international configurations (IEC/CE) visit meltric.com/international-catalog or contact customer service at 800.433.7642.

Ratings

- **Max Amperage & Voltage**
125A, 750 VAC
- **Environmental Ratings**
IP65/IP66
- **Temperature Range**
Min -40°F/Max 140°F
- **Wiring Capacity**
Min 2 AWG Max 2/0 AWG
* Based on THHN wire sizes
- **Applicable Standards**
ATEX, IECEx
- **Hazardous Location Ratings**

MARECHAL ELECTRIC MAROMME
II2 G/D Ex de IIC tD A21
-40°C ≤ Ta ≤ +60°C T5 T90°C
-40°C ≤ Ta ≤ +50°C T6 T80°C
IECEX LCI 09.0015/LCIE 04 ATEX 6038

XXX Suffix/Cable Range

XXX (Suffix #)	Cable Range
-32M	.47" - .83"
-40M	.63" - 1.06"
-50M	.91" - 1.38"
-63M	1.42" - 1.89"

NPT Thread Size	XX (Suffix #)
1"	-1
1 1/4"	-114
1 1/2"	-112
2"	-2

NPT sizes are determined by the cable diameter and third party cord grip.

Accessories

Protective Cap



For Male Devices Only

DX9

26-9A126

Metal Wall Box



NPT

Part #

1"

26-9A023-1

1 1/4"

26-9A023-114

1 1/2"

26-9A023-112

2"

26-9A023-2

DX DIMENSIONS Inlet – Provided in inches

Dimensions are for reference only and may change depending on accessories used. For precise dimensions contact MELTRIC Engineering.

Plug

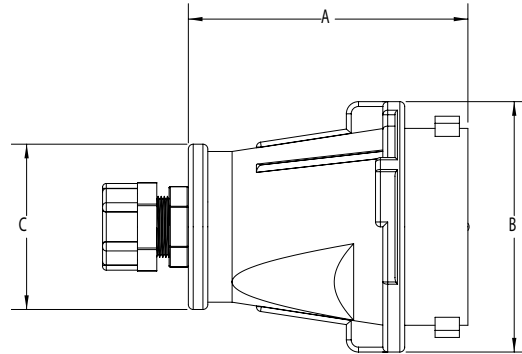

PRODUCT	A	B	C
DX20/DX30	4.53	4.06	2.68
DX60/DX100	8.66	5.75	3.94

Receptacle

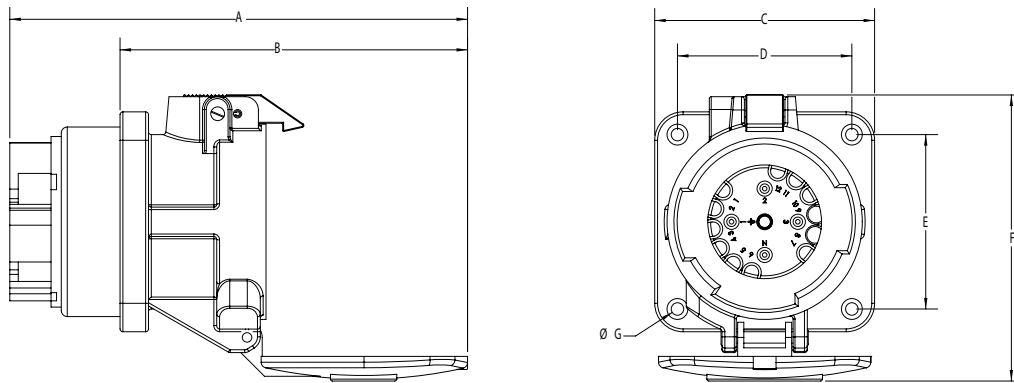

PRODUCT	A	B	C	D	E	F	øG
DX20/DX30	9.51	7.22	4.57	3.62	3.62	5.94	0.26
DX60/DX100	15.3	11.67	6.3	4.8	4.8	7.95	0.35



Wall Box/ Receptacle/Plug

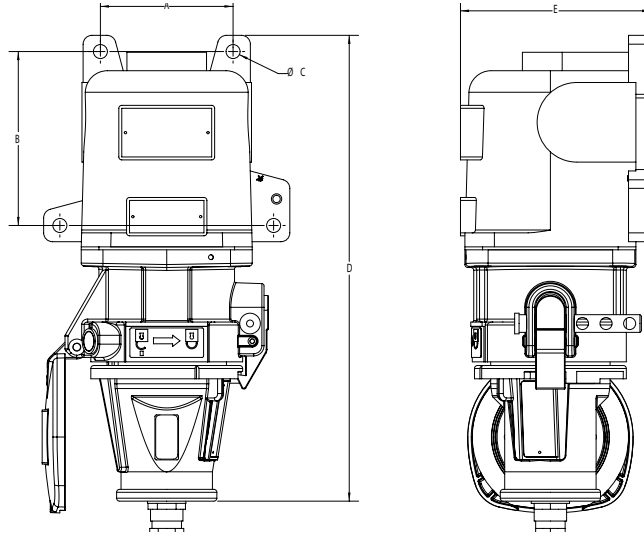

PRODUCT	A	B	C	D	øE
DX20/DX30	3.54	4.65	0.37	12.44	5.08
DX60/DX100	5.12	6.81	0.39	19.06	6.5

Plug/Connector

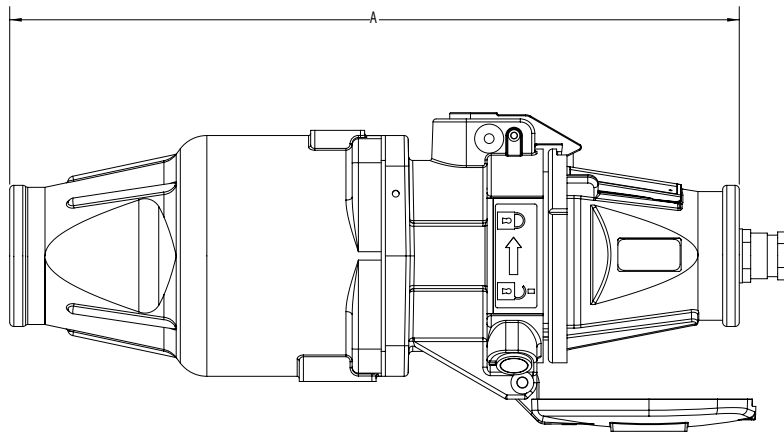

PRODUCT	A
DX20/DX30	13.84
DX60/DX100	21.14



MULTIPIN

Plugs & Receptacles



Multipin plugs and receptacles rated for hazardous environments. Industrial duty casings withstand harsh environments and rough handling.



PXM12C P. 238

MULTIPIN CONNECTORS

- ATEX rated
- Up to 12 contacts
- Compact design
- Crimped or soldered contact



DXN25C P. 240

MULTIPIN CONNECTORS

- ATEX rated
- Up to 25 contacts
- Corrosion-free metal casing
- Crimped or soldered contacts



DXN37C P. 240

MULTIPIN CONNECTORS

- ATEX rated
- Up to 37 contacts
- Corrosion-free metal casing
- Crimped or soldered contacts



MULTIPIN PXN12c

PRODUCT FEATURES



Metal Casing

Provides excellent durability and protection.

IP65/IP66 Watertightness

Environmental rating is achieved as soon as the plug is latched to the receptacle. There is no additional rings to tighten.

Lid

Provides additional protection from harsh environments.

Recessed Contacts

Provides IP2X protection from live electrical parts.

Locking Provision

Turn triangular screw with special tool (provided) to prevent plug removal.

Spring Loaded Butt-Style Contacts

Ensures optimal contact force and superior electrical performance over thousands of operations.

Silver-Nickel Contacts

Silver-nickel contact material provides superior conductivity, durability and corrosion resistance.

Hazardous Location Listings

ATEX

II 2 GD Exe IIIC Gb Ex tb IIIC Db
 Suitable for Zone 1 & 2 (gas) 21 & 22 (dust)
 Ex ia or ib IICT6 Gb
 IECEx LCIE 14.0041X/LCIE 07 ATEX 6070X

Highlighted Feature

- Crimped Contacts**
 PXN12c devices now feature contacts that can be crimped or soldered. Each device is supplied with 13 contacts so that the product can be set up to suit application needs.

Simple Assembly and Disassembly

DSN37c shown

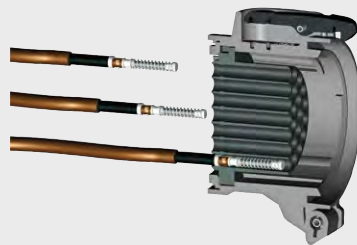

Assembly

To insert contacts when they have been wired is simple. Push wired contact into rear of insulator until it stops to complete the installation.

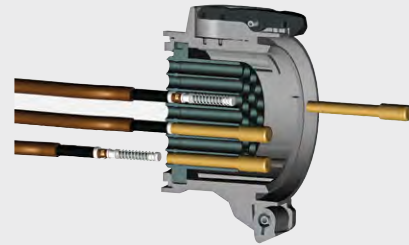

Disassembly

To remove, use the tool provided. Push tool from front onto contact until tool stops. Contact is then released at rear of insulator.

PXN12c Hazardous Location Multipin – 10A

Devices rated for hazardous locations are not returnable.

Connector
(female recept w/handle)



or

Receptacle/Angle
(female)



or

Recept/Angle/Box
(female)



North American UL/CSA Configurations

Voltage	Polarity	Cable Range	Part # Metal	Part # Metal	Part # Metal
220V	11P+G	.35 - .63"	06-A3001-25M	06-A7001	06-A0001-25M
220V	11P+G	.47 - .82"	06-A3001	06-A7001	06-A0001

For international configurations (IEC/CE) visit meltric.com/international-catalog or contact customer service at 800.433.7642.

Plug
(male inlet w/handle)



or

Inlet/Angle
(male)



or

Inlet/Angle/Box
(male)



North American UL/CSA Configurations

Voltage	Polarity	Cable Range	Part # Metal	Part # Metal	Part # Metal
220V	11P+G	.35 - .63"	06-A1001-25M	06-A9001	06-A6001-25M
220V	11P+G	.47 - .82"	06-A1001	06-A9001	06-A6001

For international configurations (IEC/CE) visit meltric.com/international-catalog or contact customer service at 800.433.7642.

Ratings

- **Voltage**
220 VAC or VDC
- **Amperage Ratings**
10A Not for disconnection of a live circuit
- **Environmental Ratings**
IP65/IP66
- **Temperature Range**
Min -40°F/Max 131°F
- **Wiring Capacity**
Min 16 AWG Max 14 AWG
* Based on THHN wiring connection type solder
- **Terminal Type**
Solder/Crimp
- **Applicable Standards**
ATEX, IECEx

ACCESSORIES

PROTECTIVE CAP



01-2A126

EUROPEAN CRIMPING TOOL



61-CA500

BAG OF 13 FEMALE CONTACTS



01-AA213

Includes insulation sleeves and ferrules

MULTI-CONTACT REMOVAL TOOL



61-CA593

CRIMPER TOOL (Greenlee or equal)



4CN30

BAG OF 13 MALE CONTACTS



01-AA113

Includes insulation sleeves and ferrules

PXN12c DIMENSIONS – Provided in inches

Dimensions are for reference only and may change depending on accessories used. For precise dimensions contact MELTRIC Engineering.

Plug

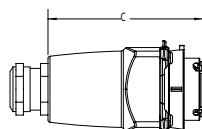
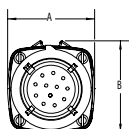

Wall box/angle/receptacle/plug

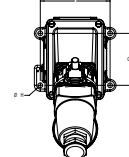
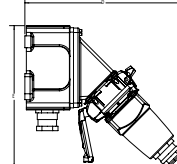

PRODUCT	A	B	C	D	E	F	G	H
PXN12c	2.3	2.42	4.09	8.37	7.54	3.7	2.76	0.26

MULTIPIN DXN25c/DXN37c

PRODUCT FEATURES



Locking Provision

For insertion of locking pin (or padlock) to prevent inadvertent disconnection.

Metal Casing

Provides excellent durability and protection.

Lid

Provides additional protection from harsh environments.

Silver-Nickel Contacts

Silver-nickel contact material provides superior conductivity, durability and corrosion resistance.

Recessed Contacts

Provides IP2X protection from live electrical parts.

Spring Loaded Butt-Style Contacts

Ensures optimal contact force and superior electrical performance over thousands of operations.

IP66/IP67 Watertightness

Environmental rating is achieved as soon as the plug is latched to the receptacle. There is no additional ring to tighten.

Hazardous Location Listings

ATEX	
	II 2 GD Ex e IIC Gb Ex tb IIIC Db Suitable for Zone 1 & 2 (gas) 21 & 22 (dust) Ex ia or ib IIC T6 Gb
DXN25c	-40°C ≤ Ta ≤ 60°C T5 T71°C -40°C ≤ Ta ≤ 40°C T6 T51 °C IECEx LCIE 14.00.40X/LCIE 09 ATEX 3050X
DXN37c	-40°C ≤ Ta ≤ 55°C T5 T76°C -40°C ≤ Ta ≤ 40°C T6 T56 °C IECEx LCIE 14.0038X/LCIE 07 ATEX 6071X

Highlighted Feature

- **Crimped Contacts**
DXN25c/DXN37c devices now feature contacts that can be crimped or soldered. Each device is supplied with 26 or 39 contacts so that the product can be set up to suit application needs.

Simple Assembly and Disassembly

DSN37c shown

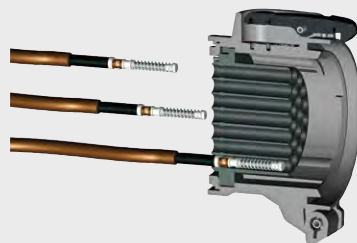

Assembly

To insert contacts when they have been wired is simple. Push wired contact into rear of insulator until it stops to complete the installation.

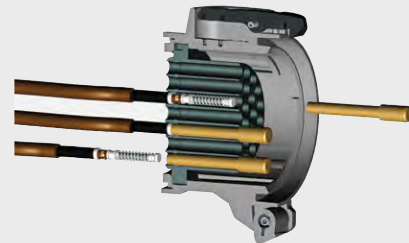

Disassembly

To remove, use the tool provided. Push tool from front onto contact until tool stops. Contact is then released at rear of insulator.

DXN25C/37C Hazardous Location Multipin – 10A

Devices rated for hazardous locations are not returnable.

Connector
(female recept w/handle)



Receptacle/Angle (female) **Recept/Angle/Box** (female)



North American UL/CSA Configurations

Voltage	Polarity	Cable Range	Part # Metal	Part # Metal	Part # Metal
440V	24P+G	.47 - .825"	36-D3002-32M	36-D7002	36-D0002-32M
440V	24P+G	.63 - 1.063"	36-D3002	36-D7002	36-D0002
220V	36P+G	.47 - .825"	36-C3003-32M	36-C7003	36-C0003-32M
220V	36P+G	.63 - 1.063"	36-C3003	36-C7003	36-C0003

For international configurations (IEC/CE) visit meltric.com/international-catalog or contact customer service at 800.433.7642.

Plug
(male inlet w/handle)



Inlet/Angle (male)



Inlet/Angle/Box (male)



North American UL/CSA Configurations

Voltage	Polarity	Cable Range	Part # Metal	Part # Metal	Part # Metal
440V	24P+G	.47 - .825"	36-D1002-32M	36-D9002	36-D6002-32M
440V	24P+G	.63 - 1.063"	36-D1002	36-D9002	36-D6002
220V	36P+G	.47 - .825"	36-C1003-32M	36-C9003	36-C6003-32M
220V	36P+G	.63 - 1.063"	36-C1003	36-C9003	36-C6003

For international configurations (IEC/CE) visit meltric.com/international-catalog or contact customer service at 800.433.7642.

ACCESSORIES

MULTI-CONTACT REMOVAL TOOL



61-CA593

EUROPEAN CRIMPING TOOL



61-CA500

CRIMPER TOOL (Greenlee or equal)



4CN30

BAG OF 13 FEMALE CONTACTS



61-CA213

Includes insulation sleeves and ferrules

BAG OF 13 MALE CONTACTS



61-CA113

Includes insulation sleeves and ferrules

DXN25C/37C DIMENSIONS – Provided in inches

Dimensions are for reference only and may change depending on accessories used. For precise dimensions contact MELTRIC Engineering.

plug

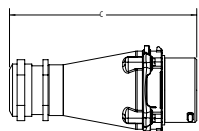
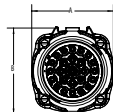

wall box/
angle/
receptacle/
plug

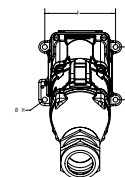
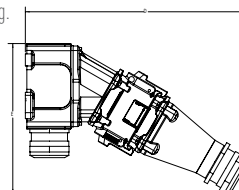

PRODUCT	A	B	C	D	E	F	G	øH
DXN25C/DXN37C	3.17	3.35	7.26	11.64	7.83	3.7	2.76	0.26

SPeX

Hazardous Location
single pole plug and receptacle



Main Advantages

- ▶ Mechanical keying system prevents intermating of phases
- ▶ Reliable mechanical and Electrical interlocking
- ▶ Automatic IP65/IP66 when plug is mated



- ▶ Features & Ratings p. 243
- ▶ SPeX p. 244
- ▶ Dimensions p. 245

PRODUCT FEATURES



Hazardous location rating is based on mandatory use of pilot circuit to make and break load on phase contacts.



Operating Instructions



To connect, insert the plug into the receptacle until a click is heard. Rotation of the plug in either direction engages a locking finger, which prevents further rotation.



To close the pilot circuit and mechanically lock the plug into the receptacle, turn the ring on the receptacle until the "1" lines up with the arrow. This turns the power on.



To disconnect, open the pilot circuit and unlock the plug by turning the ring until the "0" is aligned with the arrow. The power is now off.



Press firmly on the latch release button and simultaneously pull on the inlet. A slight rotation of the plug may also be required.

Hazardous Location Listings (CSA or ATEX)

CSA	ATEX
Class I, Division 2, Group ABCD	⊕ IIC G D Ex e IIC T* Gb Ex IIIC T* Db IP65/IP66
Class II, Division 1 Groups EFG; Class III, Division 1	Suitable for Zone 1 & 2 (gas) 21 & 22 (dust)
Ex e IIC; Ex tb IIIC T56°C or T76°; IP66 (For Canada)	-20°C ≤ Ta ≤ 40°C T5 T56°C
Class I, Zone 1, AEx e IIC T5 or T6	-20°C ≤ Ta ≤ 60°C T5 T76°C
AEx tb IIIC T56°C or T76°C	-20°C ≤ Ta ≤ 40°C T6 T56°C
IP65/IP66 (For US)	-20°C ≤ Ta ≤ +60°C T4 T79°C

Amperage Ratings by Cable Size and ATEX Rating

	-20°C ≤ Ta ≤ 40°C	-20°C ≤ Ta ≤ 40°C	-20°C ≤ Ta ≤ 60°C
	G/D T5/T56°C	G/D T6/T56°C	G/D T5/T76°C
70mm ²	290A	235A	235A
95mm ²	415A	335A	335A
120mm ²	456A	376A	376A
150mm ²	493A	415A	415A
185mm ²	530A	450A	450A
240mm ²	570A	497A	497A
300mm ²	620A	540A	540A
400mm ²	680A	600A	600A

HAZARDOUS LOCATION

SPeX Hazardous Location Plugs & Receptacles

Devices rated for hazardous locations are not returnable.

cCSAus Ratings

- **Voltage**
600 VAC
- **Amperage Ratings**
600A
- **Environmental Ratings**
IP65/IP66
- **Temperature Range**
See table page 225
- **Wiring Capacity**
Min 2/0 AWG Max 750 MCM
Aux Contacts 12-14 AWG
See table page 225
- **Applicable Standards**
CSA C22.2 No. 182.1,
CSA 213-M1987, CSA 25-1966

Plug
(Male inlet w/handle)



Receptacle on angle
(Female)



North American cCSAus Configurations

Color Code	Polarity	Part # without Lug (by cable diameter)				Part # without Lug
		.70 - .98"	.94 - 1.33"	1.33 - 1.65"	1.57 - 1.89"	
	L1	42-41001-32P	42-41001-40P	42-41001-50P	42-41001-63P	42-47001
	L2	42-41002-32P	42-41002-40P	42-41002-50P	42-41002-63P	42-47002
	L3	42-41003-32P	42-41003-40P	42-41003-50P	42-41003-63P	42-47003
	NEUTRAL	42-4100N-32P	42-4100N-40P	42-4100N-50P	42-4100N-63P	42-4700N
	GROUND	42-4100T-32P	42-4100T-40P	42-4100T-50P	42-4100T-63P	42-4700T
	POSITIVE	42-4100P-32P	42-4100P-40P	42-4100P-50P	42-4100P-63P	42-4700P
	NEGATIVE	42-4100M-32P	42-4100M-40P	42-4100M-50P	42-4100M-63P	42-4700M

IEC/CE Ratings

- **Voltage**
1000 VAC
- **Amperage Ratings**
See table page 225
- **Environmental Ratings**
IP65/IP66
- **Temperature Range**
See table page 225
- **Wiring Capacity**
Min 2/0 AWG Max 750 MCM
Aux Contacts 12-14 AWG
See table page 225
- **Applicable Standards**
ATEX, IECEx

Plug
(Male inlet w/handle)



Receptacle on angle
(Female)



IEC/CE Configurations

Color Code	Polarity	Part # without Lug (by cable diameter)				Part # without Lug
		.70 - .98"	.94 - 1.33"	1.33 - 1.65"	1.57 - 1.89"	
	L1	46-41001-32P	46-41001-40P	46-41001-50P	46-41001-63P	46-47001
	L2	46-41002-32P	46-41002-40P	46-41002-50P	46-41002-63P	46-47002
	L3	46-41003-32P	46-41003-40P	46-41003-50P	46-41003-63P	46-47003
	NEUTRAL	46-4100N-32P	46-4100N-40P	46-4100N-50P	46-4100N-63P	46-4700N
	GROUND	46-4100T-32P	46-4100T-40P	46-4100T-50P	46-4100T-63P	46-4700T
	POSITIVE	46-4100P-32P	46-4100P-40P	46-4100P-50P	46-4100P-63P	46-4700P
	NEGATIVE	46-4100M-32P	46-4100M-40P	46-4100M-50P	46-4100M-63P	46-4700M

INSTALLATION ACCESSORIES

Accessories rated for hazardous locations are not returnable.

HANDLES

CRIMPING LUG – Straight w/terminal	Flexible MCM+ Wire Size	Part #
	1	45-4A50C
	2/0	45-4A70C
	3/0	45-4A95C
	250	45-4A12C
	300	45-4A15C
	350	45-4A18C
	450	45-4A24C
	600	45-4A30C
	777	45-4A40C

(Bolt Included)

CRIMPING LUG – Straight Threaded	Flexible MCM+ Wire Size	Part #
	1	45-4A50D
	2/0	45-4A70D
	3/0	45-4A95D
	250	45-4A12D
	300	45-4A15D
	350	45-4A18D
	450	45-4A24D
	600	45-4A30D
	777	45-4A40D

+ Based on flexible type copper cables. See appropriate NEC tables for applicable ampacities.

* Use the straight threaded lug when cord mounting with handle accessory.
** Conductor sizes are approximations based on metric wire size conversions.

Dimensions Inlet/Receptacle – Provided in inches

Dimensions are for reference only and may change depending on accessories used. For precise dimensions contact MELTRIC Engineering.

inlet

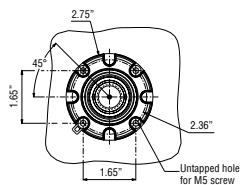

receptacle

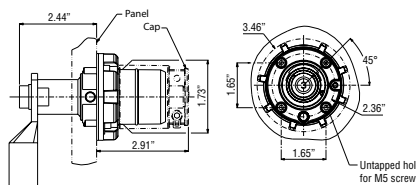

plug

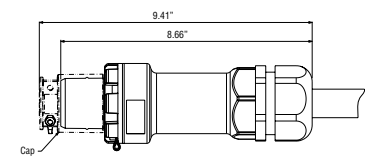

connector

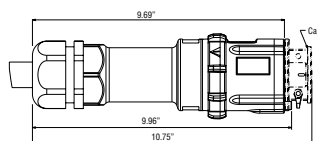

plug/connector

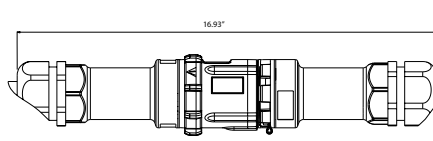

plug with connector on/off

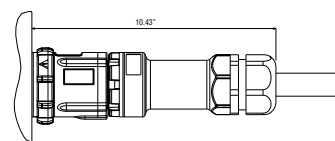

connector with plug on/off

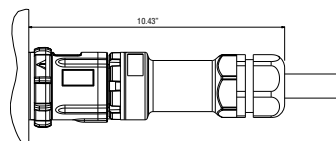

45° inclined receptacle/angle with plug

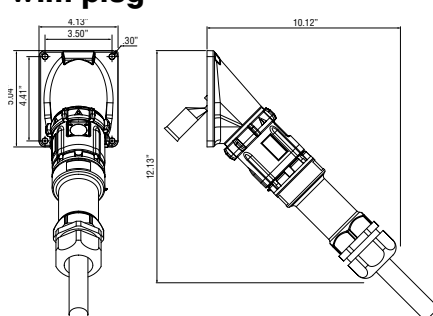

45° inclined inlet/angle with connector

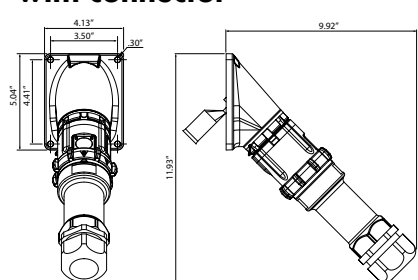

BOXES Hazardous Location



Technor®
A COMPANY OF MARECHAL ELECTRIC

SB Series 316 Stainless Steel Enclosures



- ▶ Meets UL, ATEX and IECEx standards for use in explosive environments
- ▶ Over 20 standard sizes available
- ▶ Custom sizes can be ordered ranging from 100mm x 120mm x 100mm thru 910mm x 1140mm x 500mm
- ▶ Can be ordered empty or as a complete customized control panel per customer specifications

Technical Features

- ▶ **Box material:** Stainless steel AISI 316L, 1.5 mm thickness
- ▶ **Surface treatment:** Acid treatment
- ▶ **Gaskets:** Silicon rubber (suitable for use between -70°C/+200°C)
- ▶ **Environmental Rating:** IP66/IP67, Type 1, 4, 4X, 12
- ▶ **Shock resistance:** IK10
- ▶ **Ambient Temperature:** From -50°C to +60°C (ATEX), From -50°C to +95°C (IECEX)
From -40°C to +40°C (UL)
- ▶ **Approvals:** cULus: file UL E488994
ATEX : IMQ 08 ATEX 028X and IMQ 16 ATEX 004 U
IECEX: IECEX IMQ 15.0002X and IECEX IMQ 15.0010U
EAC: TR CU 05.B.01093
- ▶ **Marking:** Ⓢ II 2 GD
Ex e IIC T(**) Gb / Ex ia IIC T(**) Gb / Ex ib IIC T(**) Gb
Ex tb IIIC T(**) Db IP66/67
** T6/T85°C, T5/T100°C, T4/T135°C
UL Type 1, 4, 4X or 12
- ▶ **Compliance:** IECEX / ATEX: IEC/EN : 60079-0 / 60079-1 / 60079-7 / 60079-11 / 60079-18 / 60079-31
UL : UL 508A and CSA C22.2 No. 14-13
- ▶ **Standard certificate label:** Self adhesive UV and corrosion resistant polyester
- ▶ **Entries:** Up to 90 mm diameter

Key Options Available

- ▶ Entries – added as needed
- ▶ Hinges – optional without
- ▶ Doors – optional locked
- ▶ Side gland plates
- ▶ Other options:
 - ▶ Breather drains
 - ▶ Viewing windows
 - ▶ Ground studs
 - ▶ Internal mounting plates
 - ▶ Acrylic laminated or stainless steel tag & certification labels
 - ▶ Other material thickness available
 - ▶ Electro polishing

SB Series 316 Stainless Steel Enclosure

Devices rated for hazardous locations are not returnable.

PART NUMBER	DIMENSIONS (mm)*					MAXIMUM CABLE ENTRIES W/O GLAND PLATE		MAXIMUM CABLE ENTRIES W/GLAND PLATE		MAX N° TERMINALS		WEIGHT (KG)
	A	B	C	D	E	SIDE A	SIDE B	SIDE A	SIDE B	2,5 MM ²	4 MM ²	
SB-101210**	100	120	100	150	-	4	4	-	-	7	6	1.5
SB-151510**	150	150	100	180	-	6	6	-	-	13	11	2.5
SB-202010	200	200	100	230	160	9	9	-	-	22	19	3
SB-202016	200	200	160	230	160	15	15	8	8	22	19	3.5
SB-204016	200	400	160	230	360	15	30	8	18	66	57	4.8
SB-282816	280	280	160	310	240	21	21	12	12	76	64	5.2
SB-282827	280	280	270	310	240	46	46	33	33	76	64	7.5
SB-302016	300	200	160	330	160	21	15	12	8	44	38	5
SB-383816	380	380	160	410	340	30	30	18	18	114	96	8.1
SB-383827	380	380	270	410	340	67	67	51	51	114	96	10.1
SB-384516	380	450	160	410	410	30	36	18	20	171	144	10.7
SB-385716	380	570	160	410	530	30	45	18	28	228	192	16.4
SB-575716	570	570	160	600	530	45	45	28	28	372	312	16.4
SB-575730	570	570	300	600	530	116	116	95	95	372	312	21.4
SB-577620	570	760	200	600	720	73	98	54	74	558	468	21.7
SB-769520	760	950	200	790	910	98	125	74	94	990	834	32.9
SB-272713	270	270	130	300	230	14	14	6	6	36	30	4.5
SB-353516	350	350	160	380	310	27	27	16	16	102	86	5.6
SB-142013	140	200	130	170	160	6	10	4	4	11	9	4
SB-202713	200	270	130	230	230	10	14	6	6	36	30	7
SB-273513	270	350	130	300	310	14	18	8	8	72	60	9.5
SB-355016	350	500	160	380	460	27	39	16	24	160	134	13
SB-505016	500	500	160	530	460	39	39	24	24	240	201	14.5

* Upon request, any dimension between 100x120x100 and 910x1140x500 can be manufactured.

** The enclosure is only available without hinges.

Dimensions – Provided in mm

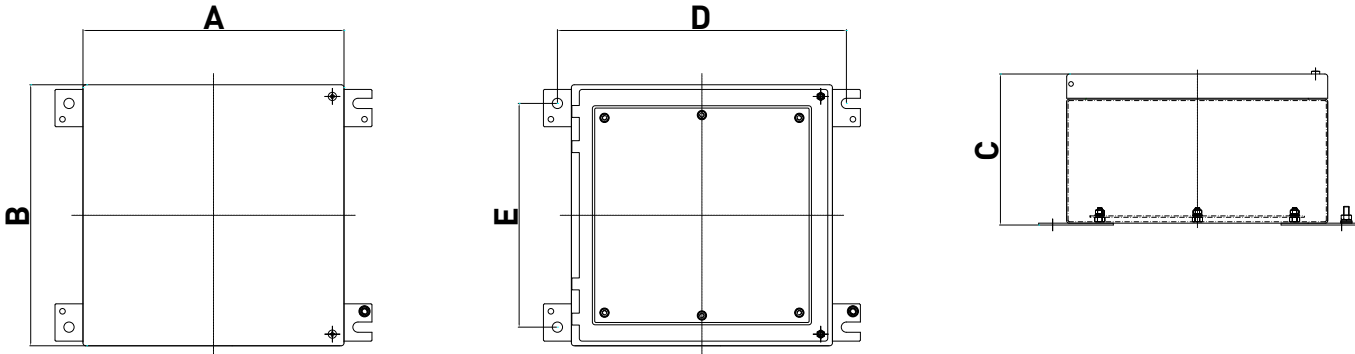

HAZARDOUS LOCATION

ACCESSORIES/OPTIONS



AUXILIARY/PILOT CONTACTS.....	P. 250
ADDITIONAL WATERTIGHTNESS	P. 251
LID CONFIGURATIONS	P. 252
PLUG CAPS.....	P. 253
PAWL OPTIONS.....	P. 254
AUXILIARY SWITCHES.....	P. 255
SELF-EJECTING DEVICES	P. 256

AUXILIARY/PILOT CONTACTS

Auxiliary/pilot contacts can operate secondary circuits on the inlet or receptacle side of the circuit. They make last and break first when the plug is engaged or disengaged from the receptacle. To order a device with auxiliary/pilot contacts, add the appropriate suffix numbers listed to the right. Amperage ratings for the auxiliary/pilot contacts depend on the device size and operating voltage (see table below).



Auxiliary/Pilot Contacts

Switch-rated plugs & receptacles with auxiliary/pilot contacts can make the operation of a facility safer and more efficient by facilitating the use of advanced control schemes. They allow facilities to:

- ▶ **Quickly reconfigure or change-out processing equipment.** – The need for hard-wiring or multiple plug connections is eliminated.
- ▶ **Reduce equipment costs.** – The need for separate connections for the auxiliary/pilot contacts is eliminated.
- ▶ **Simplify the monitoring of key parameters.** – Thermistors on a motor driving a critical process pump can communicate temperature problems via auxiliary/pilot contacts in the Decontactor.
- ▶ **Communicate alarm signals or turn off equipment.** – When a motor is disconnected or unplugged, the auxiliary/pilot contacts can convey a signal that will de-energize the motor starter.

Auxiliary Contact Amperage Ratings

Product	DSN30 DSN60	DSN150	DS20 DS30 (DS60 2 Aux, DS100C 2 Aux)	DS100, DS200	(DS60 3+4 Aux, DS100C 3+4 Aux)	DB30 DB60 DB100	DXN30 DXN60	PFQ300	PF (all sizes)	DR30 DR50 (DR100 2 Aux)	DR150 DR225 DR250 DR400	(DR100 3+4 Aux)	SP	SPeX	DS7c	DR7c
120 VAC	6A	1.5A	6A	1.5A	3A	6A	5A*	7A	10A*	6A	1.5A	3A	0.6A**	-	-	-
240 VAC	3A	0.75A	3A	0.75A	1.5A	3A	5A*	5A	10A*	3A	0.75A	1.5A	0.3A**	6A* (220V max)	-	5A*
480 VAC	1.5A	0.38A	1.5A	0.38A	0.75A	1.5A	5A	2A*	10A*	1.5A	0.38A	0.75A	-	6A* (220V max)	5A* (400V max)	-
600 VAC	1.2A	0.30A	1.2A	0.30A	-	1.2A	5A* (550V max)	2A*	10A*	1.2A	0.30A	0.60A	-	-	5A* (400V max)	-

* Rating is not UL or CSA listed

** Rating is not UL listed.

Ordering Information

To order on a device, add the appropriate suffix to both the inlet and receptacle part numbers.

Product	DSN			DS						DB			DXN		PFQ	PF				DR					DR7c DS7c	SP		
	30	60	150	20	30	60 Poly	60 Metal	100C Poly	100C Metal	100	200	30	60	100	300	300	400	600	30	50	100 Poly	100 Metal	150	250				
2 contacts	-972	-972	-262	-972	-972	-972	-972	-972	-972	-262	-972	-172	-172	-	-972	-972	-	-	-	-	-972	-972	-972	-972	-262	-972	-172	Standard 4
3 contacts	-	-973	-263	-	-973	-263	-263	-263	-263	-263	-	-	-	-	-	-	-	-	-	-	-	-973	-263	-263	-263	-	-173	-
4 contacts	-	-974	-264	-	-974	-264	-264	-264	-264	-264	-174	-	-	-174	-	-	Standard 8	Standard 4	Standard 4	Standard 4	-	-974	-264	-264	-264	-174	-	-
5 contacts	-	-	-975	-	-	-	-	-	-	-975	-	-	-	-	-	-	-	-	-	-	-	-	-	-	-975	-	-	-
6 contacts	-	-	-976	-	-	-	-	-	-	-976	-976	-	-	-	-	-	-	-	-	-	-	-	-	-	-976	-976	-	-

Replacement Auxiliary Contacts

Product	DSN			DS				DR			
	30	60	150	20	30	60	100C	30	50	100	150
Male contact	61-3A011	61-6A011-264	61-9A011-219	31-1A011-30	61-6A011-262	31-6A011-172	31-6A011-172	31-1A011-30	61-6A011-262	31-6A011-172	61-9A011-219
Female contact	61-3A021	61-6A021-264	61-9A229	31-1A021	61-6A021-262	31-6A229	31-6A229	31-1A021	61-6A021-262	31-6A229	61-9A229

ADDITIONAL WATERTIGHTNESS

For additional water protection when the inlet and receptacle are mated the following Type 4X option may be ordered for DS or DR models.

Type 4X Watertightness

Type 4X waterproofing is used for applications where connectors, plugs, and receptacles are subjected to water pressure. A gasket is added to the inlet and the receptacle lid is made to normally close.

Example:

To order on a device add suffix -4X to the inlet and receptacle part number.

DS20 Poly Inlet 2P + E = 33-18162-4X



To Order Gaskets Separately

Model	DS								DR					
	20	30	60 Poly	60 Metal	100C Poly	100C Metal	100 Metal	200	30	50	100 Poly	100 Metal	150 Metal	250
Type 4X	31-1A056	31-3A056	31-6A066	39-6A066	31-6A066	39-6A066	31-9A066	39-2A056	31-1A056	31-3A056	31-6A066	39-6A066	31-9A066	39-2A056

LID CONFIGURATIONS

There are four standard open lid configurations depending on the model and size of the device: 180° open, 120° open, 90° open and detached. Optionally, customers can order lids that are normally closed, or if the lid opens to 120° as standard, it can be ordered to open 180° for flush mounted inlets (DS & DR only).

Standard Lid Configurations



180° OPENING LIDS

Standard for:

DSN20, DSN30, DSN60, DSN 150 poly
DS20, DS30, DS60 Poly, DS100C poly, DS100 poly
DR30, DR50, DR100 poly, DR150 poly
DSDC1, DSDC3, DSDC6 poly, DSDC9 poly

120° OPENING LIDS

Standard for:

DX20, DX30, DX60, DX100
DXN20, DXN30, DXN60

90° OPENING LIDS

Standard for:

DSN150 metal
DS60 metal, DS100c metal, DS100 metal, DS200
DR100 metal, DR150 metal, DR250, DR400
DSDC6 metal, DSDC9 metal, DSDC2 metal
DS60, DSN150 Hazardous Rated

DETACHED LIDS

Standard for:

DB30, DB60, DB100
PFQ300, PF300, PF400, PF600
SP
DXA1
DXN25c, DXN37c

Optional Lid Configurations

Closed Lid

Designed for female devices only. A normally closed lid configuration is available for applications where it is desirable to protect the receptacle face from dust, debris, or potential damage. This option provides a lid that will automatically close to a pre-latch position after removal of the plug. The lid must still be latched manually in order to achieve rated watertightness.

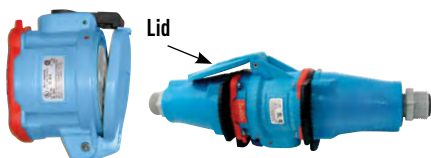

Normally closed lid configuration is recommended for cord to cord applications to keep the lid tucked in and avoid damage.

CLOSED LID

Available as option on:

DSN (All sizes)
DS100 (All sizes)
DR (All sizes)
DN (All sizes, except DN7c)

Examples:

To order a DSN, DS, DR, or DN device with a closed lid add **-NC** to the receptacle part number.

DS20 Poly receptacle 2P+G = 33-14162-NC

To order a DXN device with a closed lid add **-R** to the receptacle part number.

DXN receptacle 2P+G = 22-14162-R

180° Open Lid for Flush Mounted Inlets (DS, DR & DXN devices only)

When ordering an inlet that will be mounted directly flush against a wall or surface without an angle or box, the connector (receptacle + handle) may require the lid to be set for 180° opening.



180° OPEN LID FOR FLUSH MOUNTED INLETS

Available as option on:

DSN150 metal
DS60 metal, DS100c metal, DS100 metal, DS200
DR200 metal, DR150 metal, DR250
DXN20, DXN30, DXN60

Example:

To order this configuration add suffix **-180** to the receptacle part number.

DS100 Metal Receptacle 3P+N+G = 37-94047-180

PLUG CAPS

Protective Neoprene Plug Caps

Neoprene caps provide an extra level of protection from dust, dirt, and rough handling for male plugs.

Watertight

Non-Watertight*



Typical for DSN, DS20, DS30, DS60, DS100C, DR30, DR50, DR100, DXN

Typical for DS100, DS200, DR150, DR250

Typical for DB and DN devices

Typical for PN devices

Padlockable Plug Caps

Padlockable caps can be locked in place to prevent unwanted removal.



Typical for: DSN20, DSN30, DSN60, DS20, DS30, DS60, DS100C, DR30, DR50, DSDC1, DSDC3, DSDC6

Typical for: DS60, DS100C, DS100, DS200, DSN150, DR100, DR150, DR250, DSDC9, DSDC2

Ordering Information

Model	Neoprene Plug Cap
DSN20	61-1A426
DSN30	61-3A426
DSN60	61-6A426
DSN150	35-9A426
DS20	31-1A426
DS30	31-3A426
DS60	31-6A426
DS100C	31-6A426
DS100	35-9A126
DS200	35-2A126
DB30	873A126
DB60	876A126
DB100	879A126
DXN20	221A426
DXN30	223A426
DXN60	226A426
DR30	31-1A426
DR50	31-3A426
DR100	31-6A426
DR150	35-9A126
DR250	35-2A126
DN9c	191A126
DN20c	196A126
PN20	01-2A126

Ordering Information

Model	Padlockable Plug Cap
DSN20	61-1A826*
DSN30	61-3A826*
DSN60	61-6A826*
DSN150	DS9MC (Alum)
DS20	DS1PC (poly)/DSDC1
DS30	DS3PC (poly)/DSDC3
DS60	DS6MC (Alum)/DS6PC (Poly)/DSDC6 (Poly)
DS100C	DS6MC (Alum)/DS6PC (Poly)
DS100	DS9MC (Alum)/DSDC9
DS200	DS2MC (Alum)/DSDC2
DR30	DS1PC (poly)
DR50	DS3PC (poly)
DR100	DS6MC (Alum)/DS6PC (Poly)
DR150	DS9MC (Alum)
DR250	DS2MC (Alum)
DR400	DS2MC (Alum)

* Maintains IP66/IP67 and Type 4X protection

Notes: A 5/16" diameter lock/pin is needed for proper operation. Do not substitute a smaller diameter lock/pin.



*The lockout hole is not completely sealed off by the neoprene caps or the DS_PC and DS_MC caps. If environmental protection is needed while the plug is disconnected, the inlet should be ordered without the standard hole.

Example:

To order an inlet without a lockout hole add suffix -A155 to the inlet part number.

DS20 Poly inlet 2P+G= 33-18162-A155

PAWL OPTIONS

Mushroom Pawl

The mushroom pawl is available as an alternative to the standard pawl. It is ideal for a quick disconnection of motors and other equipment, or in areas where employees use gloves and it is difficult to operate the standard pawls. The button has a red "stop" label for easy recognition.

Example:

To order on a receptacle add suffix **-375** to the receptacle part number.

DSN20 poly receptacle 2P+G=63-14162-**375**



Available on:

DSN, DS, DR and DN devices only

Locking Mushroom Pawl

Locking mushroom pawls are available that include a screw which can be tightened to "lock" the pawl in place thus preventing release of the plug or the lid.

Example:

To order on a receptacle add suffix **-845** to the receptacle part number.

DS30 poly receptacle 3P+G=33-34163-**845**



Available on:

DSN, DS, DR and DN devices only

Padlockable Mushroom Pawl

A padlockable mushroom pawl can be provided with a .32" hole that enables the lid to be locked closed, prohibiting access to the receptacle. Lockout Pin sold separately.

Example:

To order on a receptacle add **-375-843** to the receptacle part number.

To order a lockout pin order part **LP-843**.

DS30 poly receptacle 3P+G=33-38043-**375-843**



Optional pin sold separately.

Available on:

DSN, DS, DR and DN devices only

Notes: A 5/16" diameter lock or lockout pin is needed for proper operation. Do not substitute a smaller diameter lock/pin.

Padlockable Standard Pawl

Standard pawls can be provided with a .32" hole that allows the lid of the receptacle to be locked closed or alternatively the plug can be locked in the connected position. Lockout Pin sold separately.

Example:

To order on a receptacle add suffix **-843** to the receptacle part number.

To order a lockout pin order part **LP-843**.

DSN20 poly receptacle 2P+G=63-14162-**843**



Optional pin sold separately.

Available on:

DSN, DS, DR and DN devices only

Notes: A 5/16" diameter lock or lockout pin is needed for proper operation. Do not substitute a smaller diameter lock/pin.

Metal Pawl

Metal pawls are standard with metal receptacles only. If you prefer a metal pawl on a poly receptacle, add suffix **-824** to the poly receptacle part number.

Example:

DS60 poly receptacle 3P+G=33-64163-**824**



Available on:

DSN, DS, DR and DN devices only

AUXILIARY SWITCHES

Female receptacles/connectors with up to 3 poles/4 wires are available with an optional auxiliary switch for operating secondary circuits on the line side of the circuit. The auxiliary switch is rated at 5A and includes one set of NO and one set of NC contacts. With the three phase devices the neutral contact of the plug operates the switch which is located in the neutral contact position in the receptacle. With the single phase units the third phase contact on the plug operates the switch which is located in the third phase contact position in the receptacle.

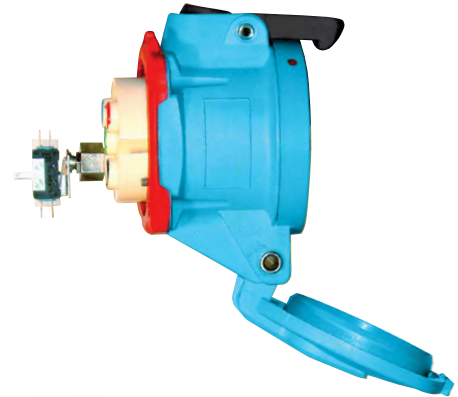

Examples:

Order a receptacle with an auxiliary switch by adding suffix **-270** to the receptacle part number.
DSN30 Poly Receptacle 3P+G = 63-34043-**270**

If the receptacle is 3 pole/4 wire, the mating plug must be ordered as a 4 pole/5 plus the suffix **-NNF** should be added.
DSN30 Poly Inlet 3P+N+G = 63-38047-**NNF**

If the receptacle is 2 pole/4 wire (with neutral) the mating plug must be ordered as a 4 pole/5 wire and the suffix **-3NF** must be added.
*DSN30 Poly Inlet 2P+N+G = 63-38076-**3NF**

Notes: Devices ordered with auxiliary switch option are not UL/CSA listed.

SELF-EJECTING DEVICES

General

Self-ejecting devices protect equipment from damage caused when mobile equipment is accidentally moved without disconnecting power. Self-ejecting systems are designed to automatically release the plug or connector when tension is detected by a tension cord attached between the pawl and the power cable.

Applications

Self-ejecting devices are commonly used on truck hook-ups, cranes, railroad cars, refrigerated food carts, delivery vehicles and other portable equipment.

Self-Ejecting Female Connector/Receptacle

For self-ejecting female connectors, the standard pawl on the connector is replaced by a "shark's fin" pawl that is attached to the power cable via a tension cord. If the connected equipment is moved, the tension cord lifts the shark's fin pawl and the connector is released before damage can occur.

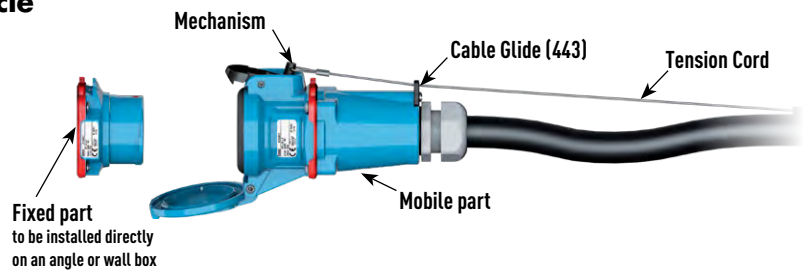

Available on:

DSN (All sizes)

DS (All sizes, except DS200)

DN9c*, DN20c*

How To Order:

To the female receptacle, add suffix **-354**
To the handle part number, add suffix **443**

Example:

To order a DSN30 self-ejecting receptacle and poly handle (3/4" NPT), the part numbers would be:

Receptacle: 63-34043-354

Handle: 512PON07443

* For DN9c and DN20c ordering, use suffixes listed in DN9c and DN20c section

Notes: Self-ejecting devices are modified to allow straight insertion. This defeats the safety shutter and voids the device's switch-rating.

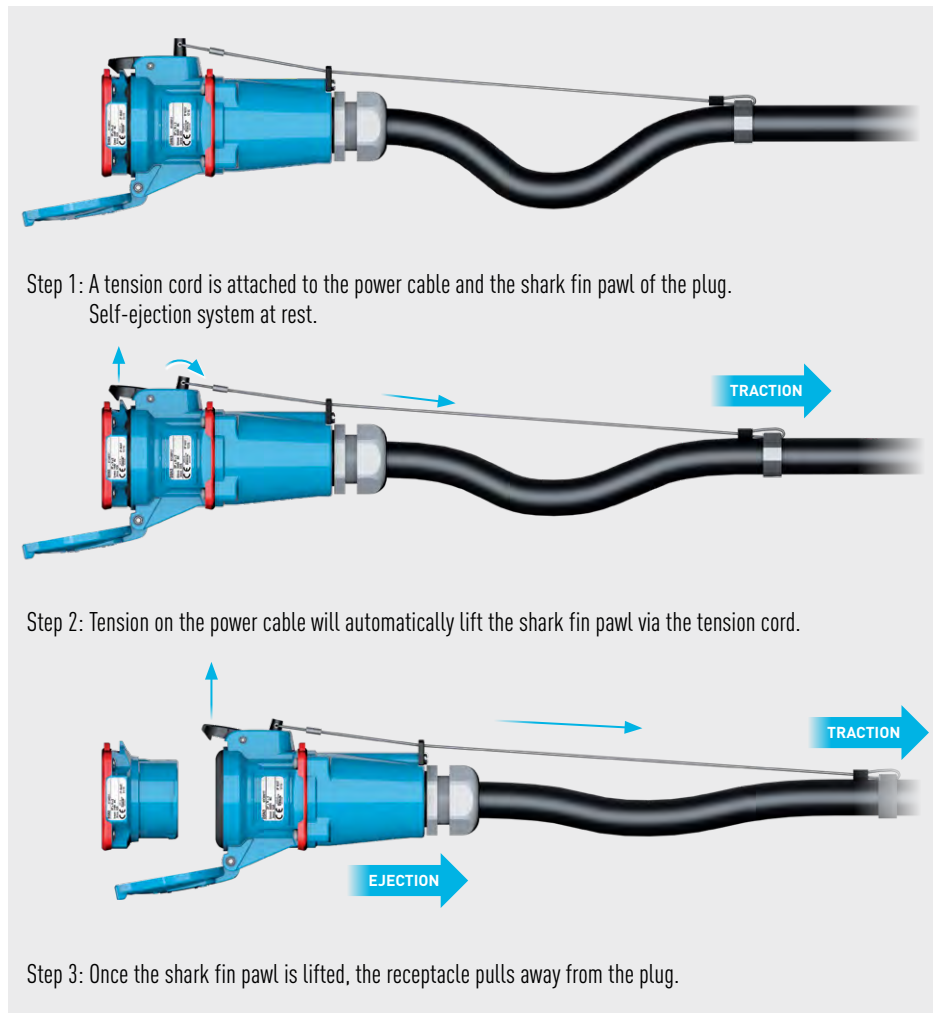

Self-Ejecting Plug

For self-ejecting plugs, a shark's fin mechanism is added to the assembly and attached to the power cable via a tension cord. When tension is applied to the power cable, the tension cord lifts the shark fin mechanism, which in turn lifts the standard pawl on the receptacle and releases the plug before damage can occur.

Available on:

DSN20, DSN30, DSN60

DS20, DS30, DS60, DS100C

DSN24c, DSN37c, DS7, DR7

How To Order:

To the male inlet, add suffix **-338**

To the female receptacle, add suffix **-352**

To the handle part number, add suffix **443**

Example:

To order a DSN30 self-ejecting plug, receptacle and poly handle (3/4" NPT), the part numbers would be:

Inlet: 63-38043-338

Receptacle (straight Insertion): 63-34043-352

Handle: 512PON07443

Notes: Self-ejecting devices are modified to allow straight insertion. This defeats the safety shutter and voids the device's switch-rating.

* A new shark's fin mechanism with similar functionality will be implemented in 2018. Contact Customer Service or visit meltric.com for updates.

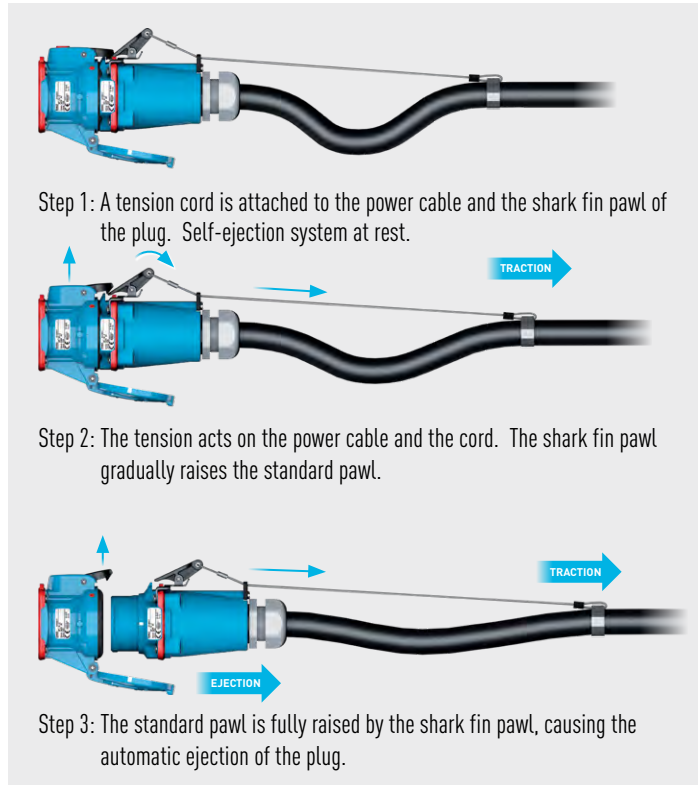
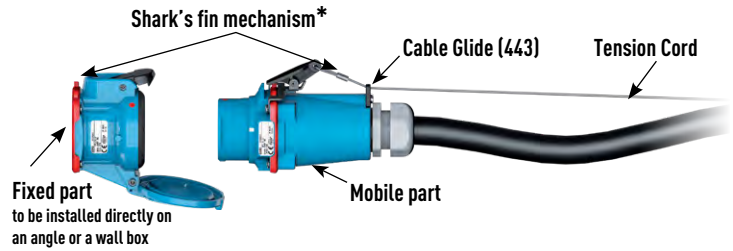

Self-Ejecting Plug (DS100, DSN150, DS200, DN20c only)

For self-ejecting plugs on DS100, DSN150, DS200 and DN20c models, a cam mechanism is used in lieu of the 'shark-fin mechanism'. The principle of operation remains the same.

How To Order:*

To the male inlet, add suffix **-338**

To the female receptacle, add suffix **-352**

To the handle part number, add suffix **443**

Example:

To order a poly DS100 self-ejecting plug, receptacle and poly handle (3/4" NPT), the part numbers would be:

Inlet: 33-98043-338

Receptacle (straight Insertion): 33-94043-352

Handle: 515PON07443

* For DS200 ordering, use suffixes listed in DS200 section

* For DN20c ordering, use suffixes listed in DN20c section

Notes: Self-ejecting devices are modified to allow straight insertion. This defeats the safety shutter and voids the device's switch-rating.



Available on:

DSN150

DS100, DS200

DN20c

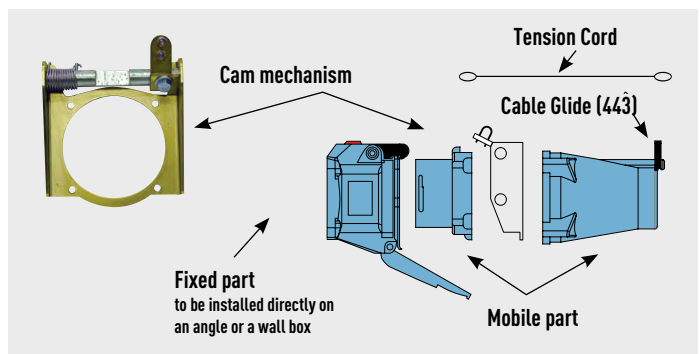

TECHNICAL MANUAL & REFERENCE



SWITCH-RATINGS VS CURRENT INTERRUPTING RATINGS..	P. 260
ELECTRICAL PERFORMANCE	P. 261
BUTT-CONTACT TECHNOLOGY	P. 262
DEAD-FRONT CONSTRUCTION	P. 266
KEYING SYSTEM	P. 267
DUAL VOLTAGE DEVICES	P. 267
RESISTANCE TO ENVIRONMENTS AND CHEMICALS	P. 268
WATERTIGHTNESS/INGRESS PROTECTION	P. 270
IMPACT RESISTANCE	P. 271
OPERATING TEMPERATURES	P. 271
COLOR-CODED GASKETS & LABELS	P. 272
SUFFIXES	P. 274
ACCESSORY PART NUMBER CROSS REFERENCE	P. 276
PARTS INDEX	P. 278

ELECTRICAL PERFORMANCE – Switch-Rated, Current Interrupting Rated and Non-Current Interrupting Rated Devices

Switch-Rated Plugs & Receptacles

MELTRIC’s DSN, DS & DB Series products are UL & CSA listed as switch-rated plugs and receptacles. These ratings allow them to be used as a motor circuit disconnect switch, as well as a branch circuit disconnect switch. Switch-rated plugs and receptacles have passed electrical overload, short circuit and endurance tests that are far more rigorous than those applied to other plugs and receptacles. These tests include the functional requirements for safety disconnect switches in addition to manual motor controllers. For more information about the tested electrical performance of switch-rated devices consult pages 242 - 245.

Current Interrupting Rated Plugs & Receptacles

Other MELTRIC devices such as the DXN plugs and receptacles are UL and/or CSA rated for “current interrupting”. A current interrupting rated plug and receptacle is not subjected to the same level of endurance testing as a switch-rated device and does not need to be subjected to any overload-locked rotor or short circuit testing (see pages 242 - 245 for performance test comparisons). Plug and receptacles rated for “current interrupting” are not intended to be used as switches, but can withstand making and breaking of normal resistive loads. Devices that are not hp and short circuit rated are not intended to make and break motor loads or other inductive loads.

Non-Current Interrupting Rated Plugs & Receptacles

Many competitive plugs and receptacles, as well as some MELTRIC devices are “non-current interrupting” rated. They are not approved by UL or CSA for connecting or disconnecting under load. They have passed the minimum test requirements for plugs and receptacles but they have not passed current interrupting performance tests or the more demanding electrical endurance, overload and short circuit tests required of switch-rated devices. For more information about the tested electrical performance of non-current interrupting rated devices consult pages 242 - 245.

Ratings	Product
Switch-Rated	DSN
	DS
	DB
Current-Interrupting Rated	DXN
	DXA1
	Multipin
	DR
	PN
	DX
	Competitors Pin and Sleeve
Non-Current Interrupting Rated	Multipin
	PF/PFQ
	DSDC
	SPeX
	DS60, DSN150 (Haz Loc)
	Competitors Pin and Sleeve

ELECTRICAL PERFORMANCE

Overload Conditions

UL & CSA standards for plugs and receptacles require that the devices be able to withstand overload conditions. General use conditions are simulated by testing a device to a specified number of operations (50) at 150% of rated current and a power factor between 0.75 and 0.80. Switch-rated plugs and receptacles that are horsepower rated must perform overload testing at 600% of full load motor current with a more severe power factor (between 0.40 and 0.50) to simulate locked rotor conditions.

UL & CSA Standards – Overload Test Requirements and Ratings Comparisons

Test	UL 1682 & CSA 22.2 No. 182.1		UL Subject 2682 (used for both UL & CSA listings)
	Plugs, Receptacles & Cable Connectors of the Pin & Sleeve Type		Switch-Rated Plugs & Receptacles
	Non-Current Interrupting (Typical)	Current Interrupting (Typical)	Motor/Branch Circuit Switch-Rated (Typical)
Overload (General Use Devices)	3 Operations @ 150% of Rated Current (p.f. = .75 - .80)	50 Operations @ 150% of Rated Current (p.f. = .75 - .80)	50 Operations @ 150% of Rated Current (p.f. = .75 - .80)
Overload - Locked Rotor (Horsepower Rated Devices)	-	50 Operations @ 600% Full Load Motor Current (p.f. = .40 - .50)	50 Operations @ 600% Full Load Motor Current (p.f. = .40 - .50)

The overload requirement for testing DC devices is 1 operation.

Test Results: Completed Operations at Overload/Locked Rotor Condition

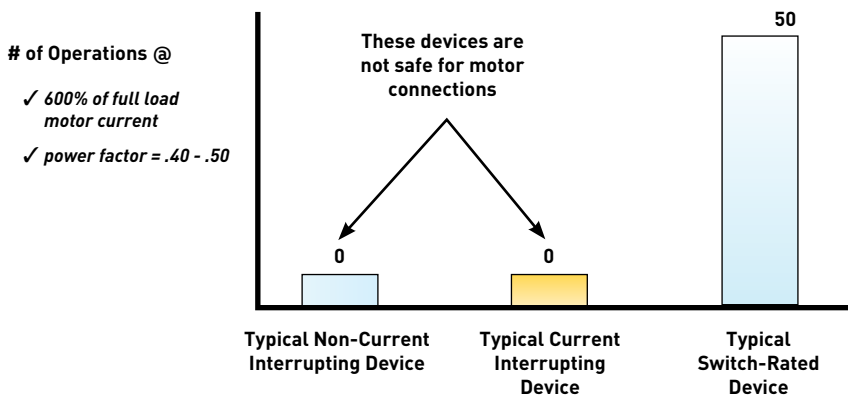

i MELTRIC devices can withstand temporary overloads due to frequent restarting of motors. The same cannot be said for brass pin and sleeve devices. Temporary overloads may heavily oxidize the contacts and cause them to weld.



Motors and other equipment can be quickly and safely connected or disconnected with MELTRIC's Switch-Rated plugs and receptacles.

ELECTRICAL PERFORMANCE

Mechanical and Electrical Endurance

UL and CSA standards require endurance testing to ensure that rated performance is maintained over the expected life of the device. The severity of this testing depends on the rating of the device.

As shown in the chart below, non-current interrupting devices are tested only for mechanical endurance. Current interrupting devices are additionally subjected to moderate electrical endurance testing, and switch-rated devices are subjected to a much more severe level of electrical endurance testing, which is similar to that required of disconnect switches. In this regard, switch-rated devices may be required to make and break under full load more than 20 times as many operations (depending upon device amperage) as a current interrupting rated pin and sleeve device.

UL & CSA Standards – Overload Test Requirements and Ratings Comparisons

Test	UL 1682 & CSA 22.2 No. 182.1		UL Subject 2682 (used for both UL & CSA listings)
	Plugs, Receptacles & Cable Connectors of the Pin & Sleeve Type		Switch-Rated Plugs & Receptacles
	Non-Current Interrupting (Typical)	Current Interrupting (Typical)	Motor/Branch Circuit Switch-Rated (Typical)
Mechanical Endurance (no load)	15-20A = 5000 Operations 21-63A = 2000 Operations 64-250A = 250 Operations	15-20A = 0 Operations 21-63A = 1000 Operations 64-250A = 500 Operations	4000 Operations
Electrical Endurance (with load)	-	15-20A = 5000 Operations 21-63A = 1000 Operations ¹ 64-250A = 250 Operations ¹ @ Rated Current & Voltage (p.f. = .75 - .80)	6000 Operations @ Rated Current & Voltage (p.f. = .75 - .80)

Notes: ¹ Testing alternates between mechanical & electrical operations. This reduces the severity of the electrical test by allowing additional cooling time during electrical testing.

Electrical Endurance Test Comparison

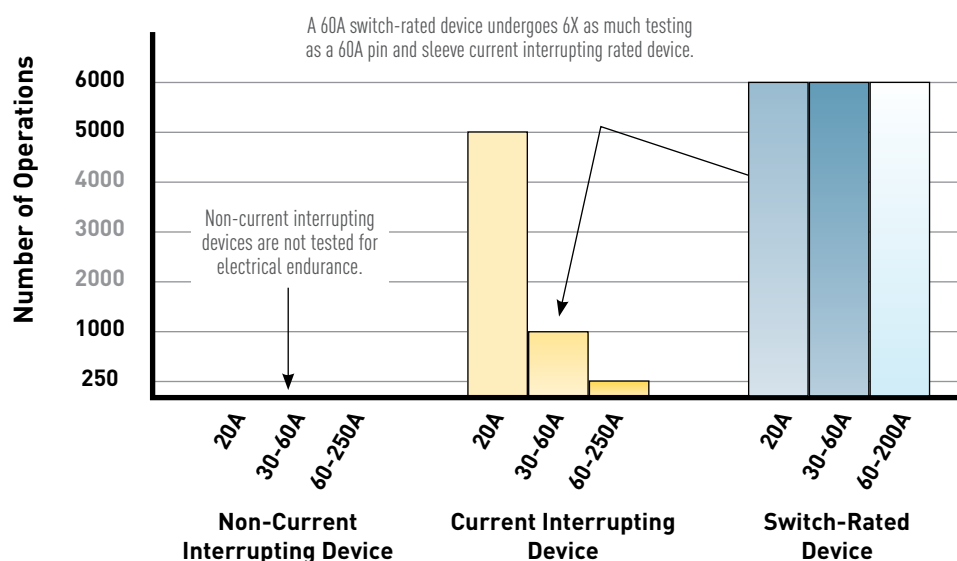

ELECTRICAL PERFORMANCE

Short Circuit Protection

MELTRIC's DS, DSN, and DB products have successfully completed high fault current short circuit testing. All these devices have short circuit make (close) and withstand ratings of either 65 kA or 100 kA (10 kA for DS200)**. UL witnessed and approved this testing.

UL Recognized Short Circuit Capabilities

Plug & Receptacle Type	UL Recognized Short Circuit Capabilities		Product Standard
	Short Circuit Ratings		
	Withstand	Make	
General Use Pin & Sleeve Devices	None	None	UL 1682
HP Rated Twist-Type Devices	1kA	None	UL 498
Motor Rated Pin & Sleeve Devices	10kA	None	UL 1682
MELTRIC Switch-Rated Devices	≥ 65kA**	≥ 65kA**	UL Subject 2682

Short Circuit Test Information

Fusing – The amperage and time delay characteristics of the fusing used in testing affects the electrical load seen by the device. UL Subject 2682 requires short circuit tests be performed with fuses having an amperage rating that is no less than 400% of full load motor ampacity for horsepower rated devices, or no less than 100% of the device's amperage rating for general use devices.

MELTRIC used RK1 non-time delay type fusing for the horsepower rated devices because it is a common type of fuse used in motor applications.

Power Factor – The lower the power factor (p.f.) the more rigorous the test. UL Subject 2682 requires short circuit testing at 42,000 amps and above to be performed with a p.f. of 0.15 or less. By comparison, the p.f. for the 10,000 amp short circuit withstand test required by UL 1682 for horsepower rated plugs & receptacles, is a much less rigorous 0.50.

Short Circuit Test Summary Table

Model	Device Information		Short Circuit Make & Withstand Rating ¹			
	General Use Rating	Max Motor FLA	kA	VAC	Fusing used in Testing	
DSN20	20A	8A (2 hp @ 208 VAC)	100	600	RK1	35A
DSN30	30A	17A (15 hp @ 600 VAC)	100	600	RK1	125A
DSN60	60A	27A (20 hp @ 480 VAC)	100	600	RK1	125A
DSN150	150A	96A (75 hp @ 480 VAC)	10	600	RK1	400A
	-	-	100	600	RK1	225A
DS20	20A	17A (5 hp @ 208 VAC)	100	600	RK1	80A
DS30	30A	21A (15 hp @ 480 VAC)	100	600	RK1	125A
DS60	60A	27A (25 hp @ 600 VAC)	100	600	RK1	250A
DS100C	100A	65A (50 hp @ 480 VAC)	100	600	RK1	250A
DS100	100A	40A (30 hp @ 480 VAC)	65	600	RK1	175A
	100A	-	65	600	RK5 TD	100A
DS200	200A	124A (100 hp @ 480 VAC)	10	600	RK1	500A
DB30	30A	27A (25 hp @ 600 VAC)	100	600	RK1	125A
DB60	60A	49A (15 hp @ 208 VAC)	100	600	RK1	250A
DB100	100A	92A (30 hp @ 208 VAC)	100	600	RK1	250A

¹ Testing was performed with RK1 current limiting fuses sized at 400% of the highest full load motor ampacity associated with the device's hp rating. DS100 & 200 are rated 65kA.

* The fusing used limits the 100kA rating to 60hp @ 600V, 40hp @ 480V, 20hp @ 240V & 208V.

CONTACT TECHNOLOGY

Silver-Nickel Contact Material

MELTRIC products feature solid silver-nickel (85%/15%), spring-loaded butt contacts similar to those used in motor starters and contactors. The silver-nickel material has significant advantages over the brass contacts commonly used on competitive devices.

Silver has very low initial contact resistance and is not negatively affected by oxidation. This helps to give it excellent electrical properties that are maintained even at high temperatures and after tarnishing. Nickel is a much harder material and contributes excellent mechanical properties. The combination of silver and nickel results in a contact material that has both superior electrical capabilities and excellent resistance to wear. Silver-nickel only welds at extremely high pressure and temperature, and thus, also withstands arcs very well. These features make silver-nickel a commonly used contact material by switchgear manufacturers.

By contrast, the brass material used in most competitive plugs and receptacles has much higher initial contact resistance and is negatively affected by oxidation. In an oxidized state, the contact resistance of brass is more than 20 times higher than that of silver-nickel. In addition, brass is a soft material that wears rapidly. In use, brass pin and sleeve and arcuate contacts suffer from the combined effects of the limitations of the material and the design. As oxidation and wear induced reductions in contact force occur, contact resistance increases. This increases operating temperature, which causes further oxidation and wear, perpetuating a vicious cycle of degradation. Brass is not arc resistant and is not suitable for making and breaking under load.

Spring-Loaded Contacts

Spring-loading of the contacts ensures that optimal pressure between the contacts is maintained – even after tens of thousands of operations. This point is important because contact force is a key determinant of the quality of the connection. As the accompanying graph demonstrates, contact resistance increases as contact force decreases. Higher contact resistance generates more heat and oxidation, both of which contribute to the deterioration of the contact. This is a problem with pin and sleeve and arcuate type contacts because their contact force varies with manufacturing tolerances and is reduced due to wear that occurs with normal use.

Butt-Style Connection

MELTRIC's butt-style contact configuration provides a positive and secure connection and also makes connection and disconnection easy. With butt contacts, the force applied to the contacts is in-line with the insertion motion, so inserting a plug into its socket requires only a known and limited amount of effort. Contact wear and sensitivity to manufacturing tolerances is negligible, because the spring-loading is sufficient to compensate for minor differences in contact length.



MATERIAL	CONTACT	RESISTANCE
	NEW	OXIDIZED
SILVER	6 $\mu\Omega$	25 $\mu\Omega$
SILVER-NICKEL	23 $\mu\Omega$	60 $\mu\Omega$
COPPER	29 $\mu\Omega$	400 $\mu\Omega$
BRASS	370 $\mu\Omega$	1400 $\mu\Omega$

In an oxidized state, silver-nickel is 20 times more conductive than brass.

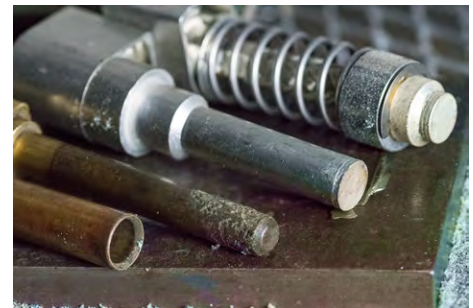

Comparison of pin and sleeve to MELTRIC solid silver-nickel contacts

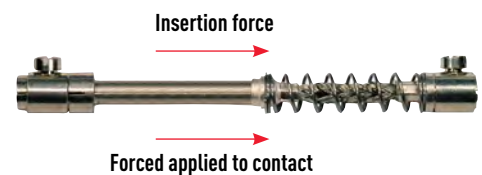
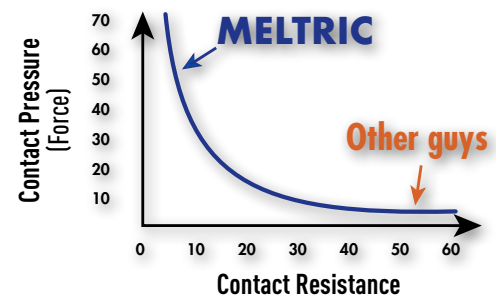

With MELTRIC's butt contacts the force applied to the contacts is in-line with the insertion motion.

With the pin and sleeve design used by our competitors, the contact force is at a right angle to the insertion/withdrawal force. There are numerous drawbacks to such a design:

- ▶ The contact pressure must be sufficient to prevent excessive temperature rise but is limited by the need to keep the insertion force reasonable.
- ▶ The necessary friction wears out the contacts, and diminishes contact pressure over time.
- ▶ Normal manufacturing tolerances result in wide variations in performance, even with new devices.
- ▶ The sliding contact design does not make & break cleanly, so arcing is more likely to occur.

Quick Break Mechanism

On most MELTRIC devices, the circuit is broken simply by depressing the pawl. Doing so releases the energy in a spring-loaded operating mechanism, which instantaneously breaks the circuit and ejects the plug to the 'OFF' position. Contact breaking time is about 15 milliseconds. The quick break mechanism is automatically reloaded when the plug is re-inserted.

In contrast, the disconnection speed of pin and sleeve and twist type devices is dependent on the users motion when removing the plug.

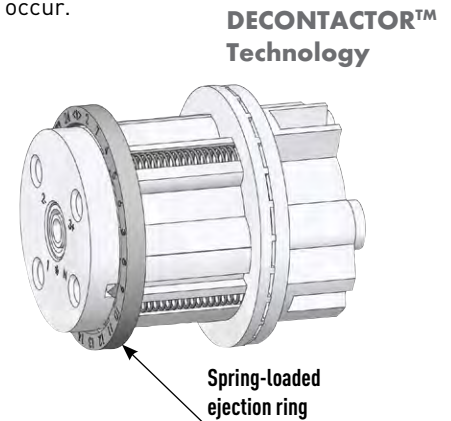

Spring-loaded ejection system ensures a quick break of the contacts.

Self-Cleaning System

Most MELTRIC contacts close with a self-cleaning, wiping action. When the contacts initially mate, they are slightly offset. In completing the connection, the plug contacts are rotated partially across the receptacle contacts, helping to remove deposits from the contact surface.

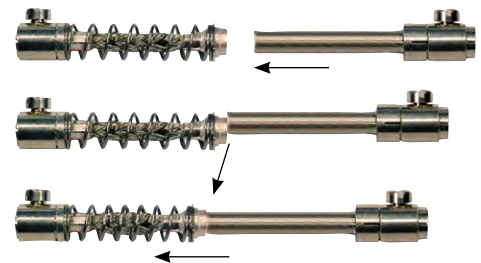

MELTRIC contacts are self cleaning.

Contact Mating Sequence

MELTRIC contacts mate in a specific sequence to ensure a proper and safe connection.

1. The earth (ground) closes first
2. Then the neutral,
3. Then the phases,
4. Then the auxiliary contacts, if any. These auxiliary contacts can, therefore, be used as "pilot" contacts.

On opening, the sequence is reversed.

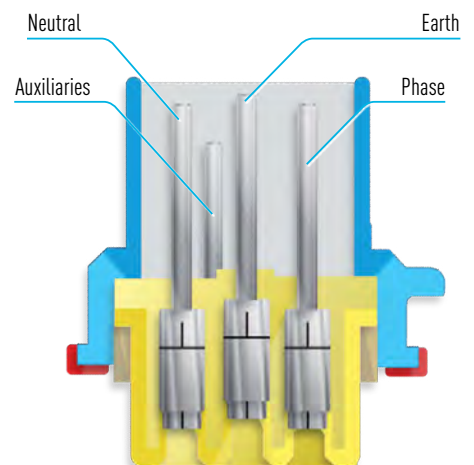

The contacts are set in the plug at different levels to achieve the desired mating sequence.



This design ensures no arc at connection and disconnection.

DEAD FRONT AND ENCLOSED ARC CHAMBERS

For Maximum Protection from Live Parts

Most MELTRIC receptacles feature a dead front which encloses and isolates the live contacts when the plug is removed. Only electrically compatible plugs can unlock the safety shutter and gain access to the live parts. In addition to preventing accidental exposure to live parts, the safety shutter also keeps the contacts clean and out of reach even if the lid is left open.



The receptacle's dead front protects workers from accidental tool and wire insertion.

Protection During the Making and Breaking Process

When disconnecting or connecting a MELTRIC plug from/to a receptacle, the user is completely protected from exposure to arc flash or live parts. This is because the contacts can only make or break while they are enclosed in internal arc chambers within the receptacle.

During disconnection, the pressing of the pawl on the receptacle breaks the connection (inside the arc chambers) and ejects the plug to its rest or "OFF" position. While in the rest position, the plug and receptacle casings maintain a dead front and thus protect the user from live parts. The plug can not be fully withdrawn until it is rotated 30° counterclockwise. This closes and locks the safety shutter preventing access to live parts during and after the removal of the plug.

During connection, the plug contacts can only access the receptacle contacts after the plug has been partially inserted into the receptacle and has then been rotated 30° to open the safety shutter. Because the interaction of the skirted plug casing with the receptacle forms a protective enclosure that prevents access to the contacts as soon as insertion begins, a dead front is maintained even after the safety shutter is opened. Once the safety shutter has been opened, can the plug contacts be safely inserted into the arc chambers where the connection is made as the plug is latched to the receptacle.

DECONTACTOR™ Technology

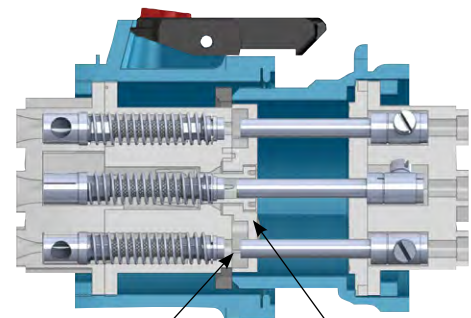

Arc chamber prevents outside exposure to arc flash.

Safety shutter prevents finger or tool access to live parts.

Protection from Insertion of Inappropriate Plugs

MELTRIC products offer up to 24 different keying positions. Only plugs and receptacles that are keyed/notched in the same positions will mate with each other. Non-compatible plugs will be unable to open the safety shutter. This system prevents potentially dangerous situations. For example, a 250VAC plug (notch 07) can not be inserted into a 480VAC receptacle (notch 04). Alternatively, on the PF and DX series, pegs and holes perform the same function as the notches.

Note: Some of the keying positions have been assigned to a designated global voltage. A few others are unassigned and are available if a user prefers to limit mating of plugs and receptacles that are only to be used on particular applications.

Commonly Used Keying Positions

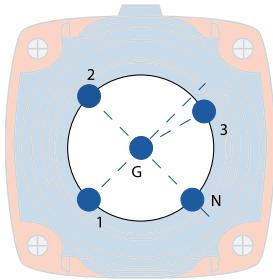

Position 04
255-277VAC/440-480VAC 60Hz

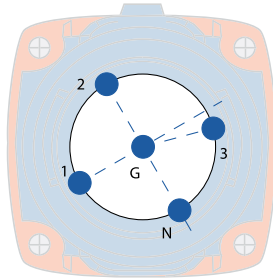

Position 07
110-125/220-250VAC 60Hz

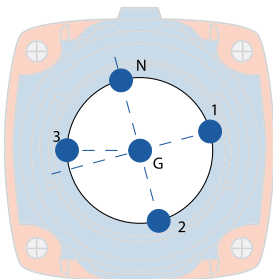

Position 14
347/600VAC 60Hz

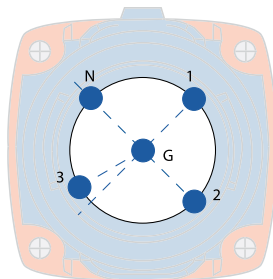

Position 16
120-127VAC/208-220VAC 60Hz

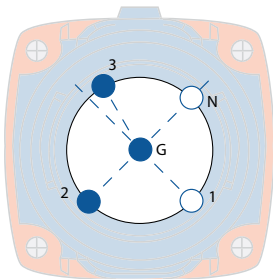

Position 10
110-130VDC

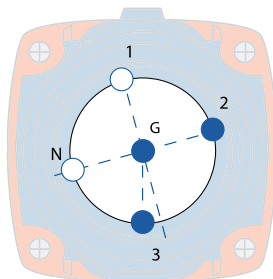

Position 20
220-250VDC

Note: See chart on page 14 for a complete list of voltage polarization positions and associated voltages.

Dual Voltages Devices Maximize User Flexibility

Some MELTRIC receptacles are designed to safely allow dual voltage capabilities.

For example, a 208V rated 3P+N+G receptacle will safely provide power to several configurations of 208V plugs and a single phase 120V plug. Having two voltages delivered by a single receptacle allows some facilities to significantly reduce the number of receptacles that need to be installed.

Dual voltage receptacles are supplied with dual color coded voltage stickers.

Dual Voltages Typically Available from MELTRIC

125/250V

120/208V

277/480V

347/600V

How to Identify Keying Positions of an Existing Device

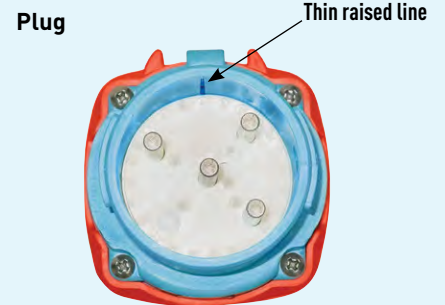

The keying position of most MELTRIC plugs can be determined by looking at the plug interior and finding a thin, raised line in the casing. This line is always directly above a number that identifies the plug's keying position.



The keying position for most receptacles can be determined by identifying a raised arrowhead (usually on the pawl or on the casing next to the pawl). This arrow points to a key number that can be found on the ring that surrounds the safety shutter.

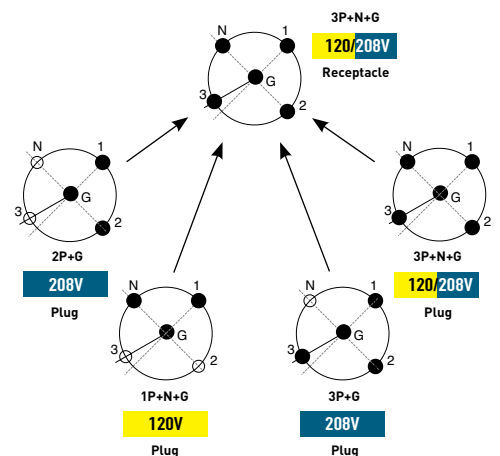

DEVICE MATERIALS AND THEIR RESISTANCE TO ENVIRONMENTS AND CHEMICALS

Polymeric Materials

Casings – The common technical name for the “Poly” material used by MELTRIC is PBT or PBTP (Polybutylene Teraphthalate). It consists of a special blend of thermo-plastic polyester, fiberglass and elastomers which provides outstanding resistance to most chemical agents and environmental conditions, including UV and gamma rays. This material also offers high impact resistance across a broad spectrum of temperatures (shock resistance ratings to IK08).

Interiors – The arc chambers for most MELTRIC devices are made of Melamine or of a special compound of thermoplastic polyester, fiberglass, and elastomer. Other materials are used such as Polyamide and Bakelite.

Accessories – Handles, angles and wall boxes are made of Polyamide (they are supplied with self tapping screws).

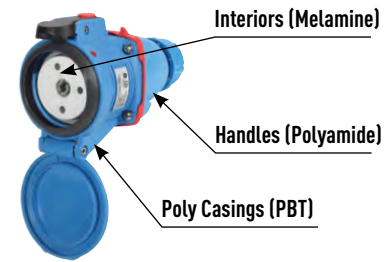

Products with Poly (PBT) casings

DSN20, DSN30, DSN60, DSN150

DS20, DS30, DS60, DS100, DS100C

DR30, DR50, DR100, DR150

DXN20, DXN30, DXN60

DSN24c, DSN37c, DS7, DR7

see note on following page

Resistance of Polymeric Casings to Various Chemical Agents *

Agent	Polyester reinforced glass fiber			Polyamide		
	23°C	60°C	80°C	23°C	60°C	80°C
Butyl acetate	☆☆	☆☆		☆☆		
Ethyl acetate	☆			☆☆		
Acetone	☆			☆☆		
Acetic acid	5%	☆☆	☆☆	☆	☆	-
	10%	☆☆	☆	☆	-	-
Hydrochloric acid	10%	☆☆	☆☆	☆☆	☆	-
Chromic acid	40%	☆☆	☆☆	☆☆	-	-
Citric acid	10%	☆☆	☆☆	☆☆	☆	
Formic acid	5%	☆☆	☆	☆	☆	
Nitric acid	10%	☆☆	☆	☆	-	
Oleic acid	100%	☆☆	☆☆	☆☆	☆	
Phosphoric acid	3%	☆☆	☆☆	☆☆	☆	
	30%	☆☆	☆☆	☆☆	-	-
	85% (conc)	☆☆	☆☆	☆☆	-	-
Sulphuric acid	3%	☆☆	☆☆	☆☆	-	-
	30%	☆☆	☆☆	☆☆	-	-
Ethyl alcohol		☆☆		☆☆		
Methyl alcohol		☆☆		☆☆		
Aniline		☆☆		-		
Benzene		☆	☆	☆☆		
Soda Bicarbonate	10%	☆☆	☆	-	☆☆	☆☆
Potassium bichromate	10%		☆☆		☆☆	
Sodium bisulphate	10%	☆☆	☆	-	☆☆	☆
Butane		☆☆		☆☆		
Butanol		☆	☆	☆		
Soda carbonate	10%	☆☆	-	-	☆☆	☆☆
	20%	☆☆	-	-	☆☆	☆☆
Disulphuric carbonate		☆☆		☆☆		
Calcium chloride	10%	☆☆	☆☆		☆☆	
Potassium chloride	10%	☆☆	☆	-	☆☆	
Sodium chloride	10%	☆☆	☆	-	☆☆	
Detergents	1%	☆☆	☆	-	☆☆	☆
	25%	☆☆	☆	-	☆☆	☆
Dibutylphtalate		☆☆	☆☆		☆☆	
Dichlorethane		-		☆☆		
Dioxane		☆☆	-	☆☆		
Water		☆☆	☆	-	☆☆	☆☆
Bleach		☆☆	☆		☆☆	
Gas		☆☆			☆☆	
Turpentine		☆☆			☆☆	

Agent	Polyester reinforced glass fiber			Polyamide		
	23°C	60°C	80°C	23°C	60°C	80°C
White spirit		☆☆			☆☆	
Ether		☆☆			☆☆	
Freon 11		☆☆			☆☆	
Glycerine		☆	☆		☆☆	☆
Glycol		☆	☆		☆☆	☆
Grease		☆☆	☆☆	☆☆	☆☆	☆☆
Heptane		☆☆			☆☆	
Hexane		☆☆			☆☆	
Cotton seed oil		☆☆	☆☆	☆☆	☆☆	☆☆
Silicon oil		☆☆	☆☆	☆☆	☆☆	☆☆
Processing oil		☆☆	☆☆	☆☆	☆☆	☆☆
Diesel oil		☆☆			☆☆	
Olive oil		☆☆	☆☆	☆☆	☆☆	☆☆
Mineral oil		☆☆	☆☆	☆☆	☆☆	☆☆
Engine oil		☆☆	☆☆	☆☆	☆☆	☆☆
Plant oil		☆☆	☆☆	☆☆	☆☆	☆☆
Ammonium hydroxide	10%	☆			☆☆	
	conc	-			☆☆	
Potassium hydroxide	1%	-	-	-	☆☆	
	10%	-	-	-	☆☆	
Sodium hydroxide	1%	-	-	-	☆☆	
	10%	-	-	-	☆☆	
Calcium hypochlorite		☆☆	☆☆		☆☆	
Sodium hypochlorite	10%	☆☆	☆	-	-	
Isopropanol		☆	☆		☆	
Braking liquid		☆☆	☆☆	☆☆	☆☆	
Methylethycetone		☆☆	☆		☆☆	
Perchlorethylene		☆☆	☆☆		☆☆	☆
Potassium permanganate	10%	☆☆			-	
Oil		-			-	
Hydrogen peroxide	3%	☆☆			-	
	30%	☆☆			-	
Soap solution	1%	☆☆	-	-	☆☆	
Carbon tetrachloride		☆☆			☆☆	
Tetrahydrofurane		☆			☆	
Toluene		☆☆			☆☆	
Trichlorethylene		☆			☆☆	☆
Vaseline		☆☆	☆☆	☆☆	☆☆	☆☆
Xylene		☆☆			☆☆	

Legend: ☆☆☆ = Excellent ☆ = Good - = Poor

Metal Materials

Casings – Metal casings providing even greater impact resistance are standard on some MELTRIC products and are optional on others. Depending upon the product line, these casings may be made of zamak, aluminum or stainless steel. Zamak, a zinc - aluminum alloy is the most commonly used. Zamak receptacles are blue epoxy coated and zamak plugs are specially treated to further improve corrosion resistance.

Contacts – All MELTRIC contact surfaces are made of solid silver-nickel with the exception of the PF and PFQ contacts which are solid pure silver. Silver-nickel and silver both provide excellent resistance to climatic conditions and to all known chemical agents found in industry with the exception of sulphuric acid. Products installed in sulphuric acid environments should have an environmental rating of at least Type 4X or IP66.

Accessories – Wall boxes, angles, and handles are in zamak or aluminum alloy. All zamak accessories are standardly protected by an epoxy paint.

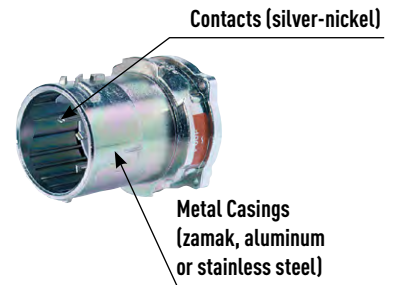

Products with Metal Zamak casings

DS60, DS100C, DS100, DS200, DSN150

DSN150

DB30, DB60, DB100

DR100, DR150, DR250

PN7c, PN12c, DN7c, DN20c, DS7c, DR7c

Products with Aluminum casings

PN (HT)

DX20, DX30, DX60, DX100

PFQ300, PF300, PF400, PF600

Products with Stainless Steel casings

PN7c, PN12c

DS24c, DS37c

Contact customer service for availability of Stainless Steel on other products.

Resistance of Metal Casings to Corrosive Agents *

Agent	Protected Zamak or Aluminum
Dry lighting gas	☆☆
Water steam	☆
Hot water	☆
Artificial sea water	☆
Soluble oil 3%	☆
Soluble oil 5%	☆☆
Cleansing soap	☆☆
Potash solution 1%	☆
Potash solution 5%	☆
Ammonia 1%	☆
Ammonia 5%	☆
Sodium chloride 1%	☆
Sodium chloride 5%	☆
Acetic acid 1%	☆
Acetic acid 5%	–
Gas	☆☆
Engine oil	☆☆
Printing ink	☆
Ethyl or methyl alcohol	☆☆
Trichloethylene	☆
Dry insecticides	☆

Legend: ☆☆ = Excellent ☆ = Good – = Poor

These resistance charts are intended to give a general overview of the performance of our casings and mounting accessories. It is not intended to provide a guarantee of performance of our product as that will depend on the concentration of the chemical, the application temperature, the duration of the exposure, and other application specific factors. In cases where chemical compatibility may be in question the established practice is to place a representative sample device in the application environment to see how it holds up.



WATERTIGHTNESS/INGRESS PROTECTION (NEMA AND IP RATINGS)

Environmental Ratings for MELTRIC Devices



Most MELTRIC products achieve rated watertightness as soon as the plug is fully inserted into the receptacle. The primary exception is the DB product line which requires the turning of a locking ring.

Product	Type	IP (plug+receptacle)	IP (receptacle alone)
DSN	4X	69k	69k
DS*	3R	-	-
DB	-	67	67
DXN	-	66/67	66/67
DXN25c/37c	-	66/67	66/67
DX	-	65	65
DN	-	54	55
PF/PFQ	-	66/67	66/67
DR*	3R	-	-
PN	-	66/67	66/67
PXN12c	-	65/66	65/66
SP	-	66/67	66/67
SPeX	-	66	66

* Additional watertightness is available on DS and DR devices, see pg 233.

Environmental Ratings Explained

NEMA/UL/CSA Enclosure Types (UL50)

Enclosure Type	Intended Use and Description
1	Indoor use primarily to provide a degree of protection against limited amounts of falling dirt.
2	Indoor use primarily to provide a degree of protection against limited amounts of waste and falling dirt.
3, 3R, 3S	Outdoor use primarily to provide a degree of protection against rain, sleet, and damage from external ice formation
4, 4X	Indoor or outdoor use primarily to provide a degree of protection against windblown dust and rain, splashing water, hose-directed water, and damage from external ice formation.
12	Indoor use primarily to provide a degree of protection against circulating dust, falling dirt and dripping non-corrosive liquids.

IP Ratings (IEC/EN 60529)

First Digit Protection against the ingress of solid foreign objects and access to hazardous parts			Second Digit Protection against the ingress of water with harmful effects	
0	No protection		0	No protection
1	50mm	Back of hand	1	Vertically dripping water (condensation)
2	12.5mm	Finger	2	Dripping water at 15°
3	2.5mm	Tool	3	Spraying water at 60° (rain)
4	1mm	Wire	4	Splashing water from any direction
5	Against Dust	-	5	Jetting water from any direction
6	Dust-tight	-	6	Powerful jetting water from any direction
-			7	Temporary submersion

IMPACT RESISTANCE

MELTRIC product resistance to mechanical shocks is specified in accordance with their IK ratings.

MELTRIC Products IK Ratings (per IEC/EN 50102)

Product	Material	IK Ratings
DSN	Poly	08 (5 Joules)
DS	Poly	08 (5 Joules)
DS	Metal	09 (10 Joules)
DB	Metal	09 (10 Joules)
DR	Poly	08 (5 Joules)
DR	Metal	09 (10 Joules)
DN	Metal	09 (10 Joules)
PN	Poly	08 (5 Joules)
PN/PXN12c	Metal	09 (10 Joules)
PF	Metal	10 (20 Joules)
DX	Metal	10 (20 Joules)
DXN	Poly	08 (5 Joules)
DXN25c/37c	Metal	09 (10 Joules)
SP/SPeX	Poly	08 (5 Joules)



OPERATING TEMPERATURES

All MELTRIC plugs and receptacles (except SPeX) can be used with no particular precaution from -15°F to 140°F/-26°C to 60°C.

Hot Temperatures

Some devices that do not contain any polyamide can operate up to 175°F/80°C but precise conditions and duty cycles must be submitted to the MELTRIC engineering department for approval. A limited range of products are available for ambient temperatures up to 465°F/240°C. Contact MELTRIC customer service for more information.

Cold Temperatures

Below -15°F materials become more brittle and impact should be avoided, especially on polyamide materials. However, MELTRIC's metal and polyester casings can be used as low as -40°F/-40°C and some MELTRIC devices are in service at -75°F/-60°C. Consult factory for more information.

Note: SPeX temperature range Min -4°F/Max 140°F

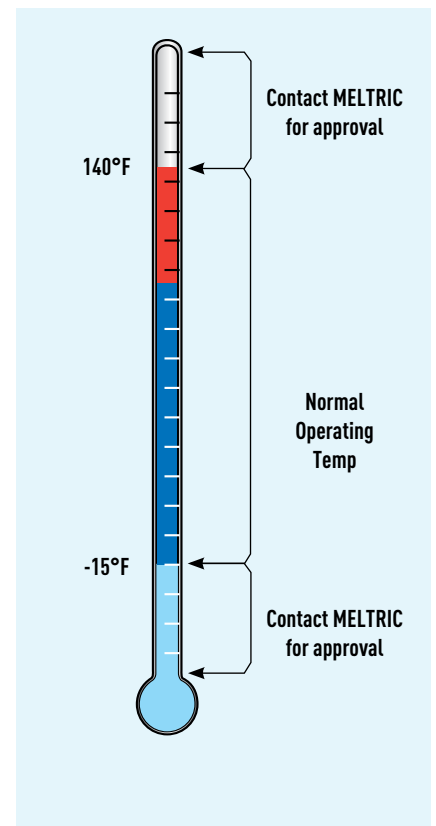

COLOR CODED GASKETS & LABELS FOR VOLTAGE IDENTIFICATION

PIN CONFIGURATION	VOLTAGE RANGE	FREQUENCY	5th, 6th and 7th PART NUMBER DIGITS	RECEPTACLE/CONNECTOR		PLUG/INLET	
				COLOR GASKET	VOLTAGE STICKER	COLOR GASKET	VOLTAGE STICKER
1P+N+G	110 - 125V	60Hz	075	ORANGE	ORANGE	ORANGE	ORANGE
	120 - 127V	60Hz	165	YELLOW	YELLOW	YELLOW	YELLOW
	255 - 277V	60Hz	045	GREY	GREY	GREY	GREY
	347V	60Hz	145	RED	RED	RED	RED
	110 - 130V	50Hz	035	YELLOW	YELLOW	YELLOW	YELLOW
	220 - 250V	50Hz	015	BLUE	BLUE	BLUE	BLUE
	380 - 440V	50Hz	195	RED	RED	RED	RED
	577V	50Hz	225	BLACK	BLACK	BLACK	BLACK
	115 - 127V	200Hz	125	GREEN	YELLOW	GREEN	YELLOW
	115 - 127V	400Hz	115	GREEN	YELLOW	GREEN	YELLOW
2P	20 - 24V	60Hz	02A	VIOLET	VIOLET	VIOLET	VIOLET
	20 - 24V	50Hz	08A	VIOLET	VIOLET	VIOLET	VIOLET
	25 - 28V	50Hz	06A	VIOLET	VIOLET	VIOLET	VIOLET
	40 - 48V	50Hz	13A	WHITE	WHITE	WHITE	WHITE
2P+G	208 - 220V	60Hz	162	BLUE	BLUE	BLUE	BLUE
	220 - 250V	60Hz	072	ORANGE	ORANGE	ORANGE	ORANGE
	440 - 480V	60Hz	042	RED	RED	RED	RED
	600V	60Hz	142	BLACK	BLACK	BLACK	BLACK
	190 - 230V	50Hz	032	BLUE	BLUE	BLUE	BLUE
	380 - 440V	50Hz	012	RED	RED	RED	RED
	480 - 500V	50Hz	092	BLACK	BLACK	BLACK	BLACK
	660 - 690V	50Hz	192	BLACK	BLACK	BLACK	BLACK
	1000V	50Hz	222	BLACK	BLACK	BLACK	BLACK
	200 - 220V	200Hz	122	GREEN	BLUE	GREEN	BLUE
	200 - 220V	400Hz	112	GREEN	BLUE	GREEN	BLUE
	110 - 130V	DC	109	YELLOW	YELLOW	YELLOW	YELLOW
	220 - 250V	DC	209	BLUE	BLUE	BLUE	BLUE

PIN CONFIGURATION	VOLTAGE RANGE	FREQUENCY	5th, 6th and 7th PART NUMBER DIGITS	RECEPTACLE/CONNECTOR		PLUG/INLET		
				COLOR GASKET	VOLTAGE STICKER	COLOR GASKET	VOLTAGE STICKER	
2P+N+G	<u>110 - 125V</u> 220 - 250V	60Hz	076	ORANGE	ORANGE	ORANGE	ORANGE	
	<u>120 - 127V</u> 208 - 220V	60Hz	166	BLUE	YELLOW BLUE	BLUE	YELLOW BLUE	
	<u>255 - 277V</u> 440 - 480V	60Hz	046	RED	GREY RED	RED	GREY RED	
	347 - 600V	60Hz	146	BLACK	RED BLACK	BLACK	RED BLACK	
	<u>110 - 130V</u> 190 - 230V	50Hz	036	BLUE	YELLOW BLUE	BLUE	BLUE	
	<u>220 - 250V</u> 380 - 440V	50Hz	016	RED	BLUE RED	RED	RED	
	<u>380 - 400V</u> 660 - 690V	50Hz	196	BLACK	RED BLACK	BLACK	BLACK	
	480 - 500V	50Hz	096	BLACK	BLACK	BLACK	BLACK	
	<u>115 - 127V</u> 200 - 220V	200Hz	126	GREEN	YELLOW BLUE	GREEN	BLUE	
	<u>115 - 127V</u> 200 - 220V	400Hz	116	GREEN	YELLOW BLUE	GREEN	BLUE	
	3P+G	208 - 220V	60Hz	163	BLUE	BLUE	BLUE	BLUE
		220 - 250V	60Hz	073	ORANGE	ORANGE	ORANGE	ORANGE
		440 - 480V	60Hz	043	RED	RED	RED	RED
		600V	60Hz	143	BLACK	BLACK	BLACK	BLACK
190 - 230V		50Hz	033	BLUE	BLUE	BLUE	BLUE	
380 - 440V		50Hz	013	RED	RED	RED	RED	
480 - 500V		50Hz	093	BLACK	BLACK	BLACK	BLACK	
660 - 690V		50Hz	193	BLACK	BLACK	BLACK	BLACK	
1000V		50Hz	223	BLACK	BLACK	BLACK	BLACK	
200 - 220V		200Hz	123	GREEN	BLUE	GREEN	BLUE	
200 - 220V	400Hz	113	GREEN	BLUE	GREEN	BLUE		
3P+N+G	<u>110 - 125V</u> 220 - 250V	60Hz	077	ORANGE	ORANGE	ORANGE	ORANGE	
	<u>120 - 127V</u> 208 - 220V	60Hz	167	BLUE	YELLOW BLUE	BLUE	YELLOW BLUE	
	<u>255 - 277V</u> 440 - 480V	60Hz	047	RED	GREY RED	RED	GREY RED	
	347 - 600V	60Hz	147	BLACK	RED BLACK	BLACK	RED BLACK	
	<u>110 - 130V</u> 190 - 230V	50Hz	037	BLUE	YELLOW BLUE	BLUE	BLUE	
	<u>220 - 250V</u> 380 - 440V	50Hz	017	RED	BLUE RED	RED	RED	
	<u>380 - 400V</u> 660 - 690V	50Hz	197	BLACK	RED BLACK	BLACK	BLACK	
	480 - 500V	50Hz	097	BLACK	BLACK	BLACK	BLACK	
	<u>115 - 127V</u> 200 - 220V	200Hz	127	GREEN	YELLOW BLUE	GREEN	BLUE	
	<u>115 - 127V</u> 200 - 220V	400Hz	117	GREEN	YELLOW BLUE	GREEN	BLUE	
	MULTIPIN	NOT SPECIFIED			SKY BLUE	SKY BLUE	SKY BLUE	SKY BLUE

SUFFIXES

Quick Reference Table

Suffix	Description	Applicable Products	Special Instructions
-001	Reverse interior for PN, DSN24, DSN37 device only	PN, DSN24, DSN37	Add to inlet and receptacle part numbers
-026	Black device gasket	DS, DR, DSN	
-080	Junction box with angle	All	
-1	1" NPT thread size for conduit entry	DSN, DS, DR, DX, PN, DN, DB	Add to applicable accessories
-112	1 1/2" NPT thread size for conduit entry	DSN, DS, DR, DX, DN, DB	Add to applicable accessories
-12	1/2" NPT thread size for conduit entry	DS, DR, DX, DN, DB	Add to applicable accessories
-114	1 1/4" NPT thread size for conduit entry	DSN, DS, DR, DX, PN, DN, DXN, DB	Add to applicable accessories
-172	Two auxiliary pilot contacts	Select DSN, DS, DR models	Add to inlet & receptacle part number
-173	Three auxiliary pilot contacts	Select DSN, DS, DR models	Add to inlet & receptacle part number
-174	Four auxiliary pilot contacts	Select DSN, DS, DR models	Add to inlet & receptacle part number
-175	Five auxiliary pilot contacts	Select DSN, DS, DR models	Add to inlet & receptacle part number
-180	180° lid opening for flush mounted inlets	DS100, DS200, DR150, DR250	Add to receptacle part number
-185	High temp product	PN	Add to inlet or receptacle part number
-2	2" NPT thread size for conduit entry	DS, DR, DX, DN, DB	Add to applicable accessories
-200	Cable range for PF/PFQ Handle 2.000" - 2.125"	PF/PFQ	Add to handle part number
-20	2" NPT fitting size	PF/PFQ	Add to PF/PFQ junction box
-20P	Cable range .28" - .41"	DXN20, DXN30	Add to plug/connector part number
-212	2 1/2" NPT thread size for conduit entry	DS, DR, DN	
-225	Cable range for PF/PFQ Handle 2.125" - 2.375"	PF/PFQ	Add to handle part number
-237	Cable range for PF/PFQ Handle 2.25" - 2.375"	PF/PFQ	Add to handle part number
-25	2 1/2" NPT fitting size	PF/PFQ	Add to PF/PFQ junction box
-25P	Cable range .35" - .67"	DXN	Add to plug/connector part number
-250	Cable range for PF/PFQ Handle 2.375" - 2.25"	PF/PFQ	Add to handle part number
-262	Two auxiliary pilot contacts	Select DSN, DS, DR models	Add to inlet & receptacle part number
-263	Three auxiliary pilot contacts	Select DSN, DS, DR models	Add to inlet & receptacle part number
-264	Four auxiliary pilot contacts	Select DSN, DS, DR models	Add to inlet & receptacle part number
-270	Auxiliary switch for female devices	DS, DS, DR	Add to receptacle part number
-275	Cable range for PF/PFQ Handle 2.5" - 2.75"	PF/PFQ	Add to handle part number
-30	3" NPT fitting size	PF/PFQ	Add to PF/PFQ junction box
-300	Cable range for PF/PFQ Handle 2.75" - 3"	PF/PFQ	Add to handle part number
-30A	30A capacity for PN devices	PN	Add to inlet & receptacle part number
-312	Cable range for PF/PFQ Handle 3" - 3.125"	PF/PFQ	Add to handle part number
-32P	Cable range .43" - .83"	DXN	Add to plug/connector part number
-335	Cable range for PF/PFQ Handle 3.125" - 3.35"	PF/PFQ	Add to handle part number
-338	PRL release pawl	DSN,DS20,DS30,DS60,DS100C,DS100,DN	Add to inlet part number
-338-A188	PRL release pawl with straight insertion	DS200	Add to inlet part number
-34	3/4" NPT thread size for conduit entry	DSN, DS, DR, DX, PN, DN, DXN, DB	Add to applicable accessories
-352	Straight insertion	DSN,DS20,DS30,DS60,DS100C,DS100,DN	Add to inlet part number
-354	SRL release pawl w/straight insertion for receptacles	DSN,DS20,DS30,DS60,DS100C,DS100,DN	Add to receptacle part number

Suffix	Description	Applicable Products	Special Instructions
-35	3 1/2" NPT fitting size	PF/PFQ	Add to PF/PFQ junction box
-350	Cable range for PF/PFQ Handle 3.35" - 3.5"	PF/PFQ	Add to handle part number
-375	Mushroom Pawl	DSN, DS, DR	Add to receptacle part number
-375-843	Padlockable Mushroom Pawl	DSN, DS, DR, DN	Add to receptacle part number
-3NF	Non functioning contact to activate auxiliary switch	DSN, DS	Activates 2 Pole 4 Wire receptacle
-40	4 NPT fitting size	PF/PFQ	Add to PF/PFQ junction box
-40P	Cable range .75" - 1.10"	DXN	Add to plug/connector part number
-473	Finger drawplate on handle	DS	Add to handle part number
-48	Inlet or receptacle without cap	PF, DB	Add to inlet and receptacle part numbers
-4X	Type 4X watertightness	DS, DR	
-601	Special adapter plate for DSN1 angle on junction box	DSN20	
-824	Metal pawl for poly receptacles	DSN, DS, DR	
-824-300	Locking pawl	PN	Add to receptacle part number
-843	Padlock pawl	DSN, DS, DR	Add to receptacle part number
-845	Oversize padlock pawl	DS, DR	Add to receptacle part number
-924	Metal pawl for poly receptacles	DXN	Add to receptacle part number
-972	Two auxiliary pilot contacts	Select DSN, DS, DR models	Add to inlet and receptacle part numbers
-973	Three auxiliary pilot contacts	Select DSN, DS, DR models	Add to inlet and receptacle part numbers
-974	Four auxiliary pilot contacts	Select DSN, DS, DR models	Add to inlet and receptacle part numbers
-975	Five auxiliary pilot contacts	Select DSN, DS, DR models	Add to inlet and receptacle part numbers
-976	Six auxiliary pilot contacts	Select DSN, DS, DR models	Add to inlet and receptacle part numbers
-A06	Allows up to 4/0 AWG wiring capacity	DS200, DR250	Add to inlet and receptacle part numbers
-A155	Inlet without the standard lockout hole	DSN, DS	Add to inlet part number
-A188	Straight insertion	DS200	Add to inlet and receptacle part numbers
-B	Bottom interior piece	All	
-CG	Cable guide for PRL or SRL release pawl for handle	DSN, DS, DN	Add to handle part number
-C-***	Suffixes for DS100C inlets & receptacles	DS	Included in inlet/receptacle part number
-E323	Allows up to 2/0 AWG wiring capacity	DS100, DR150	
-HP	High pressure water protection	DN	Add to inlet and receptacle part numbers
-K**	Voltage being used when notching position is not standard	All	Add to inlet and receptacle part numbers
-LC	Less cover	DSN, DS	Add to receptacle part number
-MTR	Phase Rotation Meter	DSN, DS, DR, DB	Add to plug
-NC	Normally closed lid	DSN, DS, DR, DN	Add to receptacle part number
-NNF	Non functioning neutral - activates 3 Pole 4 Wire receptacle	DSN, DS, DR	Add to inlet part number
-NP	No paint on accessories	All accessories	
-R	Normally closed lid	DXN	Add to receptacle part number
-SS	Stainless Steel	PN7, PN12, DS	
-T	Top Interior piece	All	

OLD/NEW ACCESSORIES REFERENCES

Old Part Number	New Part Number	Old Part Number	New Part Number	Old Part Number	New Part Number
01-NA013	511P0D18	19-1A953-32M	593P032M	31-1A013	512P0D21
01-NA013-1	511P0N10	19-3A013	514P0D35	31-1A053	512B3M20
01-NA013-12	511P0N05	19-3A053	594B2M25	31-1A053-080-1	712C3N10
01-NA013-34	511P0N07	19-3A253-32P	514P032P	31-1A053-080-112	712C3N15
01-NA023-12	511B3N05	19-6A013-1	595P0N10	31-1A053-080-114	712C3N12
01-NA023-34	511B3N07	19-6A013-112	595P0N15	31-1A053-080-12	712C3N05
01-NA025-12	511B0N05	19-6A013-114	595P0N12	31-1A053-080-34	712C3N07
01-NA025-34	511B0N07	19-6A013-2	595P0N20	31-1A083	512B3M25
01-NA027-601	511M3	19-6A013-34	595P0N07	31-1A253-25P	512P025P
01-NA053-080-1	711C3N10	19-6A053	595B2M40	31-1A443-25P	512P025P443
01-NA053-080-112	711C3N15	19-6A253-32P	515P032P	31-1A753	512P020P
01-NA053-080-114	711C3N12	19-6A953-32M	595P032M	31-1A953-32M	592P032M
01-NA053-080-12	711C3N05	19-9A253-40P	515P040P	31-3A027	513M3
01-NA053-080-34	711C3N07	1H12SS	7X2P0N05	31-3A053	513B3M25
01-NA055	511B0M20	1H1SS	7X2P0N10	31-3A053-080-1	713C3N10
01-NA313	511P6D18	1H34SS	7X2P0N07	31-3A053-080-112	713C3N15
04-2A090-5-10	751P9N10	1PH1	512P0N10	31-3A053-080-114	713C3N12
04-2A090-5-12	751P9N05	1PH114	512P0N12	31-3A053-080-12	713C3N05
04-2A090-5-34	751P9N07	1PH12	512P0N05	31-3A053-080-34	713C3N07
09-2A013-SS-34	7X1P0N07	1PH12M	552P0N05	31-3A473	513P0D30473
09-2A025-185-12	571B0N05185	1PH34	512P0N07	31-3A653-417	513C3M20
09-2A025-185-34	571B0N07185	1PH34M	552P0N07	31-3A753	513P025P
09-2A027-185	571M4185	1PM511	712P0S11	31-3A953-32M	593P032M
09-2A053-185-34	571C4N07185	1PM514	712P0S14	31-6A013	514P0D35
09-2A673-185	571C4M32185	1PM514CG	712P0S14443	31-6A027	514M3
09-2A674-185	571P025M185	1PM516	712P0S16	31-6A053-080-1	714C3N10
09-2A675-185	571P032M185	1PM516CG	712P0S16443	31-6A053-080-112	714C3N15
09-2A913-67	571P020M185	1PM518	712P0S18	31-6A053-080-114	714C3N12
09-2A963-185	571P020M185	1PM520	712P0S20	31-6A053-080-2	714C3N20
09-NA025-12	591B0N05	1PM522	712P0S22	31-6A253-25P	514P025P
09-NA025-34	591B0N07	1PM522CG	712P0S22443	31-6A253-32P	514P032P
09-NA027	591M4	2H1	596P0N10	31-6A473	514P0D35473
09-NA053-080-1	791C4N10	2H112	596P0N15	31-6A753	514P040P
09-NA053-080-114	791C4N12	2H114	596P0N12	31-9A027	515M3
09-NA053-080-114-185	771C4N12185	2H2	596P0N20	31-9A053-080-1	715C3N10
09-NA053-080-1-185	771C4N10185	2H212	596P0N25	31-9A053-080-112	715C3N15
09-NA053-080-12	791C4N05	2H3	596P0N30	31-9A053-080-114	715C3N12
09-NA053-080-12-185	771C4N05185	2H941	596P0D00941	31-9A053-080-2	715C3N20
09-NA053-080-34	791C4N07	2H942	596P0D00942	31-9A053-080-212	715C3N25
09-NA053-080-34-185	771C4N07185	2H943	596P0D00943	31-9A053-080-34	715C3N07
09-NA055	591B0M20	2PH1	516P0N10	31-9A953-63M	595P063M
09-NA953-32M	591P032M	2PH112	516P0N15	35-1A953-25M	5K2P025M
09-NA963	591P020M	2PH112CG	516P0N15443	35-2A013-D35	556P0D35
11-8A013	512P0D21	2PH114	516P0N12	35-2A013-D45	556P0D45
19-1A013	513P0D30	2PH2	516P0N20	35-2A013-D49	556P0D49
19-1A053	593B2M20	2PH212	516P0N25	35-6A053-080-112	7K4C0N15

Old Part Number	New Part Number
35-6A473	554P0D35473
35PH1	7K3P0N10
35PH114	7K3P0N12
35PM516	7K3P0S16
35PM522	7K3P0S22
39-1A053-080-SS-1	7X2C3N10
39-1A127	592M0
39-2A053	596E6M63
39-2A053-080-112	796C6N15
39-2A053-080-114	796C6N12
39-2A053-080-2	796C6N20
39-2A053-080-212	796C6N25
39-2A753	516P063P
39-2A913	596P0D54
39-2A953-429	596P0M50
39-2A953-463	596P0M63
39-3A053-080-1	793C3N10
39-3A053-080-114	793C3N12
39-3A053-080-12	793C3N05
39-3A053-080-34	793C3N07
39-3A053-080-SS-1	7X3C3N10
39-3A127	593M0
39-4A025-63M	577C763M
39-4A027-68	5T7M6
39-4A127	5T7M0
39-4A127-115	5T7M0-115
39-4A127-68	5T7M0-68
39-4A915-57	5T7P0D57
39-4A915-62	5T7P0D62
39-4A915-68	5T7P0D68
39-4A915-73	5T7P0D73
39-6A013	514P0D35
39-6A053	594B2M40
39-6A053-080-1	794C3N10
39-6A053-080-112	794C3N15
39-6A053-080-114	794C3N12
39-6A053-080-2	794C3N20
39-6A127	594M0
39-9A053-080-1	795C3N10
39-9A053-080-112	795C3N15
39-9A053-080-112M	7K5C3N15
39-9A053-080-114	795C3N12
39-9A053-080-114M	7K5C3N12
39-9A053-080-2	795C3N20
39-9A053-080-212	795C3N25
39-9A053-080-2M	7K5C3N20

Old Part Number	New Part Number
39-9A053-080-34	795C3N07
39-9A127	595M0
39-9A653	595C3M50
3H1	593P0N10
3H112	593P0N15
3H112SS	7X3P0N15
3H114	593P0N12
3H114SS	7X3P0N12
3H12	593P0N05
3H12SS	7X3P0N05
3H1SS	7X3P0N10
3H2	593P0N20
3H34	593P0N07
3H34SS	7X3P0N07
3HM32SS	7X3P0M32
3PH1	513P0N10
3PH114	513P0N12
3PH12	513P0N05
3PH34	513P0N07
3PHM1	553P0N10
3PHM114	553P0N12
3PHM12	553P0N05
3PHM25	553P0M25
3PM514	713P0S14
3PM514M	753P0S14
3PM516	713P0S16
3PM518	713P0S18
3PM518CG	713P0S18443
3PM520	713P0S20
3PM520CG	713P0S20443
3PM522	713P0S22
3PM522CG	713P0S22443
3PM522M	753P0S22
4MH2	5T7P0N20
4MH212	5T7P0N25
4MH3	5T7P0N30
51-AA058	511C7000
51-AA058Z0694	511C7Z0694
51-AA757	511M7
51-BA058	512C7000
51-BA757	512M7
51-CA058	513C7000
51-CA757	513M7
51-DA058	514C7000
51-DA757	514M7
59-AA058-1	711C7N10

Old Part Number	New Part Number
59-AA058-112	711C7N15
59-AA058-114	711C7N12
59-AA058-12	711C7N05
59-AA058-34	711C7N07
59-BA058-1	712C7N10
59-BA058-112	712C7N15
59-BA058-114	712C7N12
59-BA058-12	712C7N05
59-BA058-34	712C7N07
59-CA058-1	713C7N10
59-CA058-112	713C7N15
59-CA058-114	713C7N12
59-CA058-12	713C7N05
59-CA058-34	713C7N07
59-DA058-1	714C7N10
59-DA058-112	714C7N15
59-DA058-114	714C7N12
59-DA058-12	714C7N05
59-DA058-34	714C7N07
61-1A013	511P0D18
61-1A013-1	511P0N10
61-1A013-12	511P0N05
61-1A013-34	511P0N07
61-1A013-M20	511P0M20
61-1A023-12	511B3N05
61-1A023-34	511B3N07
61-1A027-601	511M3
61-1A053	511B3M20
61-1A053-080-1	711C3N10
61-1A053-080-114	711C3N12
61-1A053-080-12	711C3N05
61-1A053-080-34	711C3N07
61-1A053-080-M20	711C3M20
61-1A053-417	511B3M20
61-1A253-20M	511P020M
61-1A253-25P	511P025P
61-1A253-417	511P0M20
61-1A313	511P6D18
61-1A413	511P0D21
61-1A653	511C3M20
61-3A013	512P0D21
61-3A013-1	512P0N10
61-3A013-114	512P0N12
61-3A013-12	512P0N05
61-3A013-34	512P0N07
61-3A013-488	512P0D21488

OLD/NEW ACCESSORIES REFERENCES

Old Part Number	New Part Number	Old Part Number	New Part Number	Old Part Number	New Part Number
61-3A023-12	512B3N05	65-6A013-114	553P0N12	89-3A053-080-34	793C7N07
61-3A023-34	512B3N07	65-6A027	553M3	89-6A027	594M7
61-3A027	512M3	65-9A013-D25	555P0D25	89-6A027M	5K4M7
61-3A027-488	512M3488	65-9A013-D35	555P0D35	89-6A053-080-1	794C7N10
61-3A053-080-1	712C3N10	65-9A013-D45	555P0D45	89-6A053-080-112	794C7N15
61-3A053-080-112	712C3N15	65-9A013-D49	555P0D49	89-6A053-080-114	794C7N12
61-3A053-080-114	712C3N12	69-3A127	592M0	89-6A053-080-2	794C7N20
61-3A053-080-12	712C3N05	69-6A013-1-SS	7X3P0N10	89-6A053-080-34	794C7N07
61-3A053-080-34	712C3N07	6H1	594P0N10	89-9A027	595M7
61-3A083	512B3M25	6H112	594P0N15	89-9A027M	5K5M7
61-3A253-25P	512P025P	6H112AL	7A4P0N15	89-9A053-080-1	795C7N10
61-3A253-32P	512P032P	6H112M	5K4P0N15	89-9A053-080-112	795C7N15
61-3A253-417	512P0M20	6H114	594P0N12	89-9A053-080-114	795C7N12
61-3A346-488		6H114M	5K4P0N12	89-9A053-080-114-B&L	795C7N12C7
61-3A653	512C3M20	6H12	594P0N05	89-9A053-080-2	795C7N20
61-3A753	512P020P	6H12M	5K4P0N05	89-9A053-080-34	795C7N07
61-6A013	513P0D30	6H1M	5K4P0N10	9H1	595P0N10
61-6A013-1	513P0N10	6H34	594P0N07	9H112	595P0N15
61-6A013-114	513P0N12	6H34M	5K4P0N07	9H112M	5K5P0N15
61-6A013-12	513P0N05	6PH1	514P0N10	9H114	595P0N12
61-6A013-34	513P0N07	6PH112	514P0N15	9H114M	5K5P0N12
61-6A023-1	513B3N10	6PH114	514P0N12	9H1M	5K5P0N10
61-6A023-12	513B3N05	6PH12	514P0N05	9H2	595P0N20
61-6A023-34	513B3N07	6PH1M	554P0N10	9H2AL	7A5P0N20
61-6A027	513M3	6PH34	514P0N07	9H2-AL	7A5P0N20
61-6A053	513B3M25	6PHM-622	754P0S22	9H2CG	595P0N20443
61-6A053-080-1	713C3N10	6PHM-629	754P0S29	9H2M	5K5P0N20
61-6A053-080-112	713C3N15	6PM622	714P0S22	9H34	595P0N07
61-6A053-080-114	713C3N12	6PM622CG	714P0S22443	9H34M	5K5P0N07
61-6A053-080-12	713C3N05	6PM625	714P0S25	9-LD12-37	61-CA593
61-6A053-080-34	713C3N07	6PM625CG	714P0S25443	9MH1	795P0N10
61-6A253-32P	513P032P	6PM627	714P0S27	9MH112	795P0N15
61-6A253-40P	513P040P	6PM629	714P0S29	9MH112M	7K5P0N15
61-6A473	513P0D30473	87-3A053-420	593C7M40	9MH114	795P0N12
61-6A953-40M	593P040M	87-3A253-32P	513P032P	9MH114M	7K5P0N12
61-6A963	593P025M	87-3A963	593P025M	9MH2	795P0N20
61-9A253-463	515P0M63	87-6A013	514P0D35	9MH212	795P0N25
61-9A253-63P	515P063P	87-6A053	594C7M40	9MH212M	7K5P0N25
65-1A013	551P0D18	87-6A953-50M	594P050M	9MH2M	7K5P0N20
65-1A013-34	551P0N07	87-6A963	594P040M	9MH34	795P0N07
65-1A027-601	551M3	87-9A823-420	595C7M40	9PH1	515P0N10
65-3A013	552P0D21	87-9A963	595P050M	9PH112	515P0N15
65-3A013-1	552P0N10	89-3A027	593M7	9PH114	515P0N12
65-3A027	552M3	89-3A053-080-1	793C7N10	9PH2	515P0N20
65-6A013	553P0D30	89-3A053-080-114	793C7N12	9PH2CG	515P0N20443
65-6A013-1	553P0N10	89-3A053-080-12	793C7N05	9PH34	515P0N07

Old Part Number	New Part Number
9PH34CG	515P0N07443
9PM622	715P0S22
9PM625	715P0S25
9PM627	715P0S27
9PM629	715P0S29
DN63R	19-6A126
FDP2	61-3A346
FDP3	61-6A346
FDP6	31-6A346
FDP9SS	
FH111	512P0D21
FH111-488	512P0D21488
FH111CG	512P0D21443
FH111M	552P0D21
FH311	513P0D30
FH311-473	513P0D30473
FH311-488	513P0D30488
FH311CG	513P0D30443
FH311M	553P0D30
FH311M-473	553P0D30473
FH611	514P0D35
FH611-473	514P0D35473
FH611CG	514P0D35443
FH611M	554P0D35
H091U1	591P0N10
H091U1-185	571P0N10185
H091U12	591P0N05
H091U12-185	571P0N05185
H091U12-SS	7X1P0N05
H091U34	591P0N07
H091U34-185	571P0N07185
H091U34-SS	7X1P0N07
H93DNU112	593P0N15
MA1	591M4
MA10	595M3
MA10M	5K5M3
MA110	795M3
MA2	592M3
MA20	596M6
MA220	796M4
MA2SS	7X2M3
MA3	593M3
MA3SS	7X3M3
MA6	594M3
MA660	794M3
MA6M	5K4M3

Old Part Number	New Part Number
MAB6	794M3L
MAB6M	7K4M3L
MAFS1	791M3FS
MAFS2	792M3FS
MAFS3	793M3FS
MB10	7T5F0000
MB101	7T5F0N10
MB10112	7T5F0N15
MB10112M	7K5F0N15
MB10114	7T5F0N12
MB10114M	7K5F0N12
MB102	7T5F0N20
MB10212	7T5F0N25
MB10212M	7K5F0N25
MB102M	7K5F0N20
MB20	7T6F0000
MB20112	7T6F0N15
MB20114	7T6F0N12
MB202	7T6F0N20
MB20212	7T6F0N25
MB22	7T6F0000XL
MB2202	7T6F0N20XL
MB2203	7T6F0N30XL
MB22212	7T6F0N25XL
MB3-0	7T1F0000
MB31	7T1F0N10
MB3112	7T1F0N15
MB3114	7T1F0N12
MB312	7T1F0N05
MB31-34T	7T1F0C22
MB31SS	7X1F0N10
MB334	7T1F0N07
MB334-12B	7T1F0C9
MB334-SS	7X1F0N07
MB3SS	7X1F0000
MB40DR-20	7T7F0N20
MB40DR-25	7T7F0N25
MB40DR-30	7T7F0N30
MB40DR-35	7T7F0N35
MB40DR-40	7T7F0N40
MB6	7T4F0000
MB6-0	7T4F0000
MB61	7T4F0N10
MB6112	7T4F0N15
MB6112M	7K4F0N15
MB6114	7T4F0N12

Old Part Number	New Part Number
MB6114M	7K4F0N12
MB612	7T4F0N05
MB61M	7K4F0N10
MB62	7T4F0N20
MB62M	7K4F0N20
MB634	7T4F0N07
MB634TB	7T4F0N07C2
MC212	512B3N05
MC234	512B3N07
MC31	513B3N10
MC312	513B3N05
MC334	513B3N07
MC61	514B3N10
MC6114	514B3N12
MC612	514B3N05
MC634	514B3N07
MP10	515M3
MP10M	555M3
MP2	512M3
MP2M	552M3
MP3	513M3
MP3M	553M3
MP6	514M3
MP6M	554M3
MS1	591M0
MS10	595M0
MS10M	5K5M0
MS2	592M0
MS20	596M0
MS3	593M0
MS6	594M0
MS6M	5K4M0
MSPN	591M0
MSPN-185	571M0

PARTS INDEX

Part number	Pg	Part number	Pg	Part number	Pg	Part number	Pg	Part number	Pg
01-2A010	118	01-S4042	116	09-AA920	91	17-14060	82	17-68191	84
01-2A010-185	118	01-S4043	116	09-N4042	116	17-14061	82	19-1A014	90
01-2A010-185-B	118	01-S4045	116	09-N4043	116	17-14070	82	19-1A024	91
01-2A010-185-T	118	01-S4047	116	09-N4045	116	17-14071	82	19-1A126	83
01-2A010-B	118	01-S4072	116	09-N4047	116	17-14080	82	19-1A721	91
01-2A010-T	118	01-S4075	116	09-N4072	116	17-18051	82	19-1A910	90
01-2A011	118	01-S4076	116	09-N4075	116	17-18060	82	19-1A911	90
01-2A011-185	118	01-S4142	116	09-N4076	116	17-18061	82	19-1A920	91
01-2A020	119	01-S4143	116	09-N4142	116	17-18070	82	19-1A921	91
01-2A020-185	119	01-S4147	116	09-N4143	116	17-18071	82	19-1A925	91
01-2A020-185-B	119	01-S4162	116	09-N4147	116	17-18080	82	19-6A126	85
01-2A020-185-T	119	01-S4163	116	09-N4162	116	17-18081	82	19-6A721	91
01-2A020-B	119	01-S4167	116	09-N4163	116	17-18090	82	19-6A910	90
01-2A020-T	119	03-A4001	76	09-N4167	116	17-19190	82	19-6A911	90
01-2A021	119	03-A8001	76	09-N8042	116	17-64091	84	19-6A920	91
01-2A021-185	119	06-A0001	239	09-N8043	116	17-64100	84	19-6A921	91
01-2A142	75	06-A0001-25M	239	09-N8045	116	17-64101	84	19-6A925	91
01-2A126	75	06-A1001	239	09-N8047	116	17-64110	84	22-14042	190
01-AA113	90	06-A1001-25M	239	09-N8072	116	17-64111	84	22-14043	190
01-AA910	90	06-A3001	239	09-N8075	116	17-64120	84	22-14045	190
01-AA920	91	06-A3001-25M	239	09-N8076	116	17-64121	84	22-14047	190
01-N4042	116	06-A6001	239	09-N8142	116	17-64130	84	22-14072	190
01-N4043	116	06-A6001-25M	239	09-N8143	116	17-64131	84	22-14073	190
01-N4045	116	06-A7001	239	09-N8147	116	17-64140	84	22-14075	190
01-N4047	116	06-A9001	239	09-N8162	116	17-64141	84	22-14076	190
01-N4072	116	07-A4001	76	09-N8163	116	17-64150	84	22-14142	190
01-N4075	116	07-A4001-SS	76	09-N8167	116	17-64151	84	22-14143	190
01-N4076	116	07-A8001	76	09-NA014	90	17-64160	84	22-14147	190
01-N4142	116	07-A8001-SS	76	09-NA024	91	17-64161	84	22-14162	190
01-N4143	116	09-04041-SS	74	09-P4041	74	17-64170	84	22-14163	190
01-N4162	116	09-04051-SS	74	09-P4051	74	17-64171	84	22-14165	190
01-N4163	116	09-04061-SS	74	09-P4061	74	17-64180	84	22-14167	190
01-N4167	116	09-08041-SS	74	09-P8041	74	17-64181	84	22-18165	190
01-N8042	116	09-08051-SS	74	09-P8051	74	17-64190	84	22-1A013-12	191
01-N8043	116	09-08061-SS	74	09-P8061	74	17-64191	84	22-1A013-34	191
01-N8045	116	09-24042-185	124	09-PA910	90	17-64200	84	22-1A023-12-B	191
01-N8047	116	09-24043-185	124	09-PA911	90	17-68091	84	22-1A023-12-T	191
01-N8072	116	09-24045-185	124	09-PA919	90	17-68100	84	22-1A023-34-B	191
01-N8075	116	09-24047-185	124	09-PA920	91	17-68101	84	22-1A023-34-T	191
01-N8076	116	09-24072-185	124	09-PA921	91	17-68110	84	22-1A057	191
01-N8142	116	09-24073-185	124	09-PA929	91	17-68111	84	22-1A058-1	191
01-N8143	116	09-24075-185	124	09-S4042	116	17-68120	84	22-1A058-112	191
01-N8147	116	09-24076-185	124	09-S4043	116	17-68121	84	22-1A058-114	191
01-N8162	116	09-24077-185	124	09-S4045	116	17-68130	84	22-1A058-12	191
01-N8163	116	09-28042-185	124	09-S4047	116	17-68131	84	22-1A058-34	191
01-N8167	116	09-28043-185	124	09-S4072	116	17-68140	84	22-1A426	191
01-NA014	90	09-28045-185	124	09-S4075	116	17-68141	84	22-34042	192
01-NA024	91	09-28047-185	124	09-S4076	116	17-68150	84	22-34043	192
01-P4041	74	09-28072-185	124	09-S4142	116	17-68151	84	22-34045	192
01-P4051	74	09-28073-185	124	09-S4143	116	17-68160	84	22-34047	192
01-P4061	74	09-28075-185	124	09-S4147	116	17-68161	84	22-34072	192
01-P8041	74	09-28076-185	124	09-S4162	116	17-68170	84	22-34073	192
01-P8051	74	09-28077-185	124	09-S4163	116	17-68171	84	22-34075	192
01-P8061	74	09-2A014-185	118	09-S4167	116	17-68180	84	22-34076	192
01-PA910	90	09-2A024-185	119	09-SA024	119	17-68181	84	22-34142	192
01-PA920	91	09-AA910	90	17-14051	82	17-68190	84	22-34143	192

Part number	Pg	Part number	Pg	Part number	Pg	Part number	Pg	Part number	Pg
22-34147	192	22-6A023-1-B	195	25-3A253-25M	193	26-20167-XX	230	26-30076-XX	231
22-34162	192	22-6A023-1-T	195	25-3A253-32M	193	26-21042-XXX	230	26-30143-XX	231
22-34163	192	22-6A027	195	25-3A253-32P	193	26-21043-XXX	230	26-30162-XX	231
22-34165	192	22-6A058-1	195	25-3A253-40P	193	26-21045-XXX	230	26-30163-XX	231
22-34167	192	22-6A058-112	195	25-3A753	193	26-21047-XXX	230	26-30167-XX	231
22-38042	192	22-6A058-114	195	25-3A757	193	26-21072-XXX	230	26-31042-XXX	231
22-38043	192	22-6A058-12	195	25-3A783	193	26-21075-XXX	230	26-31043-XXX	231
22-38045	192	22-6A058-34	195	25-3AB53	193	26-21076-XXX	230	26-31045-XXX	231
22-38047	192	25-14013	190	25-3AB53-25P	193	26-21143-XXX	230	26-31047-XXX	231
22-38072	192	25-14015	190	25-3AB88-20P	193	26-21162-XXX	230	26-31072-XXX	231
22-38073	192	25-14017	190	25-3AB88-25P	193	26-21163-XXX	230	26-31075-XXX	231
22-38075	192	25-14033	190	25-3AB88-32P	193	26-21167-XXX	230	26-31076-XXX	231
22-38076	192	25-1408A	190	25-64013	194	26-23042-XXX	230	26-31143-XXX	231
22-38165	192	25-14093	190	25-64015	194	26-23043-XXX	230	26-31162-XXX	231
22-38242	192	25-14097	190	25-64017	194	26-23045-XXX	230	26-31163-XXX	231
22-38243	192	25-18013	190	25-64033	194	26-23047-XXX	230	26-31167-XXX	231
22-38247	192	25-18015	190	25-6408A	194	26-23072-XXX	230	26-33042-XXX	231
22-38262	192	25-18017	190	25-64093	194	26-23075-XXX	230	26-33043-XXX	231
22-38263	192	25-18033	190	25-64097	194	26-23076-XXX	230	26-33045-XXX	231
22-38267	192	25-1808A	190	25-68013	194	26-23143-XXX	230	26-33047-XXX	231
22-3A013-1	193	25-18093	190	25-68015	194	26-23162-XXX	230	26-33072-XXX	231
22-3A013-34	193	25-18097	190	25-68017	194	26-23163-XXX	230	26-33075-XXX	231
22-3A023-34-B	193	25-1A057	191	25-68033	194	26-23167-XXX	230	26-33076-XXX	231
22-3A023-34-T	193	25-1A088-20P	191	25-6808A	194	26-24042	230	26-33143-XXX	231
22-3A027	193	25-1A088-25P	191	25-68093	194	26-24043	230	26-33162-XXX	231
22-3A058-1	193	25-1A253-20M	191	25-68097	194	26-24045	230	26-33163-XXX	231
22-3A058-112	193	25-1A253-25M	191	25-6A027	195	26-24047	230	26-33167-XXX	231
22-3A058-114	193	25-1A253-25P	191	25-6A088-20P	195	26-24072	230	26-34042	231
22-3A058-12	193	25-1A253-32M	191	25-6A088-25P	195	26-24075	230	26-34043	231
22-3A058-34	193	25-1A253-32P	191	25-6A088-32P	195	26-24076	230	26-34045	231
22-64042	194	25-1A753	191	25-6A088-40P	195	26-24143	230	26-34047	231
22-64043	194	25-1A757	191	25-6A253-20M	195	26-24162	230	26-34072	231
22-64045	194	25-1AB53	191	25-6A253-20P	195	26-24163	230	26-34075	231
22-64047	194	25-1AB53-25P	191	25-6A253-25M	195	26-24165	230	26-34076	231
22-64072	194	25-1AB88-20P	191	25-6A253-32M	195	26-24167	230	26-34143	231
22-64073	194	25-1AB88-25P	191	25-6A253-32P	195	26-26042-XX	230	26-34162	231
22-64075	194	25-1AB88-32P	191	25-6A253-40P	195	26-26043-XX	230	26-34163	231
22-64076	194	25-34013	192	25-6A753	195	26-26045-XX	230	26-34167	231
22-64142	194	25-34015	192	25-6A757	195	26-26047-XX	230	26-36042-XX	231
22-64143	194	25-34017	192	25-6AB53	195	26-26072-XX	230	26-36043-XX	231
22-64147	194	25-34033	192	25-6AB88-20P	195	26-26075-XX	230	26-36045-XX	231
22-64162	194	25-3408A	192	25-6AB88-25P	195	26-26076-XX	230	26-36047-XX	231
22-64163	194	25-34093	192	25-6AB88-32P	195	26-26143-XX	230	26-36072-XX	231
22-64165	194	25-34097	192	25-6AB88-40P	195	26-26162-XX	230	26-36075-XX	231
22-64167	194	25-38013	192	26-20042-XX	230	26-26163-XX	230	26-36076-XX	231
22-68042	194	25-38015	192	26-20043-XX	230	26-26167-XX	230	26-36143-XX	231
22-68043	194	25-38017	192	26-20045-XX	230	26-2A023-1	230	26-36162-XX	231
22-68045	194	25-38033	192	26-20047-XX	230	26-2A023-12	230	26-36163-XX	231
22-68047	194	25-3808A	192	26-20072-XX	230	26-2A023-34	230	26-36167-XX	231
22-68072	194	25-38093	192	26-20073-XX	230	26-2A126	230	26-3A023-1	231
22-68075	194	25-38097	192	26-20075-XX	230	26-30042-XX	231	26-3A023-12	231
22-68076	194	25-3A027	193	26-20076-XX	230	26-30043-XX	231	26-3A023-34	231
22-68162	194	25-3A088-20P	193	26-20143-XX	230	26-30045-XX	231	26-3A126	231
22-68163	194	25-3A088-25P	193	26-20162-XX	230	26-30047-XX	231	26-60042-XX	232
22-68167	194	25-3A088-32P	193	26-20163-XX	230	26-30072-XX	231	26-60043-XX	232
22-6A013-1	195	25-3A253-20M	193	26-20165-XX	230	26-30075-XX	231	26-60045-XX	232

PARTS INDEX

Part number	Pg	Part number	Pg	Part number	Pg	Part number	Pg	Part number	Pg
26-60047-XX	232	26-6A126	232	2817047	201	2813047XX	200	31-1A010-T	52
26-60072-XX	232	26-90042-XX	233	2817072	201	2813072XX	200	31-1A011	52
26-60075-XX	232	26-90043-XX	233	2817075	201	2813075XX	200	31-1A014	52
26-60076-XX	232	26-90045-XX	233	2817076	201	2813076XX	200	31-1A020	53
26-60143-XX	232	26-90047-XX	233	2817142	201	2813142XX	200	31-1A020-B	53
26-60162-XX	232	26-90072-XX	233	2817143	201	2813143XX	200	31-1A020-T	53
26-60163-XX	232	26-90075-XX	233	2817147	201	2813147XX	200	31-1A021	53
26-60167-XX	232	26-90076-XX	233	2817162	201	2813162XX	200	31-1A024	53
26-61042-XXX	232	26-90143-XX	233	2817163	201	2813163XX	200	31-1A056	110
26-61043-XXX	232	26-90162-XX	233	2817165	201	2813165XX	200	31-1A226	41
26-61045-XXX	232	26-90163-XX	233	2817167	201	2813167XX	200	31-1A310-972	52
26-61047-XXX	232	26-90167-XX	233	2819042	201	2816042XXY	201	31-1A320-972	53
26-61072-XXX	232	26-93042-XXX	233	2819043	201	2816043XXY	201	31-1A320-C-972	53
26-61075-XXX	232	26-93043-XXX	233	2819045	201	2816045XXY	201	31-1A426	41
26-61076-XXX	232	26-93045-XXX	233	2819047	201	2816047XXY	201	31-1AB26	52
26-61143-XXX	232	26-93047-XXX	233	2819072	201	2816072XXY	201	31-1AC26	52
26-61162-XXX	232	26-93072-XXX	233	2819075	201	2816075XXY	201	31-1AN26	52
26-61163-XXX	232	26-93075-XXX	233	2819076	201	2816076XXY	201	31-1AR26	52
26-61167-XXX	232	26-93076-XXX	233	2819142	201	2816142XXY	201	31-34175-K07	100
26-63042-XXX	232	26-93143-XXX	233	2819143	201	2816143XXY	201	31-34176-K07	100
26-63043-XXX	232	26-93162-XXX	233	2819147	201	2816147XXY	201	31-34183-K14	100
26-63045-XXX	232	26-93163-XXX	233	2819162	201	2816162XXY	201	31-34187-K14	100
26-63047-XXX	232	26-93167-XXX	233	2819163	201	2816163XXY	201	31-34232-K16	100
26-63072-XXX	232	26-94042	233	2819165	201	2816165XXY	201	31-34233-K16	100
26-63075-XXX	232	26-94043	233	2819167	201	2816167XXY	201	31-34235-K16	100
26-63076-XXX	232	26-94045	233	2810042XXY	201	31-14172-K07	98	31-34237-K16	100
26-63143-XXX	232	26-94047	233	2810043XXY	201	31-14173-K07	98	31-34242-K04	100
26-63162-XXX	232	26-94072	233	2810045XXY	201	31-14175-K07	98	31-34243-K04	100
26-63163-XXX	232	26-94075	233	2810047XXY	201	31-14176-K07	98	31-34245-K04	100
26-63167-XXX	232	26-94076	233	2810072XXY	201	31-14182-K14	98	31-34247-K04	100
26-64042	232	26-94143	233	2810075XXY	201	31-14183-K14	98	31-34931	88
26-64043	232	26-94162	233	2810076XXY	201	31-14187-K14	98	31-34940	88
26-64045	232	26-94163	233	2810142XXY	201	31-14232-K16	98	31-34941	88
26-64047	232	26-94167	233	2810143XXY	201	31-14233-K16	98	31-34950	88
26-64072	232	26-9A023-1	233	2810147XXY	201	31-14235-K16	98	31-34951	88
26-64075	232	26-9A023-112	233	2810162XXY	201	31-14237-K16	98	31-34960	88
26-64076	232	26-9A023-114	233	2810163XXY	201	31-14242-K04	98	31-34961	88
26-64143	232	26-9A023-2	233	2810165XXY	201	31-14243-K04	98	31-34970	88
26-64162	232	26-9A126	233	2810167XXY	201	31-14245-K04	98	31-38172-K07	100
26-64163	232	2814042	200	2811042XX	200	31-14247-K04	98	31-38175-K07	100
26-64167	232	2814043	200	2811043XX	200	31-18172-K07	98	31-38176-K07	100
26-66042-XX	232	2814045	200	2811045XX	200	31-18173-K07	98	31-38182-K14	100
26-66043-XX	232	2814047	200	2811047XX	200	31-18175-K07	98	31-38183-K14	100
26-66045-XX	232	2814072	200	2811072XX	200	31-18176-K07	98	31-38187-K14	100
26-66047-XX	232	2814075	200	2811075XX	200	31-18182-K14	98	31-38232-K16	100
26-66072-XX	232	2814076	200	2811076XX	200	31-18187-K14	98	31-38233-K16	100
26-66075-XX	232	2814142	200	2811142XX	200	31-18232-K16	98	31-38235-K16	100
26-66076-XX	232	2814143	200	2811143XX	200	31-18233-K16	98	31-38237-K16	100
26-66143-XX	232	2814147	200	2811147XX	200	31-18235-K16	98	31-38242-K04	100
26-66162-XX	232	2814162	200	2811162XX	200	31-18237-K16	98	31-38243-K04	100
26-66163-XX	232	2814163	200	2811163XX	200	31-18242-K04	98	31-38245-K04	100
26-66167-XX	232	2814165	200	2811165XX	200	31-18243-K04	98	31-38247-K04	100
26-6A023-1	232	2814167	200	2811167XX	200	31-18245-K04	98	31-38931	88
26-6A023-112	232	2817042	201	2813042XX	200	31-18247-K04	98	31-38940	88
26-6A023-114	232	2817043	201	2813043XX	200	31-1A010	52	31-38941	88
26-6A023-2	232	2817045	201	2813045XX	200	31-1A010-B	52	31-38950	88

Part number	Pg	Part number	Pg	Part number	Pg	Part number	Pg	Part number	Pg
31-38951	88	31-68237-K16	102	31-982172-K07	104	33-34058-S82	128	33-38551	86
31-38960	88	31-68242-K04	102	31-98232-K16	104	33-34072	42	33-38560	86
31-38961	88	31-68243-K04	102	31-98233-K16	104	33-34075	42	33-38561	86
31-38970	88	31-68245-K04	102	31-98235-K16	104	33-34076	42	33-38570	86
31-3A010	52	31-68247-K04	102	31-98237-K16	104	33-34109	128	33-61***-MTR	181
31-3A010-B	52	31-6A010	52	31-98242-K04	104	33-34142	42	33-64042	44
31-3A010-T	52	31-6A010-B	52	31-98243-K04	104	33-34143	42	33-64043	44
31-3A011-380	52	31-6A010-C-B	52	31-98245-K04	104	33-34147	42	33-64045	44
31-3A014	52	31-6A010-C-T	52	31-98247-K04	104	33-34158-S69	128	33-64047	44
31-3A020	53	31-6A010-T	52	31-9A026	90	33-34162	42	33-64058-S82	128
31-3A020-B	53	31-6A011	52	31-9A583	111	33-34163	42	33-64072	44
31-3A020-T	53	31-6A011-C	52	31-9AB26	52	33-34165	42	33-64075	44
31-3A021-380	53	31-6A014	52	31-9AC26	52	33-34167	42	33-64076	44
31-3A024	53	31-6A020	53	31-9AN26	52	33-34209	128	33-64109	128
31-3A026	90	31-6A020-B	53	31-9AR26	52	33-34531	86	33-64142	44
31-3A056	110	31-6A020-C	53	31-CA213	91	33-34540	86	33-64143	44
31-3A226	43	31-6A020-C-B	53	33-11***-MTR	181	33-34541	86	33-64147	44
31-3A310-972	52	31-6A020-C-T	53	33-14042	40	33-34550	86	33-64158-S69	128
31-3A320-972	53	31-6A020-T	53	33-14043	40	33-34551	86	33-64162	44
31-3A426	43	31-6A021	53	33-14045	40	33-34560	86	33-64163	44
31-3A910-263	90	31-6A021-C	53	33-14047	40	33-34561	86	33-64165	44
31-3A911	90	31-6A024	53	33-14058-S82	128	33-34570	86	33-64167	44
31-3A919	90	31-6A066	110	33-14072	40	33-37042-12X	171	33-64175-C-K07	46
31-3A920-263	91	31-6A226	45	33-14075	40	33-37043-32X	171	33-64176-C-K07	46
31-3A921	91	31-6A310-972	52	33-14076	40	33-37046-22X	171	33-64182-C-K14	46
31-3A929	91	31-6A310-C-972	52	33-14109	128	33-37047-42X	171	33-64183-C-K14	46
31-3AB26	52	31-6A320-972	53	33-14142	40	33-37072-12X	171	33-64187-C-K14	46
31-3AC26	52	31-6A320-C-972	53	33-14143	40	33-37076-22X	171	33-64209	128
31-3AM26	90	31-6A583	52	33-14147	40	33-37142-12X	171	33-64232-C-K16	46
31-3AN26	52	31-6AB26	52	33-14158-S69	128	33-37143-32X	171	33-64233-C-K16	46
31-3AR26	52	31-6AC26	52	33-14162	40	33-37146-22X	171	33-64235-C-K16	46
31-64172-K07	102	31-6AM26	90	33-14163	40	33-37147-42X	171	33-64237-C-K16	46
31-64173-K07	102	31-6AN26	52	33-14165	40	33-37162-12X	171	33-64242-C-K04	46
31-64175-K07	102	31-6AR26	52	33-14167	40	33-37163-32X	171	33-64243-C-K04	46
31-64176-K07	102	31-94172-K07	104	33-14209	128	33-37166-22X	171	33-64245-C-K04	46
31-64187-K14	102	31-94173-K07	104	33-18042	40	33-37167-42X	171	33-64247-C-K04	46
31-64232-K16	102	31-94175-K07	104	33-18043	40	33-38042	42	33-67042-12X	171
31-64233-K16	102	31-94176-K07	104	33-18045	40	33-38043	42	33-67043-32X	171
31-64235-K16	102	31-94182-K14	104	33-18047	40	33-38045	42	33-67046-22X	171
31-64237-K16	102	31-94183-K14	104	33-18072	40	33-38047	42	33-67047-42X	171
31-64242-K04	102	31-94187-K14	104	33-18073	40	33-38058-S82	128	33-67072-12X	171
31-64243-K04	102	31-94232-K16	104	33-18075	40	33-38072	42	33-67076-22X	171
31-64245-K04	102	31-94233-K16	104	33-18076	40	33-38075	42	33-67143-32X	171
31-64247-K04	102	31-94235-K16	104	33-18109	128	33-38076	42	33-67146-22X	171
31-68172-K07	102	31-94237-K16	104	33-18142	40	33-38142	42	33-67147-42X	171
31-68173-K07	102	31-94242-K04	104	33-18143	40	33-38143	42	33-67162-12X	171
31-68175-K07	102	31-94243-K04	104	33-18147	40	33-38147	42	33-67163-32X	171
31-68176-K07	102	31-94245-K04	104	33-18162	40	33-38162	42	33-67166-22X	171
31-68182-K14	102	31-94247-K04	104	33-18163	40	33-38163	42	33-67167-42X	171
31-68182-K14	102	31-98172-K07	104	33-18165	40	33-38165	42	33-67173-C-K07-LG8	169
31-68183-K14	102	31-98173-K07	104	33-18167	40	33-38167	42	33-67175-C-K16-LG8	169
31-68183-K14	102	31-98175-K07	104	33-31***-MTR	181	33-38209	128	33-67183-C-K14-LG8	169
31-68187-K14	102	31-98176-K07	104	33-34042	42	33-38531	86	33-67233-C-K16-LG8	169
31-68232-K16	102	31-98182-K14	104	33-34043	42	33-38540	86	33-67243-C-K04-LG8	169
31-68233-K16	102	31-98184-K14	104	33-34045	42	33-38541	86	33-6742-12X	171
31-68235-K16	102	31-98187-K14	104	33-34047	42	33-38550	86	33-68042	44

PARTS INDEX

Part number	Pg	Part number	Pg	Part number	Pg	Part number	Pg	Part number	Pg
33-68043	44	33-97147-42X	171	35-18047-xxx-HAZ	204	35-34209-xxx-HAZ	224	35-64209-xxx-HAZ	224
33-68045	44	33-97162-12X	171	35-18072-xxx-HAZ	204	35-34232-K16-xxx-HAZ	218	35-64232-C-K16-xxx-HAZ	210
33-68047	44	33-97163-32X	171	35-18073-xxx-HAZ	204	35-34233-K16-xxx-HAZ	218	35-64232-K16-xxx-HAZ	220
33-68058-S82	128	33-97166-22X	171	35-18075-xxx-HAZ	204	35-34235-K16-xxx-HAZ	218	35-64233-K16-xxx-HAZ	220
33-68072	44	33-97167-42X	171	35-18076-xxx-HAZ	204	35-34237-K16-xxx-HAZ	218	35-64235-C-K16-xxx-HAZ	210
33-68075	44	33-98042	48	35-18109-xxx-HAZ	224	35-34242-K04-xxx-HAZ	218	35-64235-C-K16-xxx-HAZ	210
33-68076	44	33-98043	48	35-18142-xxx-HAZ	204	35-34243-K04-xxx-HAZ	218	35-64235-K16-xxx-HAZ	220
33-68142	44	33-98045	48	35-18143-xxx-HAZ	204	35-34245-K04-xxx-HAZ	218	35-64237-C-K16-xxx-HAZ	210
33-68143	44	33-98047	48	35-18147-xxx-HAZ	204	35-34247-K04-xxx-HAZ	218	35-64237-K16-xxx-HAZ	220
33-68147	44	33-98058-S82	128	35-18162-xxx-HAZ	204	35-38042-xxx-HAZ	206	35-64242-C-K04-xxx-HAZ	210
33-68162	44	33-98072	48	35-18163-xxx-HAZ	204	35-38043-xxx-HAZ	206	35-64242-K04-xxx-HAZ	220
33-68163	44	33-98075	48	35-18165-xxx-HAZ	204	35-38045-xxx-HAZ	206	35-64243-C-K04-xxx-HAZ	210
33-68165	44	33-98076	48	35-18167-xxx-HAZ	204	35-38047-xxx-HAZ	206	35-64243-K04-xxx-HAZ	220
33-68167	44	33-98142	48	35-18172-K07-xxx-HAZ	216	35-38072-xxx-HAZ	206	35-64245-C-K04-xxx-HAZ	210
33-68172-C-K07	46	33-98143	48	35-18173-K07-xxx-HAZ	216	35-38073-xxx-HAZ	206	35-64245-K04-xxx-HAZ	220
33-68175-C-K07	46	33-98147	48	35-18175-K07-xxx-HAZ	216	35-38075-xxx-HAZ	206	35-64247-C-K04-xxx-HAZ	210
33-68176-C-K07	46	33-98162	48	35-18176-K07-xxx-HAZ	216	35-38076-xxx-HAZ	206	35-64247-K04-xxx-HAZ	220
33-68182-C-K14	46	33-98163	48	35-18182-K14-xxx-HAZ	216	35-38109-xxx-HAZ	224	35-68109-xxx-HAZ	224
33-68183-C-K14	46	33-98165	48	35-18183-K14-xxx-HAZ	216	35-38142-xxx-HAZ	206	35-68172-C-K07-xxx-HAZ	210
33-68187-C-K14	46	33-98167	48	35-18187-K14-xxx-HAZ	216	35-38143-xxx-HAZ	206	35-68172-K07-xxx-HAZ	220
33-68209	128	33-98209	128	35-18209-xxx-HAZ	224	35-38147-xxx-HAZ	206	35-68173-C-K07-xxx-HAZ	210
33-68232-C-K16	46	35-14042-xxx-HAZ	204	35-18232-K16-xxx-HAZ	216	35-38162-xxx-HAZ	206	35-68173-K07-xxx-HAZ	220
33-68233-C-K16	46	35-14043-xxx-HAZ	204	35-18233-K16-xxx-HAZ	216	35-38163-xxx-HAZ	206	35-68175-C-K07-xxx-HAZ	210
33-68235-C-K16	46	35-14045-xxx-HAZ	204	35-18235-K16-xxx-HAZ	216	35-38165-xxx-HAZ	206	35-68175-K07-xxx-HAZ	220
33-68237-C-K16	46	35-14047-xxx-HAZ	204	35-18237-K16-xxx-HAZ	216	35-38167-xxx-HAZ	206	35-68176-C-K07-xxx-HAZ	210
33-68242-C-K04	46	35-14072-xxx-HAZ	204	35-18242-K04-xxx-HAZ	216	35-38172-K07-xxx-HAZ	218	35-68176-K07-xxx-HAZ	220
33-68243-C-K04	46	35-14073-xxx-HAZ	204	35-18243-K04-xxx-HAZ	216	35-38173-K07-xxx-HAZ	218	35-68182-C-K14-xxx-HAZ	210
33-68245-C-K04	46	35-14075-xxx-HAZ	204	35-18245-K04-xxx-HAZ	216	35-38175-K07-xxx-HAZ	218	35-68182-K14-xxx-HAZ	220
33-68247-C-K04	46	35-14076-xxx-HAZ	204	35-18247-K04-xxx-HAZ	216	35-38176-K07-xxx-HAZ	218	35-68183-C-K14-xxx-HAZ	210
33-91***-MTR	181	35-14109-xxx-HAZ	224	35-34042-xxx-HAZ	206	35-38182-K14-xxx-HAZ	218	35-68183-K14-xxx-HAZ	220
33-94042	48	35-14142-xxx-HAZ	204	35-34043-xxx-HAZ	206	35-38183-K14-xxx-HAZ	218	35-68187-C-K14-xxx-HAZ	210
33-94043	48	35-14143-xxx-HAZ	204	35-34045-xxx-HAZ	206	35-38187-K14-xxx-HAZ	218	35-68187-K14-xxx-HAZ	220
33-94045	48	35-14147-xxx-HAZ	204	35-34047-xxx-HAZ	206	35-38209-xxx-HAZ	224	35-68209-xxx-HAZ	224
33-94047	48	35-14162-xxx-HAZ	204	35-34072-xxx-HAZ	206	35-38232-K16-xxx-HAZ	218	35-68232-C-K16-xxx-HAZ	210
33-94058-S82	128	35-14163-xxx-HAZ	204	35-34073-xxx-HAZ	206	35-38233-K16-xxx-HAZ	218	35-68232-K16-xxx-HAZ	220
33-94072	48	35-14165-xxx-HAZ	204	35-34075-xxx-HAZ	206	35-38235-K16-xxx-HAZ	218	35-68233-K16-xxx-HAZ	220
33-94075	48	35-14167-xxx-HAZ	204	35-34076-xxx-HAZ	206	35-38237-K16-xxx-HAZ	218	35-68235-C-K16-xxx-HAZ	210
33-94076	48	35-14172-K07-xxx-HAZ	216	35-34109-xxx-HAZ	224	35-38242-K04-xxx-HAZ	218	35-68235-C-K16-xxx-HAZ	210
33-94109	128	35-14173-K07-xxx-HAZ	216	35-34142-xxx-HAZ	206	35-38243-K04-xxx-HAZ	218	35-68235-K16-xxx-HAZ	220
33-94142	48	35-14175-K07-xxx-HAZ	216	35-34143-xxx-HAZ	206	35-38245-K04-xxx-HAZ	218	35-68237-C-K16-xxx-HAZ	210
33-94143	48	35-14176-K07-xxx-HAZ	216	35-34147-xxx-HAZ	206	35-38247-K04-xxx-HAZ	218	35-68237-K16-xxx-HAZ	220
33-94147	48	35-14182-K14-xxx-HAZ	216	35-34162-xxx-HAZ	206	35-64109-xxx-HAZ	224	35-68242-C-K04-xxx-HAZ	210
33-94162	48	35-14183-K14-xxx-HAZ	216	35-34163-xxx-HAZ	206	35-64172-C-K07-xxx-HAZ	210	35-68242-K04-xxx-HAZ	220
33-94163	48	35-14187-K14-xxx-HAZ	216	35-34165-xxx-HAZ	206	35-64172-K07-xxx-HAZ	220	35-68243-C-K04-xxx-HAZ	210
33-94165	48	35-14209-xxx-HAZ	224	35-34167-xxx-HAZ	206	35-64173-C-K07-xxx-HAZ	210	35-68243-K04-xxx-HAZ	220
33-94167	48	35-14232-K16-xxx-HAZ	216	35-34172-K07-xxx-HAZ	218	35-64173-K07-xxx-HAZ	220	35-68245-C-K04-xxx-HAZ	210
33-94209	128	35-14233-K16-xxx-HAZ	216	35-34173-K07-xxx-HAZ	218	35-64175-C-K07-xxx-HAZ	210	35-68245-K04-xxx-HAZ	220
33-97042-12X	171	35-14235-K16-xxx-HAZ	216	35-34175-K07-xxx-HAZ	218	35-64175-K07-xxx-HAZ	220	35-68247-C-K04-xxx-HAZ	210
33-97043-32X	171	35-14237-K16-xxx-HAZ	216	35-34176-K07-xxx-HAZ	218	35-64176-C-K07-xxx-HAZ	210	35-68247-K04-xxx-HAZ	220
33-97046-22X	171	35-14242-K04-xxx-HAZ	216	35-34176-K07-xxx-HAZ	218	35-64176-K07-xxx-HAZ	220	35-9A126	49
33-97047-42X	171	35-14243-K04-xxx-HAZ	216	35-34176-K07-xxx-HAZ	218	35-64182-C-K14-xxx-HAZ	210	36-24022-K14-xxx-HAZ	222
33-97072-12X	171	35-14245-K04-xxx-HAZ	216	35-34182-K14-xxx-HAZ	218	35-64182-K14-xxx-HAZ	220	36-24023-K14-xxx-HAZ	222
33-97076-22X	171	35-18042-xxx-HAZ	204	35-34182-K14-xxx-HAZ	218	35-64183-C-K14-xxx-HAZ	210	36-24027-K14-xxx-HAZ	222
33-97142-12X	171	35-18043-xxx-HAZ	204	35-34183-K14-xxx-HAZ	218	35-64183-K14-xxx-HAZ	220	36-24032-K07-xxx-HAZ	222
33-97143-32X	171	35-18045-xxx-HAZ	204	35-34187-K14-xxx-HAZ	218	35-64187-C-K14-xxx-HAZ	210	36-24033-K07-xxx-HAZ	222
33-97146-22X	171			35-34187-K14-xxx-HAZ	218	35-64187-K14-xxx-HAZ	220	36-24035-K07-xxx-HAZ	222

Part number	Pg	Part number	Pg	Part number	Pg	Part number	Pg	Part number	Pg
36-24036-K07-xxx-HAZ	222	36-28245-K04-xxx-HAZ	222	36-68076-xxx-HAZ	208	36-D0002-32M	241	37-38551	86
36-24042-xxx-HAZ	214	36-28247-K04-xxx-HAZ	222	36-68109-xxx-HAZ	224	36-D1002	241	37-38560	86
36-24043-xxx-HAZ	214	36-64042-xxx-HAZ	208	36-68142-xxx-HAZ	208	36-D1002-32M	241	37-38561	86
36-24045-xxx-HAZ	214	36-64043-xxx-HAZ	208	36-68143-xxx-HAZ	208	36-D3002	241	37-38570	86
36-24047-xxx-HAZ	214	36-64045-xxx-HAZ	208	36-68147-xxx-HAZ	208	36-D3002-32M	241	37-64042	44
36-24072-xxx-HAZ	214	36-64047-xxx-HAZ	208	36-68162-xxx-HAZ	208	36-D6002	241	37-64043	44
36-24073-xxx-HAZ	214	36-64072-xxx-HAZ	208	36-68163-xxx-HAZ	208	36-D6002-32M	241	37-64045	44
36-24075-xxx-HAZ	214	36-64073-xxx-HAZ	208	36-68165-xxx-HAZ	208	36-D7002	241	37-64047	44
36-24076-xxx-HAZ	214	36-64075-xxx-HAZ	208	36-68167-xxx-HAZ	208	36-D9002	241	37-64058-S82	128
36-24109-xxx-HAZ	224	36-64076-xxx-HAZ	208	36-68172-C-K07-xxx-HAZ	210	37-21***-MTR	181	37-64072	44
36-24142-xxx-HAZ*	214	36-64109-xxx-HAZ	224	36-68172-K07-xxx-HAZ	220	37-24042	50	37-64075	44
36-24143-xxx-HAZ*	214	36-64142-xxx-HAZ	208	36-68173-C-K07-xxx-HAZ	210	37-24043	50	37-64076	44
36-24147-xxx-HAZ*	214	36-64143-xxx-HAZ	208	36-68173-K07-xxx-HAZ	220	37-24045	50	37-64109	128
36-24162-xxx-HAZ	214	36-64147-xxx-HAZ	208	36-68175-C-K07-xxx-HAZ	210	37-24047	50	37-64142	44
36-24163-xxx-HAZ	214	36-64162-xxx-HAZ	208	36-68175-K07-xxx-HAZ	220	37-24072	50	37-64143	44
36-24165-xxx-HAZ	214	36-64163-xxx-HAZ	208	36-68176-C-K07-xxx-HAZ	210	37-24075	50	37-64147	44
36-24167-xxx-HAZ	214	36-64165-xxx-HAZ	208	36-68176-K07-xxx-HAZ	220	37-24076	50	37-64158-S69	128
36-24209-xxx-HAZ	224	36-64167-xxx-HAZ	208	36-68182-C-K14-xxx-HAZ	210	37-24109	128	37-64162	44
36-24232-K16-xxx-HAZ	222	36-64172-C-K07-xxx-HAZ	210	36-68182-K14-xxx-HAZ	220	37-24162	50	37-64163	44
36-24233-K16-xxx-HAZ	222	36-64172-K07-xxx-HAZ	220	36-68183-C-K14-xxx-HAZ	210	37-24163	50	37-64165	44
36-24235-K16-xxx-HAZ	222	36-64173-C-K07-xxx-HAZ	210	36-68183-K14-xxx-HAZ	220	37-24165	50	37-64167	44
36-24237-K16-xxx-HAZ	222	36-64173-K07-xxx-HAZ	220	36-68187-C-K14-xxx-HAZ	210	37-24167	50	37-64175-C-K07	46
36-24242-K04-xxx-HAZ	222	36-64175-C-K07-xxx-HAZ	210	36-68187-K14-xxx-HAZ	220	37-27042-12X	171	37-64176-C-K07	46
36-24243-K04-xxx-HAZ	222	36-64175-K07-xxx-HAZ	220	36-68209-xxx-HAZ	224	37-27043-32X	171	37-64182-C-K14	46
36-24245-K04-xxx-HAZ	222	36-64176-C-K07-xxx-HAZ	210	36-682147	208	37-27046-22X	171	37-64183-C-K14	46
36-24247-K04-xxx-HAZ	222	36-64176-K07-xxx-HAZ	220	36-68232-C-K16-xxx-HAZ	210	37-27047-42X	171	37-64187-C-K14	46
36-28022-K14-xxx-HAZ	222	36-64182-C-K14-xxx-HAZ	210	36-68232-K16-xxx-HAZ	220	37-27072-12X	171	37-64209	128
36-28023-K14-xxx-HAZ	222	36-64182-K14-xxx-HAZ	220	36-68233-C-K16-xxx-HAZ	210	37-27076-22X	171	37-64232-C-K16	46
36-28027-K14-xxx-HAZ	222	36-64183-C-K14-xxx-HAZ	210	36-68233-K16-xxx-HAZ	220	37-27162-12X	171	37-64233-C-K16	46
36-28032-K07-xxx-HAZ	222	36-64183-K14-xxx-HAZ	220	36-68235-C-K16-xxx-HAZ	210	37-27163-32X	171	37-64237-C-K16	46
36-28033-K07-xxx-HAZ	222	36-64187-C-K14-xxx-HAZ	210	36-68235-K16-xxx-HAZ	220	37-27166-22X	171	37-64242-C-K04	46
36-28035-K07-xxx-HAZ	222	36-64187-K14-xxx-HAZ	220	36-68236-C-K16-xxx-HAZ	210	37-27167-42X	171	37-64243-C-K04	46
36-28036-K07-xxx-HAZ	222	36-64209-xxx-HAZ	224	36-68237-K16-xxx-HAZ	220	37-28042	50	37-64245-C-K04	46
36-28042-xxx-HAZ	214	36-64232-C-K16-xxx-HAZ	210	36-68242-C-K04-xxx-HAZ	210	37-28043	50	37-64247-C-K04	46
36-28043-xxx-HAZ	214	36-64232-K16-xxx-HAZ	220	36-68242-K04-xxx-HAZ	220	37-28045	50	37-67042-12X	171
36-28045-xxx-HAZ	214	36-64233-C-K16-xxx-HAZ	210	36-68243-C-K04-xxx-HAZ	210	37-28047	50	37-67043-32X	171
36-28047-xxx-HAZ	214	36-64233-K16-xxx-HAZ	220	36-68243-K04-xxx-HAZ	220	37-28072	50	37-67046-22X	171
36-28072-xxx-HAZ	214	36-64235-C-K16-xxx-HAZ	210	36-68245-C-K04-xxx-HAZ	210	37-28075	50	37-67047-42X	171
36-28073-xxx-HAZ	214	36-64235-K16-xxx-HAZ	220	36-68245-K04-xxx-HAZ	220	37-28076	50	37-67072-12X	171
36-28075-xxx-HAZ	214	36-64236-C-K16-xxx-HAZ	210	36-68247-C-K04-xxx-HAZ	210	37-28162	50	37-67076-22X	171
36-28076-xxx-HAZ	214	36-64237-K16-xxx-HAZ	220	36-68247-K04-xxx-HAZ	220	37-28163	50	37-67144-42X	171
36-28109-xxx-HAZ	224	36-64242-C-K04-xxx-HAZ	210	36-94109-xxx-HAZ	224	37-28165	50	37-67146-22X	171
36-28142-xxx-HAZ*	214	36-64242-K04-xxx-HAZ	220	36-94209-xxx-HAZ	224	37-28167	50	37-67162-12X	171
36-28143-xxx-HAZ*	214	36-64243-C-K04-xxx-HAZ	210	36-98109-xxx-HAZ	224	37-28209	128	37-67163-32X	171
36-28147-xxx-HAZ*	214	36-64243-K04-xxx-HAZ	220	36-98209-xxx-HAZ	224	37-34531	86	37-67166-22X	171
36-28162-xxx-HAZ	214	36-64245-C-K04-xxx-HAZ	210	36-C0003	241	37-34540	86	37-67167-42X	171
36-28163-xxx-HAZ	214	36-64245-K04-xxx-HAZ	220	36-C0003-32M	241	37-34541	86	37-67173-C-K07-LG8	169
36-28165-xxx-HAZ	214	36-64247-C-K04-xxx-HAZ	210	36-C1003	241	37-34550	86	37-67175-C-K16-LG8	169
36-28167-xxx-HAZ	214	36-64247-K04-xxx-HAZ	220	36-C1003-32M	241	37-34551	86	37-67233-C-K16-LG8	169
36-28209-xxx-HAZ	224	36-68042-xxx-HAZ	208	36-C3003	241	37-34560	86	37-67243-C-K04-LG8	169
36-28232-K16-xxx-HAZ	222	36-68043-xxx-HAZ	208	36-C3003-32M	241	37-34561	86	37-67442-12X	171
36-28233-K16-xxx-HAZ	222	36-68045-xxx-HAZ	208	36-C6003	241	37-34570	86	37-67443-32X	171
36-28235-K16-xxx-HAZ	222	36-68047-xxx-HAZ	208	36-C6003-32M	241	37-38531	86	37-68042	44
36-28237-K16-xxx-HAZ	222	36-68072-xxx-HAZ	208	36-C7003	241	37-38540	86	37-68043	44
36-28242-K04-xxx-HAZ	222	36-68073-xxx-HAZ	208	36-C9003	241	37-38541	86	37-68045	44
36-28243-K04-xxx-HAZ	222	36-68075-xxx-HAZ	208	36-D0002	241	37-38550	86	37-68047	44

PARTS INDEX

Part number	Pg	Part number	Pg	Part number	Pg	Part number	Pg	Part number	Pg
37-68058-S82	128	37-97166-22X	171	39-2A011-A06	110	39-4A021-A06	111	39-98172-K07	104
37-68072	44	37-97167-42X	171	39-2A014	52	39-4A024	111	39-98173-K07	104
37-68075	44	37-98042	48	39-2A019-A06	110	39-4A029	111	39-98175-K07	104
37-68076	44	37-98043	48	39-2A020	53	39-4A310-172	110	39-98176-K07	104
37-68142	44	37-98045	48	39-2A020-A06	111	39-4A320-172	111	39-98182-K14	104
37-68143	44	37-98047	48	39-2A020-B	53	39-4A583	111	39-98183-K14	104
37-68147	44	37-98072	48	39-2A020-T	53	39-64172-K07	102	39-98187-K14	104
37-68162	44	37-98075	48	39-2A021	53	39-64173-K07	102	39-98232-K16	104
37-68163	44	37-98076	48	39-2A021-A06	111	39-64175-K07	102	39-98233-K16	104
37-68165	44	37-98142	48	39-2A024	53	39-64176-K07	102	39-98235-K16	104
37-68167	44	37-98143	48	39-2A029-A06	111	39-64182-K14	102	39-98237-K16	104
37-68172-C-K07	46	37-98147	48	39-2A056	52	39-64183-K14	102	39-98242-K04	104
37-68175-C-K07	46	37-98162	48	39-2A110	52	39-64232-K16	102	39-98243-K04	104
37-68176-C-K07	46	37-98163	48	39-2A110-A06	110	39-64233-K16	102	39-98245-K04	104
37-68182-C-K14	46	37-98165	48	39-2A220	53	39-64235-K16	102	39-98247-K04	104
37-68183-CK14	46	37-98209	128	39-2A220-A06	111	39-64237-K16	102	39-9A014	52
37-68187-C-K14	46	37-B4002-SS	78	39-2A310-172	52	39-64242-K04	102	39-9A024	53
37-68209	128	37-B8002-SS	78	39-2A310-172-A06	110	39-64243-K04	102	39-9A583	52
37-68232-C-K16	46	37-C4003-SS	80	39-2A320-172	53	39-64245-K04	102	39-9A824	53
37-68233-C-K16	46	37-C8003-SS	80	39-2A320-172-A06	111	39-64247-K04	102	39-9A925	34
37-68235-C-K16	46	39-1A824	53	39-2A583	52	39-68172-K07	102	4-0201-*	174
37-68237-C-K16	46	39-24022-K14	106	39-2AB26	52	39-68173-K07	102	4-0301-*	174
37-68242-C-K04	46	39-24023-K14	106	39-2AC26	52	39-68175-K07	102	4-2301-*	174
37-68243-C-K04	46	39-24027-K14	106	39-2AN26	52	39-68176-K07	102	4-2401-*	174
37-68245-C-K04	46	39-24032-K07	106	39-2AR26	52	39-68182-K14	102	4-2901-*	174
37-68247-C-K04	46	39-24033-K07	106	39-34931	88	39-68183-K14	102	4-3301-*	174
37-68258-S69	128	39-24035-K07	106	39-34940	88	39-68232-K16	102	4-3401-*	174
37-94042	48	39-24036-K07	106	39-34941	88	39-68233-K16	102	4-3901-*	174
37-94043	48	39-24232-K16	106	39-34950	88	39-68235-K16	102	42-41001-32P	244
37-94045	48	39-24233-K16	106	39-34951	88	39-68237-K16	102	42-41001-40P	244
37-94047	48	39-24235-K16	106	39-34960	88	39-68242-K04	102	42-41001-50P	244
37-94072	48	39-24237-K16	106	39-34961	88	39-68243-K04	102	42-41001-63P	244
37-94075	48	39-24242-K04	106	39-34970	88	39-68245-K04	102	42-41002-32P	244
37-94076	48	39-24243-K04	106	39-38931	88	39-68247-K04	102	42-41002-40P	244
37-94109	128	39-24245-K04	106	39-38940	88	39-6A014	52	42-41002-50P	244
37-94142	48	39-24247-K04	106	39-38941	88	39-6A024	53	42-41002-63P	244
37-94143	48	39-28022-K14	106	39-38950	88	39-6A110	52	42-41003-32P	244
37-94147	48	39-28023-K14	106	39-38951	88	39-6A220	53	42-41003-40P	244
37-94162	48	39-28027-K07	106	39-38960	88	39-6A220-C	53	42-41003-50P	244
37-94163	48	39-28032-K07	106	39-38961	88	39-6A583	53	42-41003-63P	244
37-94165	48	39-28033-K07	106	39-38970	88	39-6A824	53	42-4100M-32P	244
37-94167	48	39-28035-K07	106	39-44043-172	108	39-94172-K07	104	42-4100M-40P	244
37-94209	128	39-28036-K07	106	39-44073-172	108	39-94173-K07	104	42-4100M-50P	244
37-97042-12X	171	39-28232-K16	106	39-44143-172	108	39-94175-K07	104	42-4100M-63P	244
37-97043-32X	171	39-28233-K16	106	39-44163-172	108	39-94176-K07	104	42-4100N-32P	244
37-97046-22X	171	39-28235-K16	106	39-48043-172	108	39-94182-K14	104	42-4100N-40P	244
37-97047-42X	171	39-28237-K16	106	39-48073-172	108	39-94183-K14	104	42-4100N-50P	244
37-97072-12X	171	39-28242-K04	106	39-48143-172	108	39-94187-K14	104	42-4100N-63P	244
37-97076-22X	171	39-28243-K04	106	39-48163-172	108	39-94232-K16	104	42-4100P-32P	244
37-97142-12X	171	39-28245-K04	106	39-4A010-B	110	39-94233-K16	104	42-4100P-40P	244
37-97143-32X	171	39-28247-K04	106	39-4A010-T	110	39-94235-K16	104	42-4100P-50P	244
37-97146-22X	171	39-2A010	52	39-4A011-A06	110	39-94237-K16	104	42-4100P-63P	244
37-97147-42X	171	39-2A010-A06	110	39-4A014	110	39-94242-K04	104	42-4100T-32P	244
37-97162-12X	171	39-2A010-B	52	39-4A019	110	39-94243-K04	104	42-4100T-40P	244
37-97163-32X	171	39-2A010-T	52	39-4A020-B	111	39-94245-K04	104	42-4100T-50P	244
37-97165-22X	171	39-2A011	52	39-4A020-T	111	39-94247-K04	104	42-4100T-63P	244

Part number	Pg	Part number	Pg	Part number	Pg	Part number	Pg	Part number	Pg
42-47001	244	45-44003-P80	146	47-38145	134	49-44146	134	49-6A029	138
42-47002	244	45-4400M	146	47-38146	134	49-44147	134	49-6A126	135
42-47003	244	45-4400N	146	47-38147	134	49-48042	134	49-6A913-XXX	135
42-4700M	244	45-4400N-P80	146	47-3A010	138	49-48043	134	49-6A925	135
42-4700N	244	45-4400P	146	47-3A011	138	49-48045	134	4CN30	81
42-4700P	244	45-4400T	146	47-3A011N	138	49-48046	134	511B0N05	75
42-4700T	244	45-4400T-P80	146	47-3A013-XXX	130	49-48047	134	511B0N07	75
45-34001	150	45-48001	146	47-3A014	138	49-48142	134	511B3N05	27
45-34001-P80	150	45-48001-P80	146	47-3A019	138	49-48143	134	511B3N07	27
45-34002	150	45-48002	146	47-3A020	138	49-48145	134	511C7000	27
45-34002-P80	150	45-48002-P80	146	47-3A021	138	49-48146	134	511M3	27
45-34003	150	45-48003	146	47-3A021N	138	49-48147	134	511POD18	27
45-34003-P80	150	45-48003-P80	146	47-3A024	138	49-4A010	138	511POD21	27
45-3400M	150	45-4800M	146	47-3A029	138	49-4A011	138	511PON05	27
45-3400M-P80	150	45-4800N	146	47-3A126	135	49-4A011N	138	511PON07	27
45-3400N	150	45-4800N-P80	146	47-3A913-XXX	135	49-4A013-XXX	135	511PON10	27
45-3400N-P80	150	45-4800P	146	47-3A925	135	49-4A014	138	511P6D18	27
45-3400P	150	45-4800T	146	49-34042	134	49-4A019	138	512B3N05	29
45-3400P-P80	150	45-4800T-P80	146	49-34043	134	49-4A020	138	512B3N07	29
45-3400T	150	45-4A027	147	49-34045	134	49-4A021	138	512C7000	29
45-3400T-P80	150	45-4A12C	147	49-34046	134	49-4A021N	138	512M3	29
45-38001	150	45-4A12D	151	49-34047	134	49-4A024	138	512POD21	29
45-38001-P80	150	45-4A15C	147	49-34142	134	49-4A029	138	512PON05	29
45-38002	150	45-4A15D	147	49-34143	134	49-4A126	135	512PON07	29
45-38002-P80	150	45-4A18C	147	49-34145	134	49-4A913-XXX	135	512PON10	29
45-38003	150	45-4A18D	147	49-34146	134	49-4A925	135	512PON12	29
45-38003-P80	150	45-4A24C	147	49-34147	134	49-64042	134	513B3N05	31
45-3800M	150	45-4A24D	147	49-38042	134	49-64043	134	513B3N07	31
45-3800M-P80	150	45-4A30C	147	49-38043	134	49-64045	134	513B3N10	31
45-3800N	150	45-4A30D	147	49-38045	134	49-64046	134	513C7000	31
45-3800N-P80	150	45-4A40C	147	49-38046	134	49-64047	134	513M3	31
45-3800P	150	45-4A40D	147	49-38047	134	49-64142	134	513POD30	31
45-3800P-P80	150	45-4A50C	147	49-38142	134	49-64143	134	513POD30473	31
45-3800T	150	45-4A50D	147	49-38143	134	49-64145	134	513PON05	31
45-3800T-P80	150	45-4A70C	147	49-38145	134	49-64146	134	513PON07	31
45-3A027	150	45-4A70D	147	49-38146	134	49-64147	134	513PON10	31
45-3A126	150	45-4A753*	147	49-38147	134	49-68042	134	513PON12	31
45-3A396	150	45-4A95C	147	49-3A011	138	49-68043	134	514B3N05	45
45-3A540	150	45-4A95D	147	49-3A013-XXX	135	49-68045	134	514B3N07	45
45-3A753	151	47-34042	134	49-3A014	138	49-68046	134	514B3N10	45
45-3A753-A	151	47-34043	134	49-3A020	138	49-68047	134	514B3N12	45
45-3A753-B	151	47-34045	134	49-3A021	138	49-68142	134	514C7000	45
45-3A753-C	151	47-34046	134	49-3A021N	138	49-68143	134	514M3	45
45-3A753-D	151	47-34047	134	49-3A024	138	49-68145	134	514POD35	45
45-3A753-E	151	47-34142	134	49-3A029	138	49-68146	134	514POD35473	45
45-3A783	151	47-34143	134	49-3A126	135	49-68147	134	514PON05	45
45-3A783-A	151	47-34145	134	49-3A913-XXX	135	49-6A010	138	514PON07	45
45-3A783-B	151	47-34146	134	49-3A925	135	49-6A011	138	514PON10	45
45-3A783-C	151	47-34147	134	49-44042	134	49-6A011N	138	514PON12	45
45-3A783-D	151	47-38042	134	49-44043	134	49-6A013-XXX	135	514PON15	45
45-3A843	150	47-38043	134	49-44045	134	49-6A014	138	515M3	33
45-44001	146	47-38045	134	49-44046	134	49-6A019	138	515PON07	33
45-44001-P80	146	47-38046	134	49-44047	134	49-6A020	138	515PON10	33
45-44002	146	47-38047	134	49-44142	134	49-6A021	138	515PON12	33
45-44002-P80	146	47-38142	134	49-44143	134	49-6A021N	138	515PON15	33
45-44003	146	47-38143	134	49-44145	134	49-6A024	138	515PON20	33

PARTS INDEX

Part number	Pg	Part number	Pg	Part number	Pg	Part number	Pg	Part number	Pg
516P0N15	51	554P0N10	225	594M7	45	5K5P0N10	213	61-3AN26	34
516P0N20	51	554P0N12	209	594P0N05	45	5K5P0N12	213	61-3AR26	34
516P0N25	51	554P0N12	211	594P0N07	45	5K5P0N15	213	61-6A010	34
552M3	205	554P0N12	221	594P0N10	45	5K5P0N20	213	61-6A010-B	34
552M3	217	554P0N12	225	594P0N12	45	5K6M0	215	61-6A010-T	34
552M3	225	554P0N15	209	594P0N15	45	5K6M6	215	61-6A014	34
552P0D21	205	554P0N15	211	595M0	33	5K6P0N10	215	61-6A020	35
552P0D21	217	554P0N15	221	595M3	33	5K6P0N12	215	61-6A020-B	35
552P0D21	225	554P0N15	225	595M7	33	5K6P0N15	215	61-6A020-T	35
552P0N05	205	555P0D25	33	595P0N07	33	5K6P0N20	215	61-6A024	35
552P0N05	217	555P0D25	213	595P0N10	33	5K6P0N25	215	61-6A426	31
552P0N05	225	555P0D35	33	595P0N12	33	5K6P0N30	215	61-6A824	35
552P0N07	205	555P0D35	213	595P0N15	33	5T7M0	109	61-6A826	31
552P0N07	217	555P0D45	33	595P0N20	33	5T7M0-115	109	61-9A010	52
552P0N07	225	555P0D45	213	596M0	51	5T7M0-68	109	61-9A010-T	52
552P0N10	205	556P0D35	51	596M6	51	5T7M6	109	61-9A011	52
552P0N10	217	556P0D35	215	596P0N10	51	5T7P0D57	109	61-9A014	52
552P0N10	225	556P0D35	223	596P0N12	51	5T7P0D62	109	61-9A019	52
552P0N12	205	556P0D45	51	596P0N15	51	5T7P0D68	109	61-9A020	53
552P0N12	217	556P0D45	215	596P0N20	51	5T7P0D73	109	61-9A020-T	53
552P0N12	225	556P0D45	223	596P0N25	51	5T7P0N20	109	61-9A021	53
553M3	207	556P0D49	51	596P0N30	51	5T7P0N25	109	61-9A024	53
553M3	219	556P0D49	215	597P0N12	107	5T7P0N30	109	61-9A029	53
553M3	225	556P0D49	223	597P0N15	51	61-1A010	34	61-9A310-262	52
553P0D30	225	571B0N05185	125	597P0N20	51	61-1A010-B	34	61-9A320-262	53
553P0N05	207	571B0N07185	125	597P0N25	51	61-1A010-T	34	61-9A551	52
553P0N05	219	571M0	125	597P0N30	51	61-1A011	34	61-9A552	53
553P0N05	225	571M4185	125	5K2M0	205	61-1A014	34	61-9A824	111
553P0N07	207	571P020M185	125	5K2M3	205	61-1A020	35	61-BA113	90
553P0N07	219	571P025M185	125	5K2P0N05	205	61-1A020-B	35	61-BA213	91
553P0N07	225	571P032M185	125	5K2P0N07	205	61-1A020-T	35	61-BA910	90
553P0N10	207	571P0N05185	125	5K2P0N10	205	61-1A021	35	61-BA920	91
553P0N10	219	571P0N07185	125	5K2P0N12	225	61-1A024	35	61-CA113	90
553P0N10	225	571P0N10185	125	5K3M0	207	61-1A346	27	61-CA500	72
553P0N12	207	591B0N05	75	5K3M3	207	61-1A426	27	61-CA593	72
553P0N12	219	591B0N07	75	5K3M7	207	61-1A583	34	61-CA910	90
553P0N12	225	591M0	27	5K3P0N05	207	61-1A824	35	61-CA920	91
554M3	209	591M4	27	5K3P0N07	207	61-1A826	27	63-11***-MTR	181
554M3	211	591P0N05	75	5K3P0N10	207	61-1AB26	35	63-14042	26
554M3	221	591P0N07	75	5K3P0N12	207	61-1AC26	35	63-14043	26
554M3	225	591P0N10	75	5K4M0	209	61-1AM26	90	63-14045	26
554P0D35	209	592M0	29	5K4M3	209	61-1AR26	34	63-14047	26
554P0D35	211	592M3	29	5K4M7	209	61-3A010	34	63-14072	26
554P0D35	221	592P0N05	29	5K4P0N05	209	61-3A010-B	34	63-14073	26
554P0D35	225	592P0N07	29	5K4P0N07	209	61-3A010-T	34	63-14075	26
554P0N05	209	592P0N10	29	5K4P0N10	209	61-3A014	34	63-14076	26
554P0N05	211	593M0	31	5K4P0N12	209	61-3A020	35	63-14162	26
554P0N05	221	593M3	31	5K4P0N12	209	61-3A020-B	35	63-14163	26
554P0N05	225	593M7	31	5K4P0N12	211	61-3A020-T	35	63-14165	26
554P0N07	209	593P0N05	31	5K4P0N12	221	61-3A024	35	63-14167	26
554P0N07	211	593P0N07	31	5K4P0N12	225	61-3A105	90	63-17043-LG8	169
554P0N07	221	593P0N10	31	5K4P0N15	209	61-3A426	29	63-17073-LG8	169
554P0N07	225	593P0N12	31	5K5M0	213	61-3A826	29	63-17143-LG8	169
554P0N10	209	593P0N15	61	5K5M3	213	61-3AB26	34	63-17163-LG8	169
554P0N10	211	594M0	45	5K5M7	213	61-3AC26	34	63-17165-LG8	169
554P0N10	221	594M3	45	5K5P0N07	213	61-3AM26	90	63-18042	26

Part number	Pg	Part number	Pg	Part number	Pg	Part number	Pg	Part number	Pg
63-18043	26	63-64142	30	63-98167	32	69-94075	32	712P0BP5	41
63-18045	26	63-64143	30	63-9A011	34	69-94076	32	712P0CP4	41
63-18047	26	63-64147	30	63-9A019	34	69-94142	32	712P0DP2	29
63-18072	26	63-64162	30	63-B4002	78	69-94143	32	712P0DP3	29
63-18073	26	63-64163	30	63-B8002	78	69-94147	32	712P0S14	29
63-18075	26	63-64165	30	63-C4003	80	69-94162	32	712P0S16	29
63-18076	26	63-64167	30	63-C8003	80	69-94163	32	712P0S18	29
63-18162	26	63-67043-LG8	169	66-94042	212	69-94167	32	712P0S20	29
63-18163	26	63-67073-LG8	169	66-94042-xxx-HAZ	212	69-98042	32	712P0S22	29
63-18165	26	63-67143-LG8	169	66-94043-xxx-HAZ	212	69-98043	32	713C3N05	31
63-18167	26	63-67163-LG8	169	66-94045-xxx-HAZ	212	69-98045	32	713C3N07	31
63-31***-MTR	181	63-67165-LG8	169	66-94047-xxx-HAZ	212	69-98047	32	713C3N10	31
63-34042	28	63-68042	30	66-94072-xxx-HAZ	212	69-98072	32	713C3N12	31
63-34043	28	63-68043	30	66-94073-xxx-HAZ	212	69-98073	32	713C7N05	31
63-34045	28	63-68045	30	66-94075-xxx-HAZ	212	69-98075	32	713C7N07	31
63-34047	28	63-68047	30	66-94076-xxx-HAZ	212	69-98076	32	713C7N10	31
63-34072	28	63-68072	30	66-94142-xxx-HAZ	212	69-98142	32	713C7N12	31
63-34073	28	63-68073	30	66-94143-xxx-HAZ	212	69-98143	32	713C7N15	31
63-34075	28	63-68075	30	66-94147-xxx-HAZ	212	69-98147	32	713P0CP4	43
63-34076	28	63-68076	30	66-94162-xxx-HAZ	212	69-98162	32	713P0DP2	31
63-34142	28	63-68142	30	66-94163-xxx-HAZ	212	69-98163	32	713P0DP3	31
63-34143	28	63-68143	30	66-94165-xxx-HAZ	212	69-98167	32	713P0EP2	31
63-34147	28	63-68147	30	66-94167-xxx-HAZ	212	69-9A010	52	713P0S14	31
63-34162	28	63-68162	30	66-98042-xxx-HAZ	212	69-9A010-T	52	713P0S16	31
63-34163	28	63-68163	30	66-98043-xxx-HAZ	212	69-9A020	53	713P0S18	31
63-34165	28	63-68163	30	66-98045-xxx-HAZ	212	69-9A020-T	53	713P0S20	31
63-34167	28	63-68167	30	66-98047-xxx-HAZ	212	69-9A029-C	53	713P0S22	31
63-37043-LG8	169	63-94042	32	66-98072-xxx-HAZ	212	69-9A110	52	714C3N10	45
63-37073-LG8	169	63-94043	32	66-98073-xxx-HAZ	212	69-9A220	111	714C3N12	45
63-37143-LG8	169	63-94045	32	66-98075-xxx-HAZ	212	69-9A551	52	714C3N15	45
63-37163-LG8	169	63-94047	32	66-98076-xxx-HAZ	212	69-9A552	111	714C3N20	45
63-37165-LG8	169	63-94072	32	66-98142-xxx-HAZ	212	69-9A924	53	714C7N05	45
63-38042	28	63-94073	32	66-98143-xxx-HAZ	212	711C3N05	27	714C7N07	45
63-38043	28	63-94075	32	66-98147-xxx-HAZ	212	711C3N07	27	714C7N10	45
63-38045	28	63-94076	32	66-98162-xxx-HAZ	212	711C3N10	27	714C7N12	45
63-38047	28	63-94142	32	66-98163-xxx-HAZ	212	711C3N12	27	714C7N15	45
63-38072	28	63-94143	32	66-98165-xxx-HAZ	212	711C7N05	27	714P0DP1	45
63-38073	28	63-94147	32	66-98167-xxx-HAZ	212	711C7N07	27	714P0DP3	45
63-38075	28	63-94162	32	67-9A010	34	711C7N10	27	714P0EP2	45
63-38076	28	63-94163	32	67-9A010-T	34	711C7N12	27	714P0EP3	47
63-38142	28	63-94165	32	67-9A014	34	711C7N15	27	714P0GP2	47
63-38143	28	63-94167	32	67-9A020	35	711P0BP3	27	714P0S22	45
63-38147	28	63-98042	32	67-9A020-T	35	711P0BP4	27	714P0S25	45
63-38162	28	63-98043	32	67-9A024	35	711P0BP5	27	714P0S27	45
63-38163	28	63-98045	32	67-9A551	34	711P0CP4	27	714P0S29	45
63-38165	28	63-98047	32	67-9A552	35	712C3N05	29	715C3N12	33
63-38167	28	63-98072	32	69-1A824	35	712C3N07	29	715C3N15	33
63-61***-MTR	181	63-98073	32	69-64187-K14	102	712C3N10	29	715C3N20	33
63-64042	30	63-98075	32	69-68187-K14	102	712C3N12	29	715C3N25	33
63-64043	30	63-98076	32	69-6A924	35	712C7N05	29	715P0EP3	33
63-64045	30	63-98142	32	69-94042	32	712C7N07	29	715P0GP2	33
63-64047	30	63-98143	32	69-94043	32	712C7N10	29	715P0S22	33
63-64072	30	63-98147	32	69-94045	32	712C7N12	29	715P0S25	33
63-64073	30	63-98162	32	69-94047	32	712C7N15	29	715P0S27	33
63-64075	30	63-98163	32	69-94072	32	712P0BP3	41	715P0S29	33
63-64076	30	63-98165	32	69-94073	32	712P0BP4	41	716P0GP3	51
								751P9N05	75
								751P9N07	75

Part number	Pg	Part number	Pg	Part number	Pg	Part number	Pg	Part number	Pg
751P9N10	75	793C7N12	61	7K3C7N07	207	7X1M4	77	89-3A029	67
752C3N05	205	793M3FS	31	7K3C7N10	207	7X1P0N05	77	89-3A126	61
752C3N07	205	793P0CS4	43	7K4C3N10	209	7X1P0N07	77	89-3A219-172	66
752C3N10	205	793P0DS1	31	7K4C3N12	209	7X1P0N10	77	89-3A229-172	67
752C3N12	205	793P0DS2	31	7K4C3N15	209	7X2C3N10	79	89-3A523	67
752C7N05	205	793P0DS3	31	7K4C3N20	209	7X2M3	79	89-3A925	67
752C7N07	205	793P0ES2	31	7K4C7N10	209	7X2P0N07	79	89-61***-MTR	181
752C7N10	205	794C7N10	63	7K4C7N12	209	7X2P0N10	79	89-64042	62
752C7N12	205	794C7N12	63	7K4C7N15	209	7X3C3N10	81	89-64043	62
752C7N15	205	794C7N15	63	7K4C7N20	209	7X3M3	81	89-64045	62
752C7N15	217	794C7N20	63	7K4F0N10	209	7X3P0N07	81	89-64047	62
752C7N15	225	794M3	45	7K4F0N12	209	7X3P0N10	81	89-64072	62
753C3N05	207	794M3L	45	7K4F0N15	209	7X3P0N12	81	89-64073	62
753C3N07	207	794P0DS2	45	7K4F0N20	209	89-31***-MTR	181	89-64075	62
753C3N10	207	794P0DS3	45	7K4M3L	209	89-34042	60	89-64076	62
753C3N12	207	794P0ES2	45	7K5C3N12	213	89-34043	60	89-64142	62
753C7N05	207	794P0ES4	47	7K5C3N15	213	89-34045	60	89-64143	62
753C7N07	207	794P0FS1	45	7K5C3N20	213	89-34047	60	89-64147	62
753C7N10	207	794P0FS2	47	7K5C3N25	213	89-34072	60	89-64162	62
753C7N12	207	794P0FS3	47	7K5C7N12	213	89-34073	60	89-64163	62
753C7N15	207	795C3N12	33	7K5C7N15	213	89-34075	60	89-64165	62
754C3N10	209	795C3N15	33	7K5C7N20	213	89-34076	60	89-64167	62
754C3N12	221	795C3N20	33	7K5C7N25	213	89-34142	60	89-68042	62
754C3N15	209	795C3N25	33	7K5F0N12	213	89-34143	60	89-68043	62
754C3N20	209	795C7N12	65	7K5F0N15	213	89-34147	60	89-68045	62
771C4N05185	125	795C7N15	65	7K5F0N20	213	89-34162	60	89-68047	62
771C4N07185	125	795C7N20	65	7K5F0N25	213	89-34163	60	89-68072	62
771C4N10185	125	795M3	49	7K5P0N07	213	89-34165	60	89-68073	62
771C4N12185	125	795P0ES4	49	7K5P0N10	213	89-34167	60	89-68075	62
771F0N05	125	795P0FS1	33	7K5P0N12	213	89-38042	60	89-68076	62
771F0N07	125	795P0FS2	33	7K5P0N15	213	89-38043	60	89-68142	62
771F0N10	125	795P0FS3	49	7K5P0N20	213	89-38045	60	89-68143	62
771F0N12	125	795P0N07	33	7K5P0N25	213	89-38047	60	89-68147	62
791C4N05	75	795P0N10	33	7K6C6N15	215	89-38072	60	89-68162	62
791C4N07	75	795P0N12	33	7K6C6N20	215	89-38073	60	89-68163	62
791C4N10	75	795P0N15	33	7K6C6N25	215	89-38075	60	89-68165	62
791C4N12	75	795P0N20	33	7T1F0N05	29	89-38076	60	89-68167	62
791M3FS	75	795P0N25	33	7T1F0N07	29	89-38142	60	89-6A010	66
791P0BS3	75	796C6N15	51	7T1F0N10	29	89-38143	60	89-6A010-172	66
791P0BS3L	27	796C6N20	51	7T1F0N12	29	89-38147	60	89-6A010-B	66
791P0BS4	75	796C6N25	51	7T4F0N10	47	89-38162	60	89-6A010-T	66
791P0BS4L	27	796M4	51	7T4F0N12	47	89-38163	60	89-6A010-T-172	66
791P0BS5	75	796P0GS1	51	7T4F0N15	47	89-38167	60	89-6A011	66
791P0BS5L	27	796P0GS2	51	7T4F0N20	47	89-3A010	66	89-6A014	66
791P0CS4	75	796P0GS3	51	7T5F0N12	33	89-3A010-172	66	89-6A019	66
791P0CS4L	27	796P0GS4	51	7T5F0N15	33	89-3A010-B	66	89-6A020	67
791P0N05L	27	796P0GS5	51	7T5F0N20	33	89-3A010-T	66	89-6A020-172	67
791P0N07L	27	796P0GS6	51	7T5F0N25	33	89-3A010-T-172	66	89-6A020-B	67
791P0N10L	27	796P0KS1	51	7T6F0N15	51	89-3A011	66	89-6A020-T	67
792M3FS	29	796P0KS2	51	7T6F0N20	51	89-3A014	66	89-6A020-T-172	67
792P0CS4	29	7K2C3N05	205	7T6F0N25	51	89-3A019	66	89-6A021	67
792P0DS1	29	7K2C3N07	205	7T6F0N25XL	51	89-3A020	67	89-6A021N	67
792P0DS3	29	7K2C3N10	205	7T7F0N20	109	89-3A020-172	67	89-6A024	67
793C3N05	83	7K2C3N12	205	7T7F0N25	109	89-3A020-B	67	89-6A026	67
793C3N07	83	7K2C7N12	207	7T7F0N30	109	89-3A020-T	67	89-6A029	67
793C3N10	83	7K3C3N05	207	7T7F0N35	109	89-3A020-T-172	67	89-6A126	63
793C3N12	83	7K3C3N07	207	7T7F0N40	109	89-3A021	67	89-6A219-172	66
793C7N05	61	7K3C3N10	207	7X1C3N07	77	89-3A021N	67	89-6A229-172	67
793C7N07	61	7K3C3N12	225	7X1C3N10	77	89-3A024	67	89-6A523	67
793C7N10	61	7K3C7N05	207	7X1F0N10	79	89-3A026	67	89-6A925	67

Part number	Pg	Part number	Pg	Part number	Pg	Part number	Pg
89-91***-MTR	181	CG1001AM	178	CG2005A	178	TMC2-***	179
89-94042	64	CG1001P	178	CG2005AM	178		
89-94043	64	CG1002A	178	CG2006A	178		
89-94045	64	CG1002AM	178	CG2006AM	178		
89-94047	64	CG1002P	178	CG2121A	178		
89-94072	64	CG1003A	178	CG2121AM	178		
89-94073	64	CG1003P	178	CG2122A	178		
89-94075	64	CG1004P	178	CG2122AM	178		
89-94076	64	CG1121A	178	CG2123A	178		
89-94142	64	CG1121AM	178	CG2123AM	178		
89-94143	64	CG1121P	178	CG3001A	178		
89-94147	64	CG1122A	178	CG3001AM	178		
89-94162	64	CG1122AM	178	CG3002A	178		
89-94163	64	CG1122P	178	CG3002AM	178		
89-94165	64	CG1123A	178	CG340A	178		
89-94167	64	CG1123AM	178	CG340AM	178		
89-98042	64	CG1124A	178	CG340P	178		
89-98043	64	CG1124AM	178	CG340PM	178		
89-98045	64	CG1141A	178	CG341A	178		
89-98047	64	CG1141AM	178	CG341AM	178		
89-98072	64	CG1141P	178	CG341P	178		
89-98073	64	CG1142A	178	CG341PM	178		
89-98075	64	CG1142AM	178	CG342A	178		
89-98076	64	CG1142P	178	CG342AM	178		
89-98142	64	CG1143A	178	CG342P	178		
89-98143	64	CG1143AM	178	CG342PM	178		
89-98147	64	CG1143P	178	CG344A	178		
89-98162	64	CG1144A	178	CG344AM	178		
89-98163	64	CG1144AM	178	CG344P	178		
89-98165	64	CG121A	178	CG344PM	178		
89-98167	64	CG121AM	178	CG345A	178		
89-9A010	66	CG121P	178	CG345AM	178		
89-9A010-174	66	CG121PM	178	CG345P	178		
89-9A010-B	66	CG122A	178	CG345PM	178		
89-9A010-T	66	CG122AM	178	CPF403	138		
89-9A010-T-174	66	CG122P	178	CPF405	138		
89-9A011	66	CG122PM	178	DS1PC	41		
89-9A014	66	CG123A	178	DS2MC	51		
89-9A019	66	CG123AM	178	DS3PC	43		
89-9A020	67	CG123P	178	DS6MC	45		
89-9A020-174	67	CG123PM	178	DS6PC	45		
89-9A020-B	67	CG124A	178	DS9MC	49		
89-9A020-T	67	CG124AM	178	FB-63-*****	164		
89-9A020-T-174	67	CG124P	178	FBSS-63-*****	165		
89-9A021	67	CG124PM	178	FBW-63-*****	164		
89-9A021N	67	CG125A	178	FBWSS-63-*****	165		
89-9A024	67	CG125AM	178	LP-843	27		
89-9A026	66	CG125P	178	MB40-XX	135		
89-9A029	67	CG125PM	178	MB40PFQ-XX	135		
89-9A126	65	CG2001A	178	PFLUG**	136		
89-9A219-174	66	CG2001AM	178	RBT1*	157		
89-9A229-174	67	CG2001P	178	RBT2*	158		
89-9A523	67	CG2002A	178	RBT3*	159		
89-9A925	67	CG2002AM	178	SB-1*****	247		
CB-63-*****	166	CG2002P	178	SB-2*****	247		
CBSS-63-*****	167	CG2003A	178	SB-3*****	247		
CBW-63-*****	166	CG2003AM	178	SB-5*****	247		
CBWSS-63-*****	167	CG2003P	178	SB-7*****	247		
CD****	179	CG2004A	178	SD18	27		
CG1001A	178	CG2004AM	178	TC-***	179		

Complimentary Products

For complimentary Hazardous Location products visit technor.com.

Lighting



Control Stations



Junction Boxes



Flameproof Enclosures



Earthing Systems



Visual Signals



Cable Glands & Fittings



 **Technor**[®]
A COMPANY OF MARECHAL ELECTRIC





WORLD PRESENCE

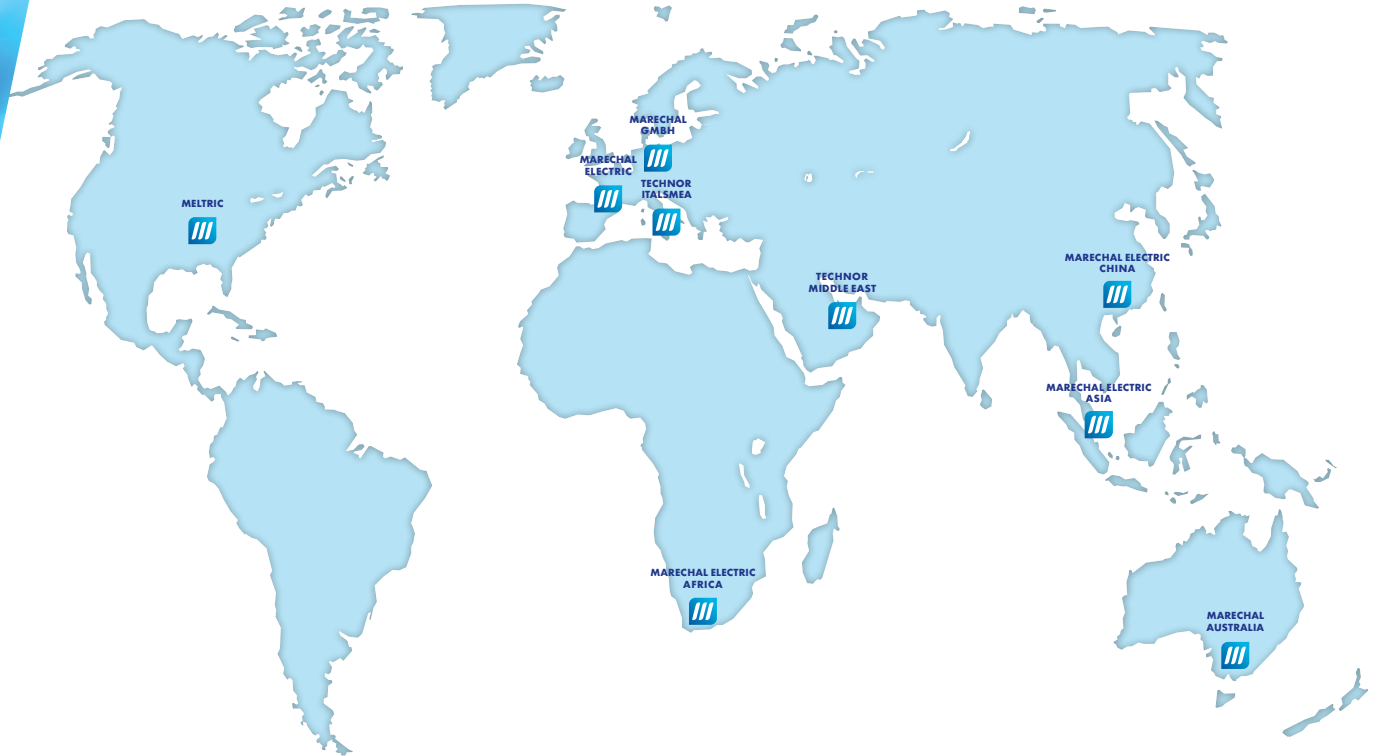

USA/Canada/Mexico
MELTRIC Corporation
 4765 W. Oakwood Park Drive
 Franklin WI 53132, USA
 Tel.: 414 433 2700
 Fax: 414 433 2701
 e-mail: mail@meltric.com

Africa SADC area
MARECHAL ELECTRIC AFRICA (PTY) LTD.
 PO Box 13875 Witfield 1467
 Unit A1 Harvard Lane
 Aero Star Business Park
 Jet Park Road, Jet Park
 South Africa
 Tel.: +27 11 894 7226/7/8
 Fax: 086 604 1778
 e-mail: sales.za@marechal.com

Asia
MARECHAL ELECTRIC Asia Pte Ltd
 9 Tagore Lane
 #01-05 9@Tagore
 Singapore 787472
 Tel.: +65 6554 2722
 Fax: +65 6455 9077
 e-mail: sales.asia@marechal.com

Australia
MARECHAL AUSTRALIA PTY LTD
 20 Technology Circuit
 HALLAM VIC 3803
 Tel: +61 1300 661 830
 Fax: +61 1300 663 510
 e-mail : sales@marechal.com.au

Chine
MARECHAL ELECTRIC (CHINA) Co., Ltd
 11 North Xiangshui Road,
 West Dayawan District,
 Huizhou.P.R.C
 Tel/Fax: +86 (0)752-5319536
 e-mail : sales.cn@marechal.com

Germany/Austria/Switzerland/ East Europe/Russia
MARECHAL GmbH
 Im Lossenfeld 8
 D-77731 Willstätt-Sand
 Germany
 Tel.: +49 (0)7852/91 96-0
 Fax: +49 (0)7852/91 96-19
 e-mail: info.de@marechal.com

Middle East
Technor Middle East DMCC
 Unit No.2101, Fortune Executive
 Tower, Plot No T1
 Jumeirah Lakes Towers
 P.O. Box 392054
 Dubai, United Arab Emirates
 Tel.: +971 4 362 1418
 Fax: +971 4 362 1419
 e-mail: sales.me@marechal.com

Marechal Electric (Head Office)
 5, avenue de Presles
 F-94417 Saint-Maurice Cedex
 Phone : +33 (0)1 45 11 60 00
 Fax : +33 (0)1 45 11 60 60
 e-mail: contact@marechal.com

TECHNOR
TECHNOR ITALSMEA S.p.A.
 Via Italia 33,
 20060 Gessate (MILANO)
 Tel.: +39 02 95 38 04 06
 Fax: +39 02 95 38 08 58
 e-mail: sales.it@marechal.com

For any other country or area, please contact head office.

CATALOG 2018